

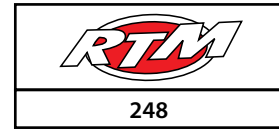

İNDEKS

MRK Serisi Ray Klemensler (Vidalı)	6 - 12	Akım Trafoları	142 - 144
OPK Serisi Ray Klemensler (Push-in Sistem)	13 - 19	Reaktörler	145 - 147
MPK Serisi Ray Klemensler (Push-in Sistem)	20 - 21	Trafolar (Monofaze - Trifaze)	148 - 149
Pano Topraklama Klemensleri	22	Güç Kaynakları	150 - 153
Dağıtıcı Üniteler	23 - 26	Termokupllar	154 - 157
W Otomat Baraları	27 - 29	Sensörler	158 - 161
Motor Koruma Baraları	30	Fotoseller ve Kablo Konnektörleri	162 - 163
Güç Klemensleri (Modüler)	30	Solid State Röleler	164 - 165
Bakır Bara Bağlantı Klemensleri	31	Hız Kontroller, Servo Motorlar ve Servo Sürücüler	166 - 168
Vidalı Topraklama Baraları	31	Endüstriyel Tip Fiş Soketler	169 - 170
Raylar ve Aksesuarları	32 - 35	Baskılı Devre Klemensleri	171 - 176
SKP Papuçlar	36 - 42	Klemensler İçin Şerit Markalama Sistemi	177
Bimetalik SKP ve Bimetalik Ek Muflar	43 - 47	Endüstriyel Tip, Genel Amaçlı ve Sarmal Kablo Etiketleri	178
Ek Muflar	48 - 49	Klemensler İçin Plotter Yazıcı ile Dekafix Markalama Sistemi	179
U, H, C, Tırnaklı, Kondansatör Klemensleri	50	Brady Yazıcılar ve Etiketleme Sistemleri	180 - 188
Alcu Klemensler, Branşman ve Durdurucu Klemensler	51	Kilitler (Şalter, Sigorta ve Butonlar İçin)	189 - 190
Trafo, Modül Cihaz ve Mini Klemensler	52	Isıyla Daralan Makaronlar	191 - 192
Steatit Klemensler	53	Kablo Toplama Çorapları ve Spiralleri	193
Sıra Klemensler	54 - 56	Cam Elyaf ve Silikon İzoleli Makaronlar	193
Soket Klemensler	57	Çift Taraflı Bantlar ve Bant Çeşitleri	194
Buat İçerikli Baskılı Klemensler	58	Pano Isıtıcı ve Termostatları	195
Vidalı Şeffaf Buat İçerikli Klemensler (Renkli)	59	Fanlar, Havalandırma Filtreleri ve Panjurları, Proje Cepleri	196
Vidalı-Yivli (Kulaklı ve Kulaksız) / Yüksüklü Buat Klemensler	59	Asansör Dünyası	197 - 217
Geçmeli Buat İçerikli Klemensler (Renkli ve Şeffaf)	60	Porselen Sigortalar ve Sigorta Yuvaları	218 - 219
Aç-Kapa Buat Klemensleri	60 - 61	Yük Kesici ve Sigorta Yuvası	220
Pratik Bağlantı Klemensleri (I ve T Tipi)	62 - 63	Pano İçerikli Led Aydınlatma Armatürleri	221 - 223
KC Tipi Kablo Etiketleri	64 - 65	Anahtar, Buton, Sinyal ve Switchler	226 - 231
Kablolar İçin İşaretleme Etiket Yatağı	66	Güç Kontaktörleri ve Termik Röleler	232
Kablo Bağlı Tutucuları ve Etiket Taşıyıcıları	66	Basınç Şalterleri (Monofaze / Trifaze)	236 - 237
Pano Sinyal ve Buton Etiketleri	67	Motor Aksesuarları	238
Pano Etiketleri (Yapışkanlı ve Vidalı)	67	Fiş Prizler (Monofaze, Trifaze)	240 - 242
W Otomat Örtme Aparatı	67	İkaz Lambaları ve Sirenler	243 - 244
Pano Prizleri	68	Polyester, Etanj ve Taban Saclı Panolar	249
Rakorlar ve Aksesuarları	69 - 72	İşaret, Uyarı ve İkaz Levhaları	250 - 251
Kablo Kanalları	73 - 75	Ölçü Aletleri	252 - 256
Yüksük ve Kablo Uçları	76 - 88	Reçineli ve Isı Büzüşmeli Kablo Ek Mufları	257 - 262
Terminaler ve Kılıfları	89 - 90	Sprey Çeşitleri	263
Kablo Bağları ve Aksesuarları	91 - 100	Exproof Endüstriyel Tip Ürünler	264 - 265
Elektronik Devreli Klemensler	101 - 103	Pirinç Rakor Çeşitleri	266
Lamba Test ve Optokupler Modüller, Diyot Kartları	104 - 105	Geçmeli Tip Rakor ve Spiral Hortumlar	267 - 268
Röle Kartları	106	Vida, Dübel, Kroşe ve Sustalar	269
Röleler (ONKA, Sloke, Kael, Shenler)	107 - 118	Piller ve El Fenerleri	270 - 271
Güç Dağıtım Blokları (FTG, xkdq ve mavi kapaklı dağıtıcılar)	119 - 129	Aspiratörler	272 - 273
İzolatörler	130 - 134	Regülatörler	274
Askı Aparatı, Orta Gerilim Hücre Kablo Tutucu ve Körüğü	135	El Aletleri	275 - 302
Cam Elyaf Plakalar	135	Paratoner ve Topraklama Ekipmanları	303
Kondansatörler ve Orta Gerilim Sigortası	136 - 141	Orta Gerilim Malzemeleri	304

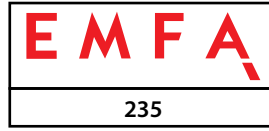

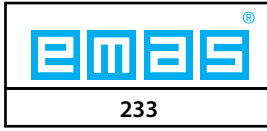
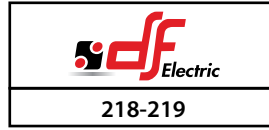
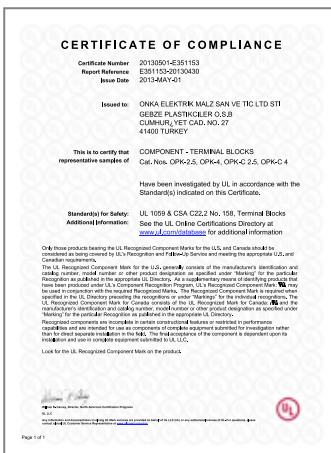

ÜLKE İSİMLERİ OLACAK

TEKNİK BİLGİLER

TS 3033 EN 60529'a Göre IP Koruma Sınıfları				TS EN 62262 Ye Göre Darbe Koruma Dereceleri	
BİRİNCİ RAKAM	KATI CİSİMLERE KARŞI KORUMA	İKİNCİ RAKAM	KATI MADDELERE KARŞI KORUMA	IK	Darbe Koruma Derecesi
0	Koruma Yok	0	Koruma Yok	00	0
1	50 mm'den büyük boyutlardaki katı cisimlere karşı koruma	1	Dik düşen su damllarına karşı koruma	01	0,15
2	12,5 mm'den büyük boyutlardaki katı cisimlere karşı koruma	2	Düşey'le 15' lik açı yapan su damllarına karşı koruma	02	0,20
3	2,5 mm'den büyük boyutlardaki katı cisimlere karşı koruma	3	Düşey'le 60' lik açıdan daha büyük açı oluşturan su damllarına karşı koruma	03	0,35
4	1 mm'den büyük boyutlardaki katı cisimlere karşı koruma	4	Her yönden gelen su damllarına karşı koruma	04	0,50
5	Toza karşı koruma	5	Her yönden , hortum marpuçundan püsküren su fişkırtmalarından koruma	05	0,70
6	Toza karşı tam koruma	6	Her yönden şiddetli deniz dalgalarına benzer şekilde çarpan suların etkisine karşı tam koruma	06	1
-	-	7	Suya gömülme durumunda etkilerinden koruma.	07	2
-	-	8	Belirlenmiş koşullar altında uzun sürelerde suya gömülme durumunun etkilerinden koruma	08	5
-	-	-	-	(1)	6
-	-	-	-	09	10
-	-	-	-	10	20

STANDART TERMİNALLERİN AKIM TAŞIMA KAPASİTESİ ve Vidalı Terminaller İçin SIKMA TORK CETVELİ

Boyut mm ²	Boyut AWG/kcmil	AKIM TAŞIMA KAPASİTESİ (AMPER)	Vida Ölçüsü (Metrik)	SIKMA TORKU (Nm)
0,2	24	4	.	.
0,34	22	5	.	.
0,5	20	6	.	.
0,75	18	9	.	.
1	.	13,5	.	.
1,5	16	17,5	2,5	0,4
2,5	14	24	2,5	0,4
4	12	32	3	0,5
6	10	41	3,5	0,8
10	8	57	3,5	0,8
16	6	76	5	2
25	4	101	.	.
35	2	125	5	2
50	0	150	8	6
70	00	192	8	6
95	000	232	8	6
-	0000	-	-	-
120	250 kcmil	269	8	6
150	300 kcmil	309	-	-
185	350 kcmil	353	-	-
240	500 kcmil	425	-	-
300	600 kcmil	520	-	-

KAYNAK : EMO-2020 ve EN 60947-7-1 direktifleri

Metrik boyut ISO mm ²	"AWG/kcmil ile metrik boyutlar arasındaki karşılaştırma"	
	Boyut AWG/kcmil	"Eş değer metrik alan"
0,2	24	0,205
0,34	22	0,324
0,5	20	0,519
0,75	18	0,82
1	.	.
1,5	16	1,3
2,5	14	2,1
4	12	3,3
6	10	5,3
10	8	8,4
16	6	13,3
25	4	21,2
35	2	33,6
50	0	53,5
70	0	67,4
95	0	85
-	0	107,2
120	250 kcmil	127
150	300 kcmil	152
185	350 kcmil	177
240	500 kcmil	253
300	600 kcmil	304

Bağlantı ucu bloklarının beyan kesiti ile beyan bağlama kapasitesi arasındaki ilişki			
BEYAN KESİT		EN 60947-7-1'e göre bağlantı ucu bloğunun bağlayabileceği iletken kesiti	
mm ²	AWG	mm ²	AWG
0,2	24	0,2	24
0,34	22	0,2-0,34	24-22
0,5	20	0,2-0,34-0,5	24-22-20
0,75	18	0,34-0,5-0,75	22-20-18
1	-	0,5-0,75-1	-
1,5	16	0,75-1-1,5	20-18-16
2,5	14	1-1,5-2,5	18-16-14
4	12	1,5-2,5-4	16-14-12
6	10	2,5-4-6	14/12/10
10	8	4-6-10	12-10-8
16	6	6-10-16	10-8-6
25	4	10-16-25	8-6-4
35	2	16-25-35	6-4-2

PANO İÇİNDE KULLANILAN H05... (NYAF) KABLO TEKNİK ÖZELLİKLERİ

NYAF	Nominal Kesit	Kablo Dış Çapı	Net Ağırlık	Akım Taşıma Kapasitesi (AKIM) 30 °C		Sevk Uzunluğu
	mm ²	mm	kg/km	Boru İçinde	Havada	mt
H05-VK	0,5	2	9	12	100
	0,75	2,2	11	...	15	100
	1	2,5	14	19	100
H07-VK	1,5	2,8	19	14,5	24	100
	2,5	3,5	30	19,5	32	100
	4	4	44	26	42	100
	6	4,4	62	34	54	100
	10	5,7	110	46	73	100
	16	7,2	167	61	98	100
	25	8,6	262	80	129	100
	35	10,2	350	99	158	1000
	50	12,2	510	119	198	1000
	70	13,9	677	151	245	1000
	95	15,7	891	182	292	1000
	120	17,5	1109	210	344	1000
	150	19,2	1371	240	391	1000
	185	21,1	1695	273	448	1000
240	23,5	...	320	528	1000	

KAYNAK : EMO-2020 ve EN 60947-7-1 direktifleri

BAKIR BARALAR ÇEVRE SICAKLIĞI 35 °C ISINMA 30 °C

BOYUTLAR	KESİT	AĞIRLIK	BOYALI BARA ADEDİ				ÇIPLAK BARA ADEDİ			
			1	2	3	4	1	2	3	4
12x2	23,5	0,209	125	225	-	-	110	200	-	-
15x2	29,5	0,262	155	270	-	-	140	240	-	-
15x3	44,5	0,396	185	330	-	-	170	300	-	-
20x2	39,5	0,351	205	350	-	-	185	315	-	-
20x3	59,5	0,529	245	425	-	-	220	380	-	-
20x5	99,1	0,882	325	560	-	-	295	500	-	-
25x3	74,5	0,663	300	520	-	-	270	460	-	-
25x5	124	1,11	395	670	-	-	350	600	-	-
30x3	89,5	0,796	355	610	-	-	315	540	-	-
30x5	149	1,33	450	780	-	-	400	700	-	-
40x3	119	1	460	790	-	-	420	710	-	-
40x5	199	1,77	600	1000	-	-	520	900	-	-
40x10	399	3,55	850	1500	2060	2800	760	1350	1850	2500
50x5	249	2,22	720	1220	1750	2300	630	1100	1650	2100
50x10	499	4,44	1030	1800	2450	3330	920	1600	2250	3000
60x5	299	2,66	850	1430	1950	2650	760	1250	1760	2400
60x10	599	5,33	1200	2100	2800	3700	1060	1900	2600	3500
80x5	399	3,55	1070	1900	2500	3200	970	1700	2300	3000
80x10	799	7,11	1560	2500	3300	4500	1380	2300	3100	4200
100x5	499	4,44	1350	2300	3000	3800	1200	2050	2850	3500
100x10	999	8,89	1880	3100	4000	5400	1700	2800	3650	5000
120x10	1200	10,7	2200	3500	4500	6100	2000	3100	4100	5700
160x10	1600	14,2	2800	4400	5800	7800	2500	3900	5300	7300
200x10	2000	17,8	3350	5300	6900	9400	3000	4750	6350	8800

ALÜMİNYUM BARALAR ÇEVRE SICAKLIĞI 35 °C ISINMA 30 °C

BOYUTLAR	KESİT	AĞIRLIK	BOYALI BARA ADEDİ				ÇIPLAK BARA ADEDİ			
			1	2	3	4	1	2	3	4
12x2	23,5	0,0633	95	170	-	-	75	135	-	-
15x2	29,5	0,0795	120	205	-	-	90	160	-	-
15x3	44,5	0,12	140	250	-	-	110	200	-	-
20x2	39,5	0,107	155	265	-	-	1150	210	-	-
20x3	59,5	0,161	185	325	-	-	140	255	-	-
20x5	99,1	0,268	245	420	-	-	185	330	-	-
25x3	74,5	0,201	230	390	-	-	170	315	-	-
25x5	124	0,335	295	510	-	-	220	410	-	-
30x3	89,5	0,242	265	435	-	-	195	365	-	-
30x5	149	0,403	340	595	-	-	255	475	-	-
40x3	119	0,323	350	600	-	-	265	475	-	-
40x5	199	0,538	435	760	-	-	330	620	-	-
40x10	399	1,08	635	1140	1570	2140	490	925	1280	1700
50x5	249	0,673	530	920	1330	1760	405	740	1070	1430
50x10	499	1,35	780	1370	1860	2530	595	1090	1520	2050
60x5	299	0,808	635	1100	1520	2020	475	855	1240	1640
60x10	599	1,62	910	1600	2170	2890	695	1260	1800	2380
80x5	399	1,08	835	1430	1900	2470	645	1110	1570	2120
80x10	799	2,16	1190	2030	2720	3600	890	1620	2240	3000
100x5	499	1,35	1030	1790	2330	2950	780	1370	1900	2470
100x10	999	2,7	1440	2420	3250	4100	1100	1950	2650	3500
100x15	1500	4,04	1760	2900	3800	4900	1400	2400	3200	4200
120x10	1200	3,24	1710	2850	3650	4750	1300	2280	3100	4100
120x15	1800	4,86	2070	3360	4400	5400	1550	2750	3700	4750
160x10	1600	4,32	2200	3600	4750	5900	1650	2850	3950	5050
160x15	2400	6,47	2600	4250	5450	7050	2000	3400	4600	5950
200x10	2000	5,4	2850	4600	5900	7500	2150	3650	4950	6400
200x15	3000	8,09	3300	5200	6550	8200	2550	4200	5600	7300

KAYNAK : EMO-2020 ve EN 60947-7-1 direktifleri

ISI BÜZÜŞMELİ MAKARONLAR/ HEAT SHRINKABLE TUBES

TERCİH EDİLEN RENK KODU SİPARİŞ ESNASINDA ÜRÜN KODUNA İLAVE EDİLMELİDİR.

11 Siyah	12 Sarı/Yeşil	13 Kırmızı	14 Sarı	15 Mavi	16 Yeşil	17 Gri	18 Kahve	19 Beyaz	20 Şeffaf
ÜRÜN KODU	ÜRÜN YUVARLAK BORU FORMUNDA İÇ ÇAP DARALMA ÖNCESİ (mm)	ÜRÜN YUVARLAK BORU FORMUNDA İÇ ÇAP DARALMA SONRASI (mm)	Dikdörtgen kesitli BARAYA UYGUNLUK (mm)	Kablo ve Pabucuna Uygunluk 1 damar kesiti (mm ²)	PAKET RULO MİKTARI (mt)				
MAK 01.5	1,5	0,75		1 mm ve altı	200				
MAK 02.5	2,5	1,25		0,5-0,75	200				
MAK 03.5	3,5	1,75		0,75-1-1,5	200				
MAK 04.5	4,5	2,25		1,5-2,5	100				
MAK 05.0	5	2,5		2,5	100				
MAK 06.0	6	3		4-6	100				
MAK 07.0	7	3,5		6	100				
MAK 08.0	8	4		6-10	100				
MAK 10	10	5		10-16	100				
MAK 12	12	6		10-16	100				
MAK 13	13	6,5	12X2-15X2-15X3	16-25	100				
MAK 16	16	8	20X2-20X3	16-25-35-50	100				
MAK 18	18	9	20X5	35-50	100				
MAK 20	20	10	20X5-25X3-25X5	70	100				
MAK 22	22	11	25X5-30X3-30X5	70-95	100				
MAK 25	25	12,5	25X5-30X3-30X5	70-95	50				
MAK 28	28	14	40X3	70-95	50				
MAK 30	30	15	40X3-40X5	120	50				
MAK 32	32	16	30X10-40X5	120-150	50				
MAK 35	35	17,5	30X10-40X5-40X10	150	50				
MAK 38	38	19	40X5-40X10	185-240	50				
MAK 40	40	20	50X5	185-240-300	50				
MAK 45	45	22,5	50X5-50X10	240-300-400	25				
MAK 50	50	25	60X5-60X10	400	25				
MAK 60	60	30	80X5-80X10		25				
MAK 70	70	35	100X5-100X10		25				
MAK 80	80	40	100X5-100X10		25				
MAK 90	90	45	100X10		25				
MAK 100	100	50	120X10		25				
MAK 120	120	60	120X10-160X10		25				
MAK 150	150	75	160X10		25				

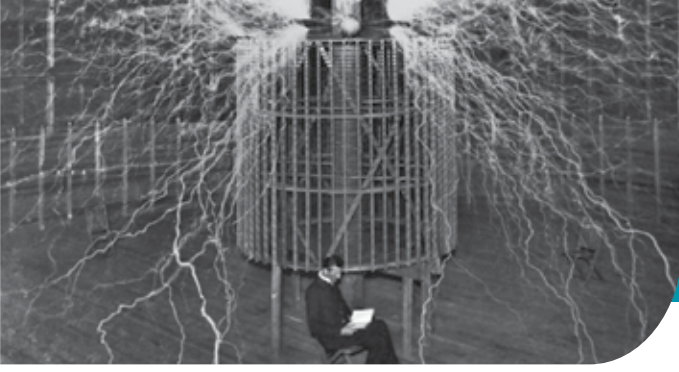

YENİ ÜRÜNLERİMİZ

OPK Serisi

Yeni OPK Çok Katlı Push-in
Bağlantılı 4 Giriş + 4 Çıkış
3L + N / 3L + Pe

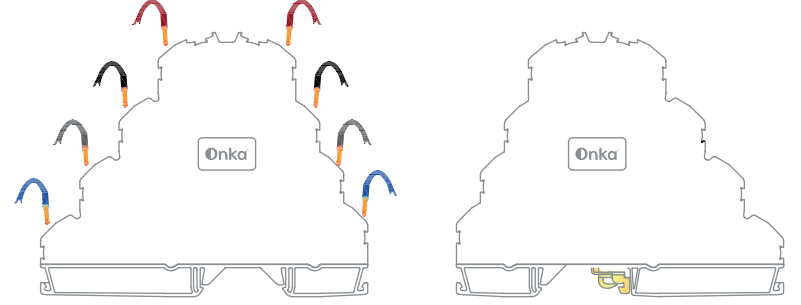

Vidalı ve Yay Baskılı Ray Klemens

1 Yönü yay, diğer yönü vida
bağlantılı 2,5 - 4 mm²

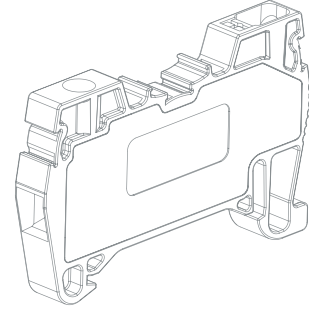

MRK Serisi

Yeni MRK Çok Katlı Vida
Bağlantılı 3 Giriş + 3 Çıkış
3L + N / 3L + Pe

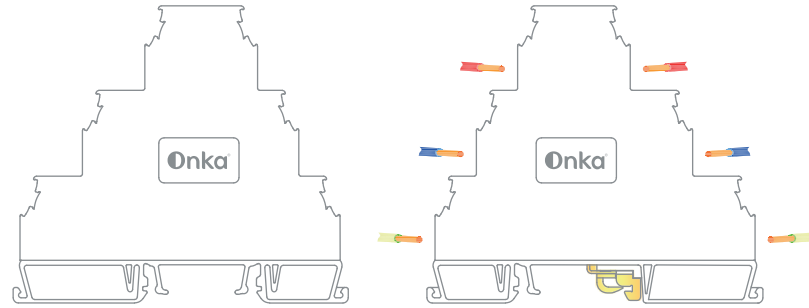

OPK Serisi Soketli

Soketli Ray Klemens
2,5 - 4 mm²

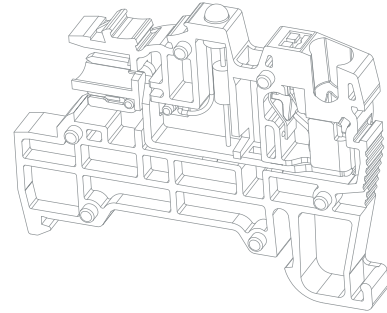

Mühürlenebilir Koruma Ka a ğı

DIN Rayına Montajlı,
Projeye Göre Boyutlandırılabilir,
Mühürlenebilir.

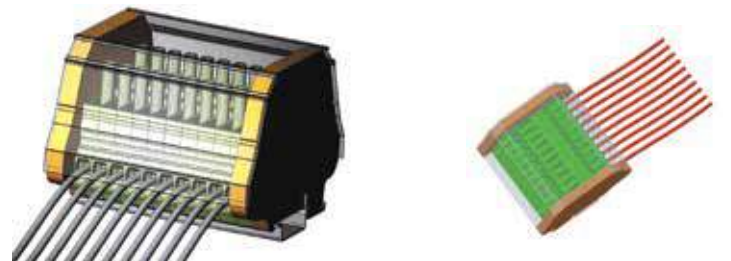

11 mm PVC Şerit Etiket Takılabilir.

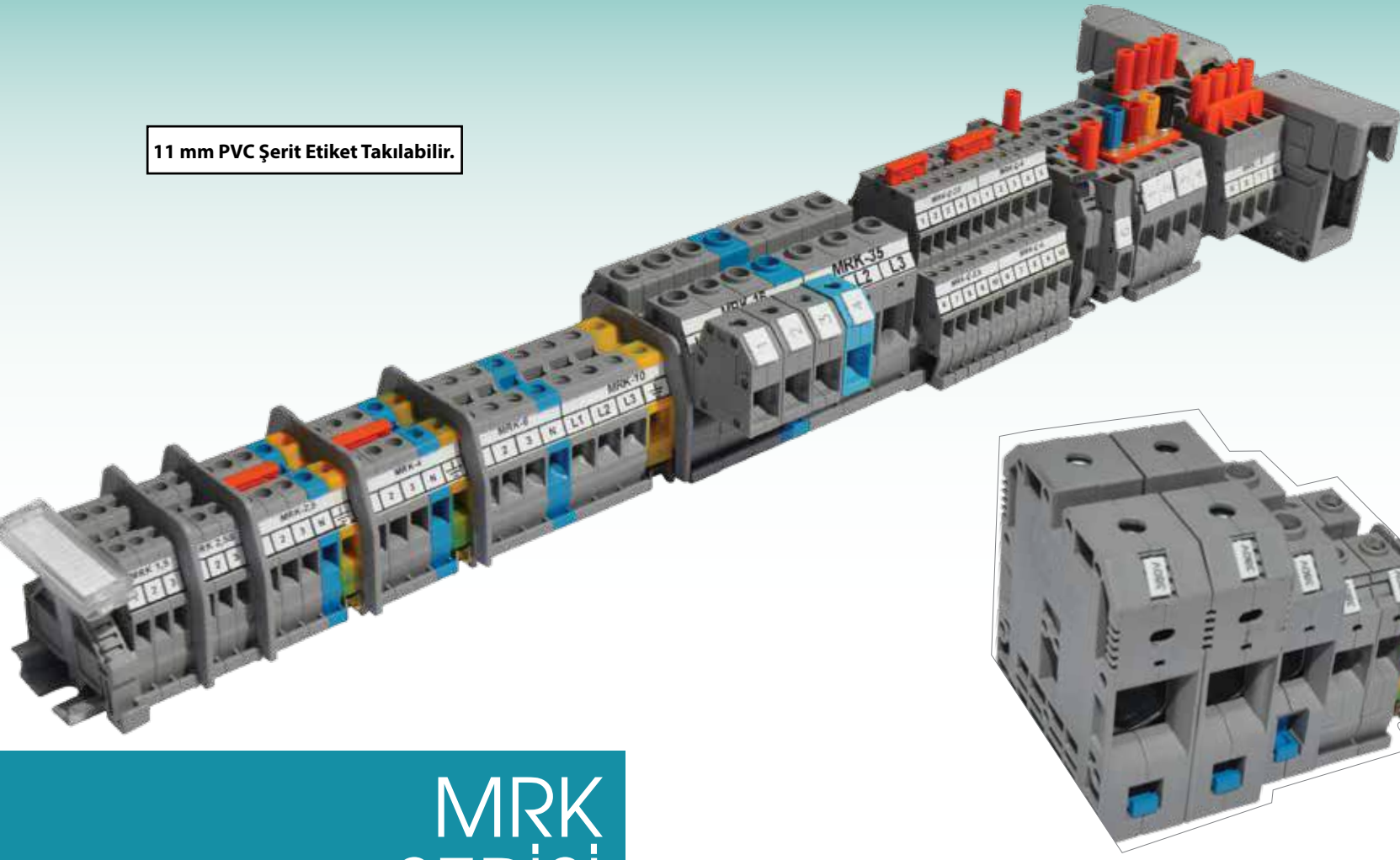

MRK SERİSİ

Vida Baskılı Ray Klemensler

- Nihayet plakası gerektirmez. (Her iki tarafı kapalı)
- Daha iyi bir izolasyon ve maliyet avantajı sağlar.
- Simetriktir. (Her iki yönde raya monte edilebilir)
- 0,06 mm² den 240 mm² kablo kesitine kadar montaj imkanı sağlar.
- Markalama yapısı evrensel olarak tüm markalama ekipmanlarına uygun tasarlanmıştır.
- Şerit etiketlemeye de uygun markalama yapısı.
- Çift yönlü köprüleme imkanı.
- 1,5 mm² den 10 mm² ye kadar izoleli tarak köprü kullanılabilir.
- Vida sistemi 1,5 mm² den 35 mm² ye kadar düz başlı, 50 mm² ve sonraki kesitlerde alyan başlıdır.
- Slim serilerle ergonomik ve kompakt tasarımlara imkan sağlayarak montaj alanını minimize eder.



• Yeni MRK Serisinde 1.5 mm²'den 35 mm² kesite kadar şerit etiketleme sistemi uygulanabilir.

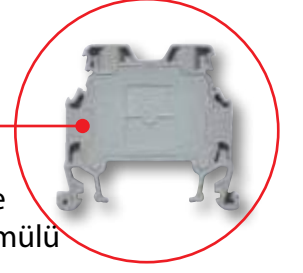

• Ana gövde tek parça ve nihayet plakası içine gömülü olarak üretilmiştir.



• MRK Serisinde 1.5 mm²'den 10 mm² ye kadar yeni üst köprü sistemi kullanılmıştır.

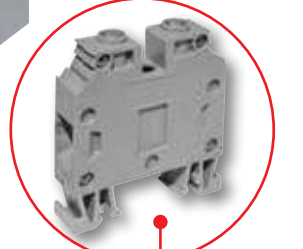
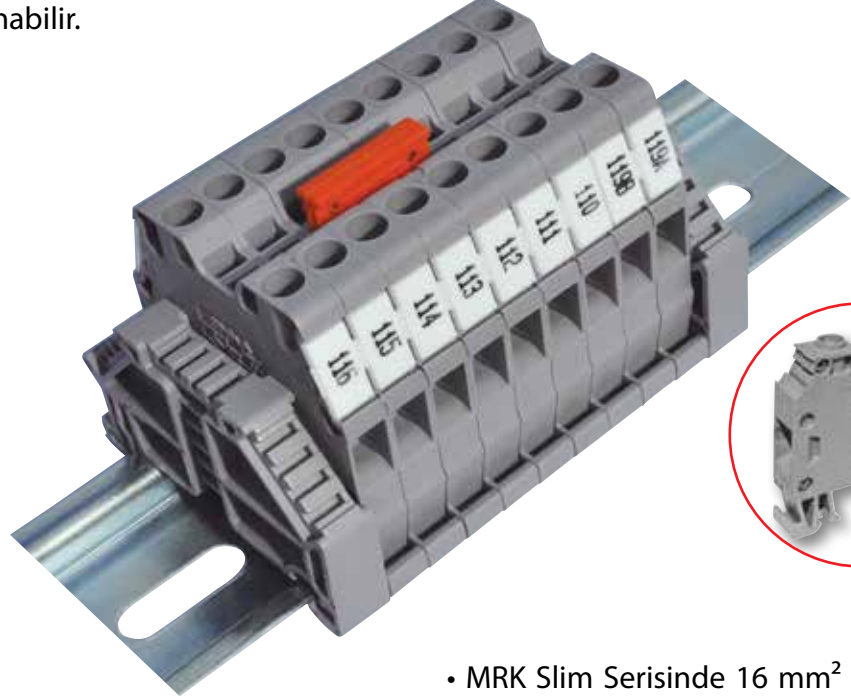

• MRK Slim Serisinde 16 mm² ve 35 mm² klemenslerin ebatları minimize edilmiştir. MRK 16 (51 x 54 x 12) mm, MRK 35 (51 x 54 x 15) mm ebatlarındadır.
• Yeni MRK 16 ve 35'te klemensin gövdesi ve kapağı birbirine 4 adet çelik vida ile sabitlenmiştir.

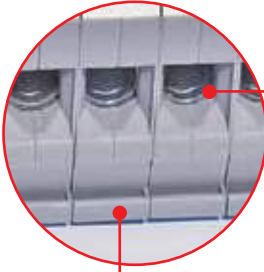

• MRK 6-10-16 ve 35'in kovan sisteminin alt kısmındaki U formu sayesinde kovanın kabloya daha fazla teması sağlanmıştır.

• MRK 16 ve 35'in raya montaj ayaklarının gövde genişliğinde olması sayesinde ray üzerinde daha geniş ve rijit kavrama, güvenli ve sağlam montaj imkanı.

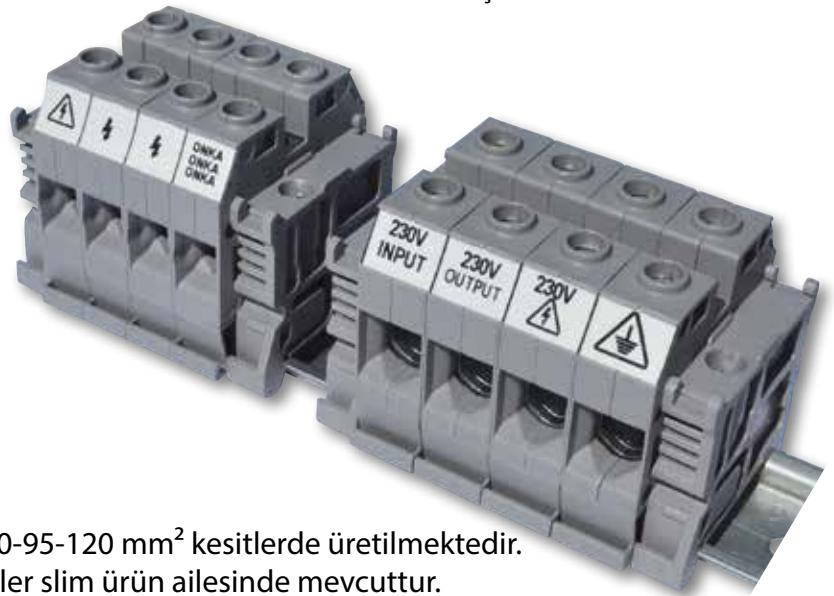

- MRK Serisi 1.5-2.5-4-6-10-16-35-50-70-95-120 mm² kesitlerde üretilmektedir.
- MRK Serisinde 2.5-4-16-35 mm² kesitler slim ürün ailesinde mevcuttur.
- Klemens içerisindeki bakır bara ve kovan iç çeperinde yapılan setler, montajı tamamlanan iletken üzerinde maksimum güvenli bağlantı sağlar.
- MRK 16 ve 35'in köprüleme sistemi vidalı üst köprüdür.

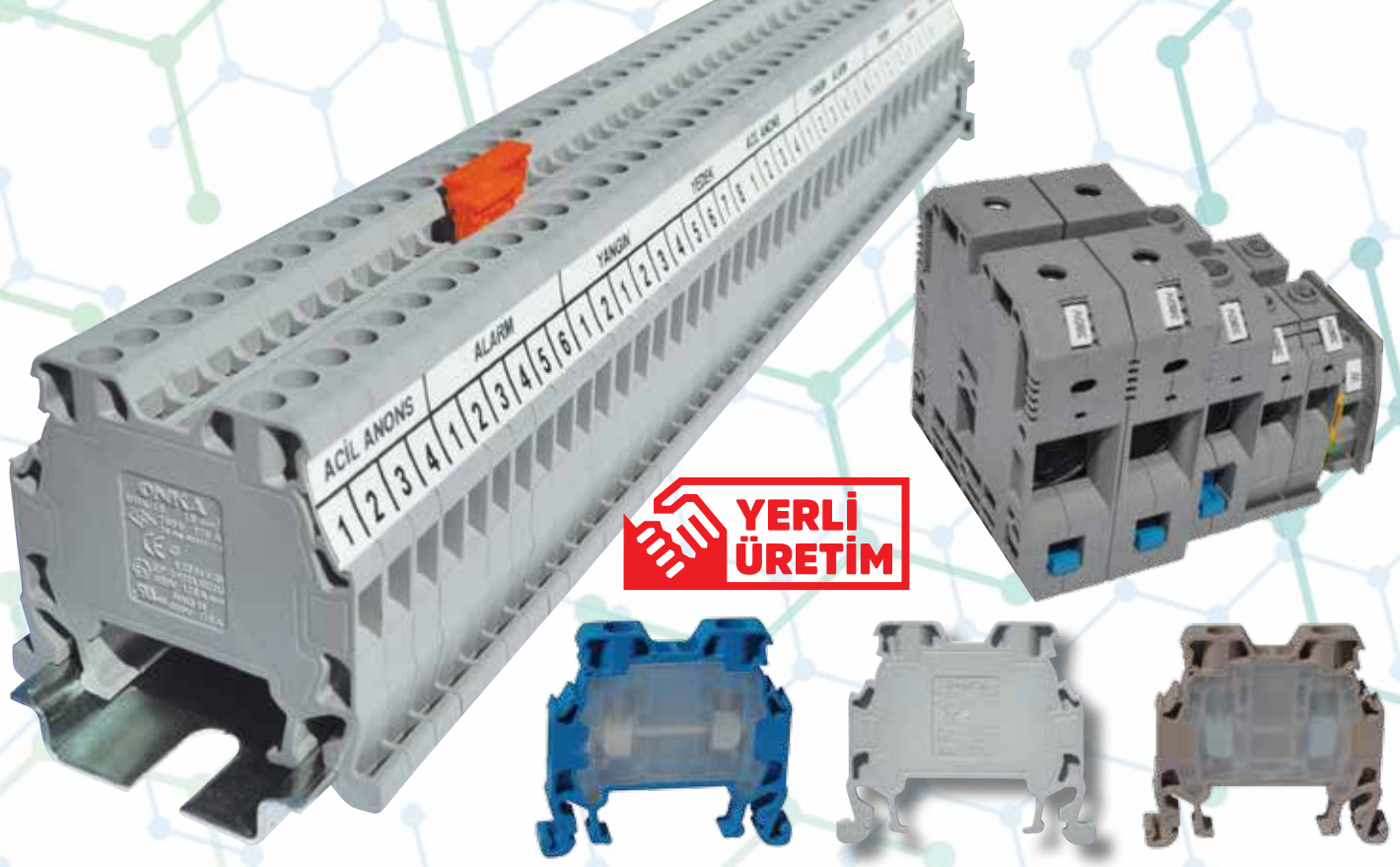

MRK SERİSİ VİDA BASKILI RAY KLEMENSLER (HER İKİ TARAFI KAPALI SİSTEM)

KOD	CİNSİ	KABLO KESİTİ	GERİLİM (V)	AKIM (A)	AD. / ʈ	KOD (VO YANMAZ)	AD. / ʈ (VO YANMAZ)	K. AD.
ONKA-1002	MRK - 1,5 mm ²	1,5 mm ²	750V	17,5 A	2,76	ONKA-0752	3,21	100
ONKA-1012	MRK - 2,5 mm ²	2,5 mm ²	750V	24 A	3,21	ONKA-0762	3,52	100
ONKA-1022	MRK - 4 mm ²	4 mm ²	750V	32 A	3,33	ONKA-0772	3,79	100
ONKA-1032	MRK - 6 mm ²	6 mm ²	750V	41 A	4,59	ONKA-0782	5,07	100
ONKA-1042	MRK - 10 mm ²	10 mm ²	750V	57A	5,14	ONKA-0792	5,70	100
ONKA-1052	MRK - 16 mm ²	16 mm ²	750V	76 A	13,81	ONKA-0802	16,77	50
ONKA-1062	MRK - 35 mm ²	35 mm ²	750V	125 A	19,04	ONKA-0812	22,52	30
ONKA-1072	MRK - 50 mm ²	50 mm ²	750V	150 A	48,85	ONKA-0822	54,32	20
ONKA-1082	MRK - 70 mm ²	70 mm ²	750V	192 A	54,59	ONKA-0832	60,63	20
ONKA-1092	MRK - 95 mm ²	95 mm ²	1000 V	232 A	97,25	ONKA-0842	110,36	10
ONKA-1102	MRK - 120 mm ²	120 mm ²	1000 V	269 A	110,56	ONKA-0852	125,83	10

MRK SLIM SERİ VİDA BASKILI RAY KLEMENSLER (HER İKİ TARAFI KAPALI SİSTEM)

KOD	CİNSİ	KABLO KESİTİ	GERİLİM (V)	AKIM (A)	AD. / ʈ	KOD (VO YANMAZ)	AD. / ʈ (VO YANMAZ)	K. AD.
ONKA-0902	MRK - 2,5 mm ² SLIM SERİ	2,5 mm ²	750V	24 A	2,76	ONKA-0862	3,21	100
ONKA-0912	MRK - 4 mm ² SLIM SERİ	4 mm ²	750V	32 A	3,21	ONKA-0872	4,72	100
ONKA-1132	MRK - 16 mm ² SLIM SERİ	16 mm ²	750V	76 A	11,66	ONKA-0882	13,53	50
ONKA-1142	MRK - 35 mm ² SLIM SERİ	35 mm ²	750V	125 A	16,43	ONKA-0892	18,60	30

MONTAJ RAYI ʈEŞİTLERİ

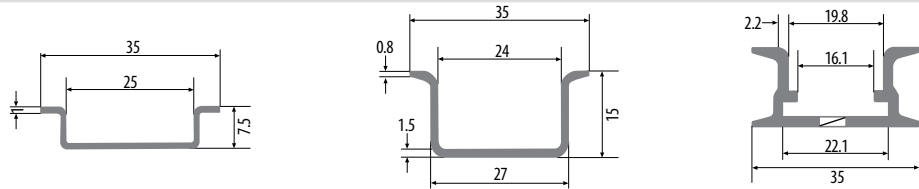

MRK RAY KLEMENS RENK KODLARI



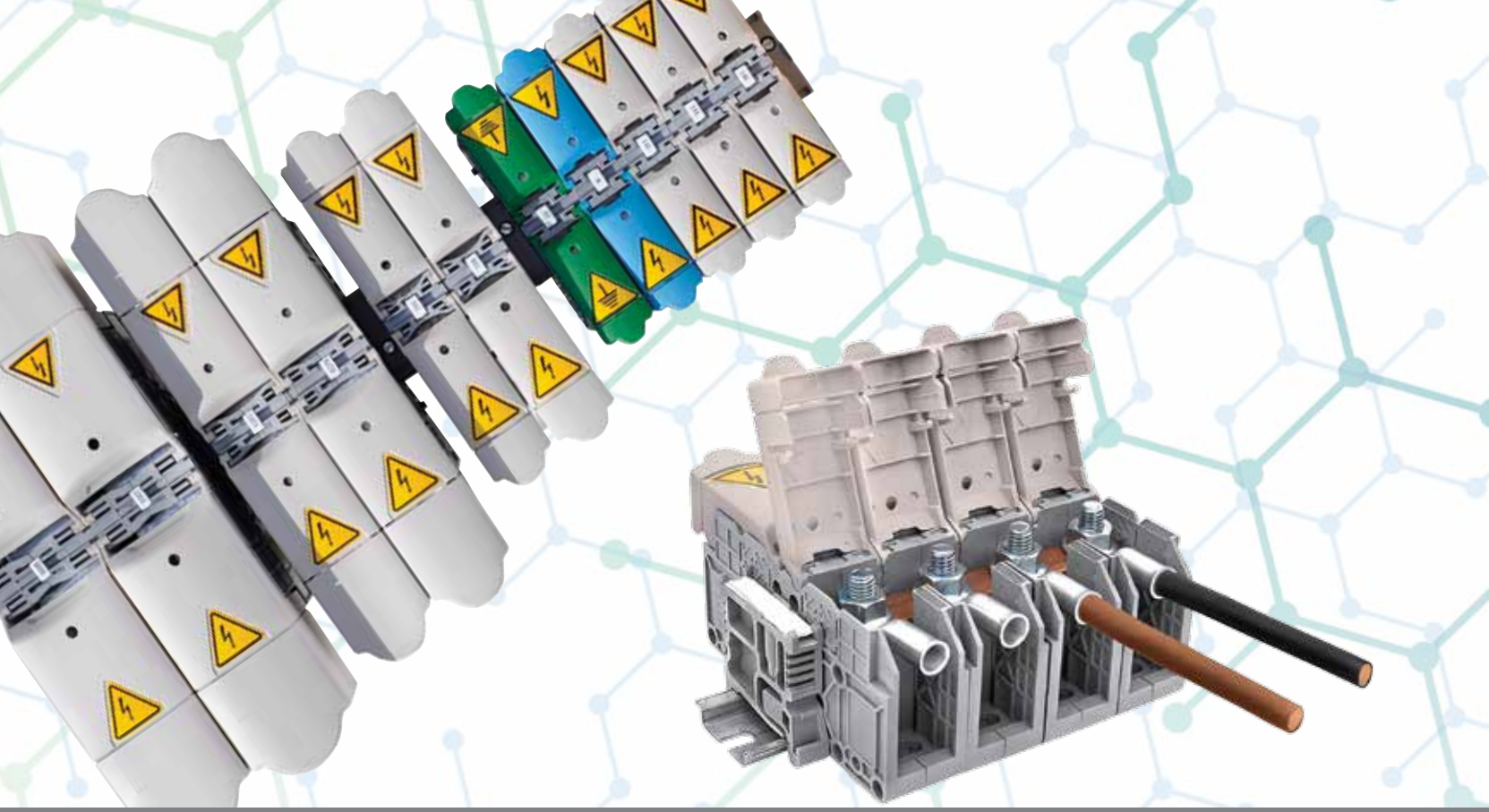

MRK SERİSİ PAPUÇ BAĞLANTILI BARALI RAY KLEMENSLER (KAPAKLI)

KOD	CİNSİ	AKIM (A)	AD. / ʘ	K. ADEDİ
ONKA-2302	25 mm ² Papuç Bağlantılı, Baralı, Kapaklı	100A	51,84	10/140
ONKA-2322	35 mm ² Papuç Bağlantılı, Baralı, Kapaklı	125A	53,70	10/140
ONKA-2342	50 mm ² Papuç Bağlantılı, Baralı, Kapaklı	150A	56,77	10/140
ONKA-2362	70 mm ² Papuç Bağlantılı, Baralı, Kapaklı	192A	74,38	10/80
ONKA-2382	95 mm ² Papuç Bağlantılı, Baralı, Kapaklı	232A	80,22	10/80
ONKA-2402	120 mm ² Papuç Bağlantılı, Baralı, Kapaklı	269A	145,57	5/30
ONKA-2422	150 mm ² Papuç Bağlantılı, Baralı, Kapaklı	309A	162,03	5/30
ONKA-2442	185 mm ² Papuç Bağlantılı, Baralı, Kapaklı	353A	183,78	5/20
ONKA-2462	240 mm ² Papuç Bağlantılı, Baralı, Kapaklı	415A	219,79	5/20

MRK SERİSİ PAPUÇ BAĞLANTILI BARALI RAY KLEMENSLER İÇİN ÜÇGEN ETİKET

KOD	CİNSİ	RENK	AD. / ʘ	PLAKA AD.
ONKA-2473	25 mm Üçgen Etiket	SARI	???	132



MONTAJ RAYI ÇEŞİTLERİ

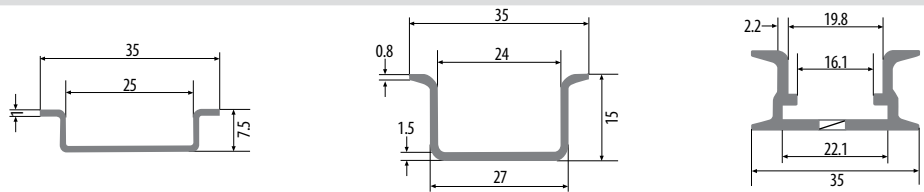

MRK RAY KLEMENS KAPAK RENK KODLARI



MRK SERİSİ ÇİFT KATLI (DOUBLE) RAY KLEMENSLER



11 mm PVC Şerit Etiket



KOD	CİNSİ	KABLO KESİTİ	GERİLİM (V)	AKIM (A)	AD. / ʘ	KOD (V0)	AD. / ʘ	K. AD.
ONKA-1612	MRK-D 2,5 mm ²	2,5 mm ²	750 V	24 A	8,37	ONKA-0732	9,79	50
ONKA-1622	MRK-D 2,5 mm ² İçten Köprülü	2,5 mm ²	750 V	24 A	15,40	ONKA-0482	17,40	50
ONKA-1632	MRK-D 2,5 mm ² Çift Katlı Diyotlu (Diyot yönü belirtiniz.)	2,5 mm ²	750 V	1 A	30,73	ONKA-??	ʘ	50
ONKA-1652	MRK-D 4 mm ²	4 mm ²	750 V	32 A	9,33	ONKA-0722	10,84	50
ONKA-1662	MRK-D 4 mm ² İçten Köprülü	4 mm ²	750 V	32 A	16,76	ONKA-0492	18,87	50
ONKA-1672	MRK-D 4 mm ² Çift Katlı Diyotlu (Diyot yönü belirtiniz.)	4 mm ²	750 V	1 A	32,08	ONKA-?	ʘ	50

MRK-S SERİSİ SİGORTALI RAY KLEMENSLER BARALI ve LEDLİ



KOD	CİNSİ	KABLO KESİTİ	GERİLİM (V)	AKIM (A)	AD. / ʘ	K. ADEDİ
ONKA-1322	MRK-S 6 mm ²	6 mm ²	750V	6.3 A	18,97	100
ONKA-1332	MRK-S 6 mm ²	6 mm ²	Baralı	6.3 A	20,71	100
ONKA-1342	MRK-S 6 mm ²	6 mm ²	12 V AC/ DC LED	6.3 A	35,99	100
ONKA-1352	MRK-S 6 mm ²	6 mm ²	24 V AC/ DC LED	6.3 A	35,99	100
ONKA-1372	MRK-S 6 mm ²	6 mm ²	48 V AC/DC LED	6.3 A	35,99	100
ONKA-1392	MRK-S 6 mm ²	6 mm ²	110 V AC/DC LED	6.3 A	35,99	100
ONKA-1402	MRK-S 6 mm ²	6 mm ²	220 V AC/DC LED	6.3 A	35,99	100

CAM SİGORTA



KOD	CİNSİ	AD. / ʘ	K. / AD.
WE-FS-52	5x20 mm Cam Sigorta (0.2.....10A Sigorta AKIMini Belirtiniz)	ʘ	100

MRK SERİSİ EK ALMA KLEMENSİ

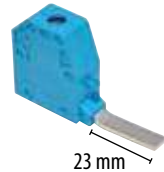
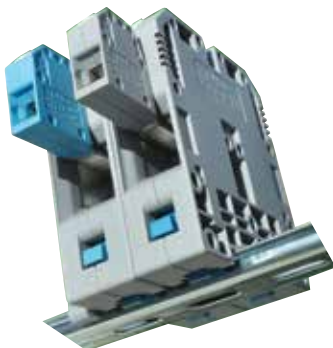

KOD	CİNSİ	AD. / ʘ	K. AD.
ONKA-1162	Maksimum 16 mm ² Köprü Boyu 18 mm 35-50 mm Klemens	10,23	100
ONKA-1172	Maksimum 16 mm ² Köprü Boyu 23 mm 70-95-120 mm Klemens	10,81	100

MRK TEST KLEMENS 6 mm² (Bıçaklı Kapalı Sistem)



KOD	CİNSİ	AD. / ʘ	K. AD.
ONKA-1316	Bıçaklı Sistem	17,63	100

MRK ÖLÇME & AYIRMA KLEMENSİ 6 mm²

KOD	CİNSİ	AD. / ʘ	K. AD.
ONKA-1285	Kovansız	21,45	50
ONKA-1281	Tek Test Kovanlı	24,63	50
ONKA-1283	Çift Test Kovanlı	27,82	50

MRK ÖLÇME & AYIRMA KLEMENSİ 6 mm² 4'LÜ SET



KOD	CİNSİ	AD. / ʘ	K. AD.
ONKA-1299	4'lü Set Çift Kovanlı 4'lü Set Köprülü Test Kovanlı	ʘ	ʘ

MRK ÖLÇME & AYIRMA KLM. 6 mm² AKSESUARLARI

Standart üstköprü



KOD	CİNSİ	AD. / ʘ	K. AD.
ONKA-1935	6 mm ² / 2 Kutup	3,88	100
ONKA-1936	6 mm ² / 3 Kutup	5,09	50
ONKA-1937	6 mm ² / 4 Kutup	6,48	50
ONKA-1938	6 mm ² / 10 Kutup	14,42	15
ONKA-1939	6 mm ² / 20 Kutup	26,08	10

MRK ÖLÇME & AYIRMA KLM. 6 mm² AKSESUARLARI

Çatal tip üstköprü



KOD	CİNSİ	AD. / ʘ	K. AD.
ONKA-1970	6 mm ² / 2 Kutup	2,83	10
ONKA-1971	6 mm ² / 3 Kutup	3,69	10
ONKA-1972	6 mm ² / 4 Kutup	4,83	10
ONKA-1973	6 mm ² / 6 Kutup	6,56	10
ONKA-1974	6 mm ² / 10 Kutup	10,34	10

Test Propu



KOD	CİNSİ	AD. / ʘ	K. AD.
ONKA-1280	Test Propu	???	10

MRK ÖLÇME & AYIRMA KLEMENSİ 10 mm²

KOD	CİNSİ	AD. / ʘ	K. AD.
ONKA-1310	Kovansız	24,46	75
ONKA-1311	Tek Kovanlı	30,84	75
ONKA-1312	Çift Kovanlı	30,75	75
ONKA-1306	Tek Test Kovanlı	32,76	75
ONKA-1308	Çift Test Kovanlı	41,06	75

MRK ÖLÇME & AYIRMA KLEMENSİ 10 mm² 4'LÜ SET



KOD	CİNSİ	AD. / ʘ	K. AD.
ONKA-1305	4'lü Set Çift Kovanlı 4'lü Set Köprülü Test Kovanlı	ʘ	ʘ

MRK ÖLÇME & AYIRMA KLM. 10 mm² AKSESUARLARI

KOD	CİNSİ	AD. / ʘ	K. AD.
ONKA-1303	2'li Üst Köprü	3,12	100
ONKA-1318	4'lü Üst Köprü	4,62	50
ONKA-1302	8'li Üst Köprü	7,60	50
ONKA-1319	Test Propu	8,08	50
ONKA-1304	Üst Köprü Kovanı	5,47	50

MRK SERİSİ TOPRAKLAMA KLEMENSLERİ



KOD	CİNSİ	AD. / ʘ	K. AD.
ONKA-1291	MTK 2,5 mm ²	10,67	100

MRK SERİSİ TOPRAKLAMA KLEMENSLERİ



KOD	CİNSİ	AD. / ʘ	K. AD.
ONKA-1293	MTK 4 mm ²	10,85	100

MRK SERİSİ TOPRAKLAMA KLEMENSLERİ

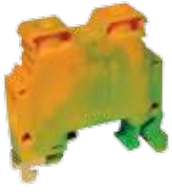

KOD	CİNSİ	AD. / ʘ	K. AD.
ONKA-1294	MTK 10 mm ²	15,57	100

MRK SERİSİ TOPRAKLAMA KLEMENSLERİ

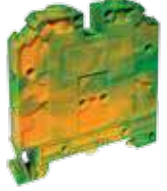

KOD	CİNSİ	AD. / ʘ	K. AD.
ONKA-1295	MTK 16 mm ²	43,39	50

MRK SERİSİ TOPRAKLAMA KLEMENSLERİ



KOD	CİNSİ	AD. / ʘ	K. AD.
ONKA-1296	MTK 35 mm ²	47,85	30

MÜHÜRLENEBİLİR KORUMA KAPAĞI



KOD	CİNSİ	AD. / ʘ	K. AD.
ONKA-1845	Kapak Profili (Şeffaf) mt.	ʘ	1
ONKA-1846	Kapak Profili (Renkli) mt.	ʘ	1
ONKA-1847	Yan Destek Parçası	ʘ	1
ONKA-1848	Mühürleme Aparatı	ʘ	1

MRK VE OPK SERİSİ DURDURUCU KÜÇÜK BOY



KOD	CİNSİ	AD. / ʘ	K. AD.
ONKA-1222	Küçük Durdurucu	1,87	100

MRK VE OPK SERİSİ VİDASIZ DURDURUCU



KOD	CİNSİ	AD. / ʘ	K. AD.
ONKA-1202	Vidasız Durdurucu	3,02	100

ÜSTTEN GEÇMELİ GRUP ETİKETİ



KOD	CİNSİ	AD. / ʘ	K. AD.
ONKA-1482	Üstten Geçmeli Grup Etiketi	0,87	100

MRK VE OPK SERİSİ DURDURUCU BÜYÜK BOY



KOD	CİNSİ	AD. / ʘ	K. AD.
ONKA-1212	Büyük Durdurucu	3,67	100

MRK VE OPK SERİSİ GRUP ETİKETLİ DURDURUCU



KOD	CİNSİ	AD. / ʘ	K. AD.
ONKA-1232	Grup Etiketli	3,75	100

MRK SERİSİ AYIRMA PLAKASI



KOD	CİNSİ	AD. / ʘ	K. AD.
ONKA-0582	Ayırma Plakası	2,81	25

MRK RAY KLEMENS İŞARETLERİ VE ETİKET YUVASI



KOD	Cinsi	AD./t	K. AD.
ONKA-1287	MRK Ray Klemens Şimşek İşaretleme	0,27	1000
ONKA-1289	Ray Klemens 11-12mm Etiket Yuvası	0,125	1000
ONKA-8943-S11	11 mm x 2 x 20 m 40 Metre Duple Şerit Etiket	14 €	1

DEKAFİXLER (MRK ve OPK SERİSİ)



KOD	Cinsi	AD./t	K. AD.
ONKA-9540	OD5-5 Baskısız	0,159	500
ONKA-9541	OD5-5B Baskılı	0,207	500
ONKA-9770	OD10-6 Baskısız	0,239	300
ONKA-9771	OD10-6B Baskılı	0,321	300
ONKA-5443	OD10-5P Baskısız, Birleşik Kopan (1,5 mm ² klemens için)	0,18	880
ONKA-5444	OD10-5P Baskılı, Birleşik Kopan (1,5 mm ² klemens için)	0,40	880
ONKA-4440	OD10-6P Baskısız Birleşik Kopan (2,5 mm ² klemens için)	0,21	720
ONKA-4441	OD10-6P Baskılı Birleşik Kopan (2,5 mm ² klemens için)	0,43	720
ONKA-4442	OD10-6P Baskısız Tek Tek Kopan (2,5 mm ² klemens için)	0,21	720
ONKA-4443	OD10-6P Baskılı Tek Tek Kopan (2,5 mm ² klemens için)	0,43	720
ONKA-4390	OD10-6P Baskısız, Birleşik Kopan (4 mm ² klemens için)	0,23	640
ONKA-4391	OD10-6P Baskılı, Birleşik Kopan (4 mm ² klemens için)	0,45	640
ONKA-2630	OD10-8P Baskısız, Birleşik Kopan (6 - 10 mm ² ve üzeri klemens için)	0,27	560
ONKA-2631	OD10-8P Baskılı, Birleşik Kopan (6 - 10 mm ² ve üzeri klemens için)	0,49	560

MRK SERİSİ RAY KLEMENS ÜST KÖPRÜ (Geçmeli)



İzole gövdenin tek parça olması iletken baraya yüksek güvenlik sağlar.



Köprü üzerindeki form sayesinde tornavida ile demonte edilebilir.



Köprü üzerindeki kesme kanalları sayesinde pin aralığının merkezinden kesim imkanı sağlar.
* Bu özellik 10 Pinli ve 20 Pinli üst köprüler için geçerlidir.

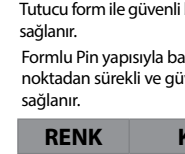

Tutucu form ile güvenli bağlantı sağlanır.
Formlu Pin yapıyla baraya dört noktadan sürekli ve güvenli temas sağlanır.

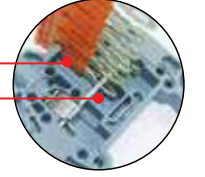

RENK	KOD	Cinsi	AD./t	K. AD.
Orange	ONKA-1920	1.5 x 2	2,74	100
Orange	ONKA-1921	1.5 x 3	3,46	100
Orange	ONKA-1922	1.5 x 4	4,25	100
Orange	ONKA-1923	1.5 x 10	8,72	30
Orange	ONKA-1924	1.5 x 20	15,12	20
Orange	ONKA-1920	2.5 x 2	2,74	100
Orange	ONKA-1921	2.5 x 3	3,46	100
Orange	ONKA-1922	2.5 x 4	4,25	75
Orange	ONKA-1923	2.5 x 10	8,72	30
Orange	ONKA-1924	2.5 x 20	15,12	20
Orange	ONKA-1925	2.5 x 2	2,88	100
Orange	ONKA-1926	2.5 x 3	3,91	100
Orange	ONKA-1927	2.5 x 4	4,39	75
Orange	ONKA-1928	2.5 x 10	9,52	30
Orange	ONKA-1929	2.5 x 20	17,19	20
Orange	ONKA-1925	4 x 2	2,88	100
Orange	ONKA-1926	4 x 3	3,91	50
Orange	ONKA-1927	4 x 4	4,39	50
Orange	ONKA-1928	4 x 10	9,52	30
Orange	ONKA-1929	4 x 20	17,19	20
Orange	ONKA-1930	4 x 2	3,11	100
Orange	ONKA-1931	4 x 3	4,47	100
Orange	ONKA-1932	4 x 4	4,90	50
Orange	ONKA-1933	4 x 10	10,61	30
Orange	ONKA-1934	4 x 20	18,53	20
Orange	ONKA-1935	6 x 2	3,88	100
Orange	ONKA-1936	6 x 3	5,09	50
Orange	ONKA-1937	6 x 4	6,48	50
Orange	ONKA-1938	6 x 10	14,42	15
Orange	ONKA-1939	6 x 20	26,08	10
Orange	ONKA-1940	10 x 2	4,25	100
Orange	ONKA-1941	10 x 3	5,63	50
Orange	ONKA-1942	10 x 4	6,96	50
Orange	ONKA-1943	10 x 10	15,38	15
Orange	ONKA-1944	10 x 20	30,87	10

"Slim seri üst köprüler sadece 0902 ve 0912 kodlu slim klemensler için kullanılmaktadır."

MRK SERİSİ RAY KLEMENS ÜST KÖPRÜ (Vidalı)



16 mm², 35 mm² vidalı üst köprüler mevcuttur.

11 mm PVC Şerit Etiket Takılabilir.

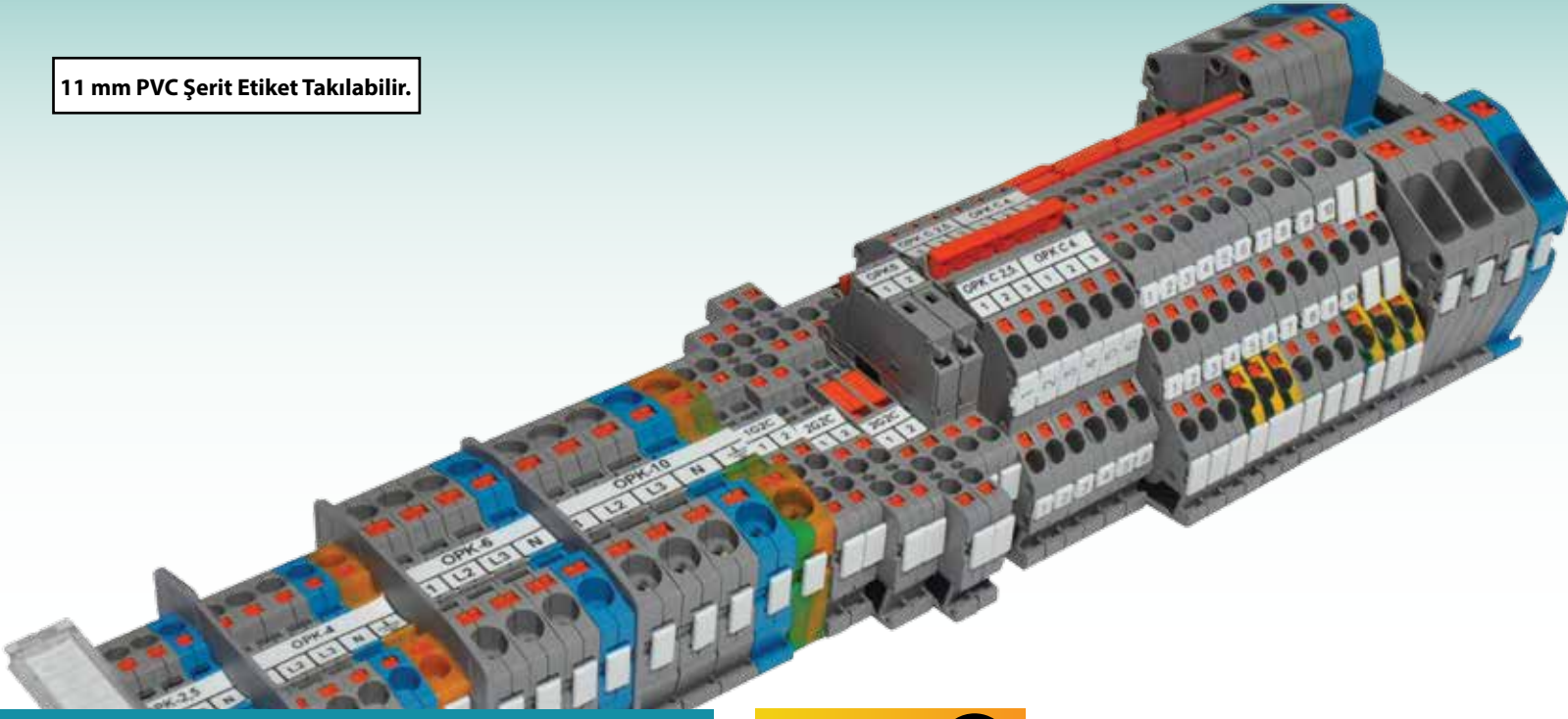

OPK SERİSİ

PUSH IN

Yay Baskılı Ray Klemensler

- Push-in Sistem.
- Nihayet plakası gerektirmez. (Her iki tarafı kapalı)
- Daha iyi bir izolasyon ve maliyet avantajı sağlar.
- 1 Katlılar simetriklerdir. (Her iki yönde raya monte edilebilir)
- Daha düşük kablo itme kuvvetiyle kolay montaj.
- Zaman ve maliyet tasarrufu.
- Yalıtkan butonlar sayesinde montaj esnasında iletken kısma sıfır temas.
- Paslanmaz çelik itici yaylar.
- 0,50 mm² den 35 mm² ye kadar yüksüklü kablolarda el aleti gerektirmeden montaj imkanı.
- Markalama yapısı evrensel olarak tüm markalama ekipmanlarına uygun tasarlanmıştır.
- Şerit etiketlemeye de uygun markalama yapısı.
- Çift yönlü köprüleme imkanı.
- İzoleli tarak köprü.
- Slim serilerle ergonomik ve kompakt tasarımlara imkan sağlayarak montaj alanını minimize eder.



• 2,5 - 4 - 6 - 10 mm² yay baskılı push-in klemenslerde şerit markalama sistemi uygulanabilir.



• OPK Serisi sigortalı klemenslerde yedek cam sigorta yuvası bulunmaktadır.



• Çift giriş - çift çıkış, tek giriş - çift çıkış, çift giriş - çift çıkış bıçaklı ayırma test klemenslerinde şerit markalama sistemi uygulanabilir.

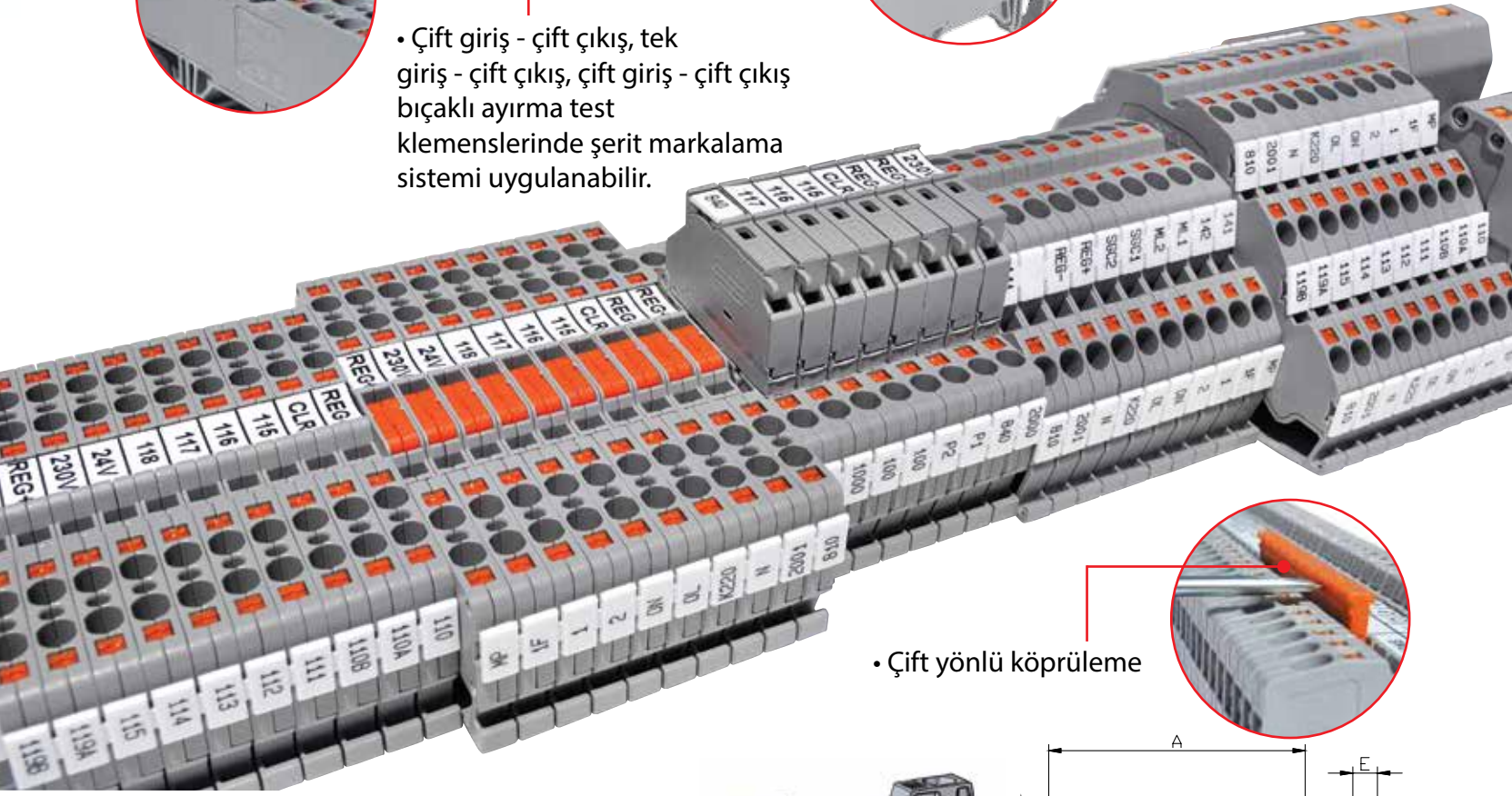
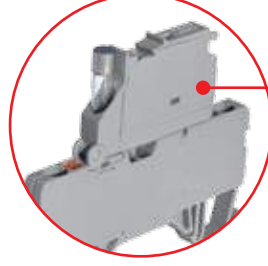

• Çift yönlü köprüleme

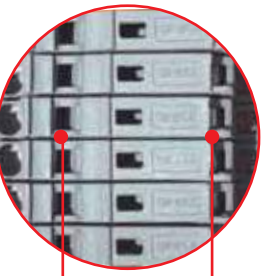

• OPK sigortalı klemenslerde sigortanın her iki kutbu önünde bulunan ölçüm noktaları sayesinde devreyi açmadan ve sigortayı çıkartmadan muayene ve kontrol yapılabilir.

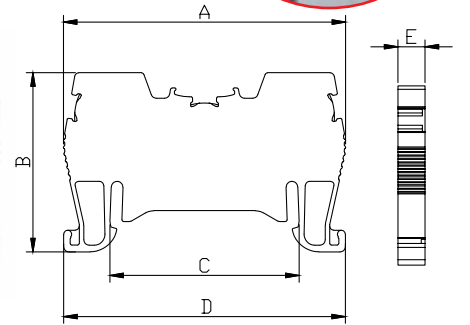
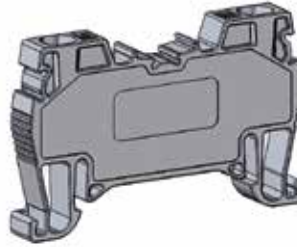

OPK 1,5

Ürün Kodu : 1592

Ölçüler (mm)	A	B	C	D	E
	52,0	33,0	34,5	51,9	5,0

OPK 2,5

Ürün Kodu : 0572

Ölçüler (mm)	A	B	C	D	E
	52,0	33,0	34,5	51,9	5,8

OPK 4

Ürün Kodu : 0562

Ölçüler (mm)	A	B	C	D	E
	52,0	33,0	34,5	51,9	6,6

• Slim seri ergonomik ve kompakt tasarımlara imkan sağlayarak montaj alanını minimize eder.





PUSH IN

16 mm² ve 35 mm²'lik Kesitlerde
Çift Yay Baskılı Sistem.

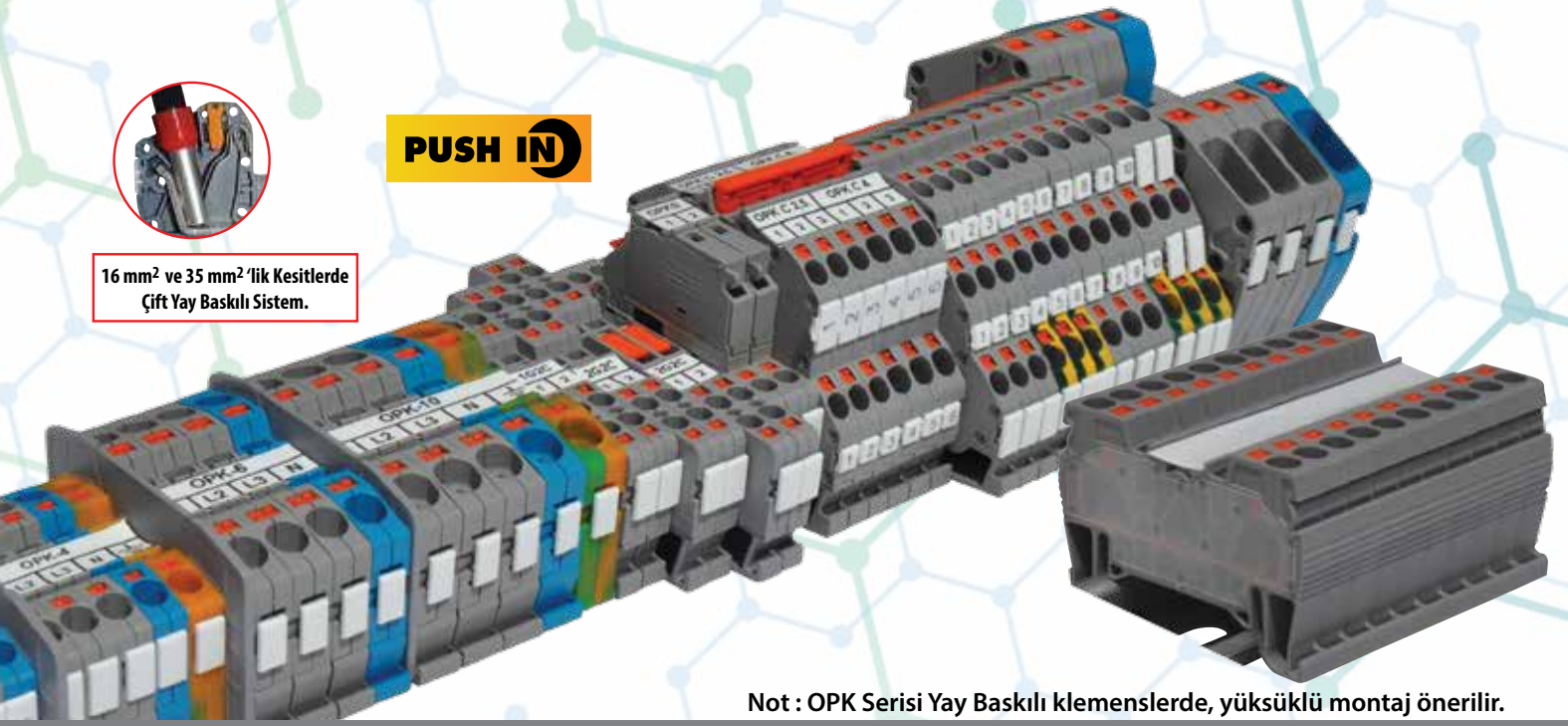

Not : OPK Serisi Yay Baskılı klemenslerde, yüksüklü montaj önerilir.

OPK SERİSİ YAY BASKILI RAY KLEMENSLER (PUSH-IN SİSTEM HER İKİ TARFI KAPALI)

KOD	CİNSİ	KABLO KESİTİ	GERİLİM (V)	AKIM (A)	AD. / 7	KOD (V0)	AD. / 7	K. AD.
ONKA-1592	OPK - 1,5 mm ²	1,5 mm ²	750 V	17,5 A	???	ONKA-0532	?????	100
ONKA-1502	OPK - 2,5 mm ²	2,5 mm ²	750 V	24 A	2,90	ONKA-0922	3,42	100
ONKA-1512	OPK - 4 mm ²	4 mm ²	750 V	32 A	3,07	ONKA-0932	3,68	100
ONKA-1522	OPK - 6 mm ²	6 mm ²	750 V	41 A	7,65	ONKA-0942	8,74	100
ONKA-1532	OPK - 10 mm ²	10 mm ²	750 V	57 A	8,17	ONKA-0952	9,50	100
ONKA-1542	OPK - 16 mm ² Çift Yay Baskılı Sistem	16 mm ²	750 V	76 A	26,18	ONKA-0962	31,28	30
ONKA-1552	OPK - 35 mm ² Çift Yay Baskılı Sistem	35 mm ²	750 V	125 A	32,98	ONKA-0972	37,52	20

OPK SLİM SERİSİ YAY BASKILI RAY KLEMENSLER (PUSH-IN SİSTEM HER İKİ TARFI KAPALI)

KOD	CİNSİ	KABLO KESİTİ	GERİLİM (V)	AKIM (A)	AD. / 7	KOD (V0)	AD. / 7	K. AD.
ONKA-0572	OPK - 2,5 mm ² SLİM SERİ	2,5 mm ²	750 V	24 A	???	ONKA-0542	??????	100
ONKA-0562	OPK - 4 mm ² SLİM SERİ	4 mm ²	750 V	32 A	??	ONKA-0552	??????	100

MONTAJ RAYI ÇEŞİTLERİ

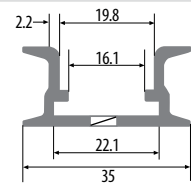
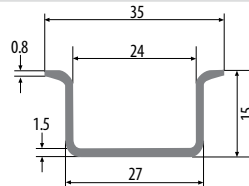
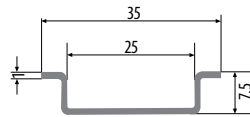

OPK RAY KLEMENS RENK KODLARI



OPK SERİSİ YAY BASKILI İKİ KATLI (DOUBLE) KLEMENSLER

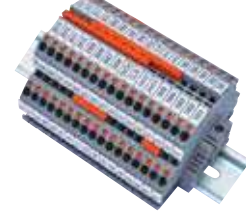

KOD	CİNSİ	KABLO KESİTİ	GERİLİM (V)	AKIM (A)	AD. / ʈ	KOD (V0)	AD. / ʈ	K. AD.
ONKA-1782	OPK - D 2,5 mm ²	2,5 mm ²	750 V	24 A	9,73	ONKA-0702	11,57	50
ONKA-2572	OPK - D 2,5 mm ² İçten Köprülü	2,5 mm ²	750 V	24 A	16,43	ONKA-0472	18,88	50
ONKA-2582	OPK - D 2,5 mm ² Diyotlu Yönlü	2,5 mm ²	750 V	24 A	35,28	ONKA-0462	37,74	50
ONKA-1792	OPK - D 4 mm ²	4 mm ²	750 V	32 A	10,05	ONKA-0692	12,06	50
ONKA-2592	OPK - D 4 mm ² İçten Köprülü	4 mm ²	750 V	32 A	16,78	ONKA-0452	19,46	50
ONKA-2602	OPK - D 4 mm ² Diyotlu Yönlü	4 mm ²	750 V	32 A	35,64	ONKA-0442	38,31	50

OPK SERİSİ YAY BASKILI ÜÇ KATLI (TRIPLE) KLEMENSLER



KOD	CİNSİ	KABLO KESİTİ	GERİLİM (V)	AKIM (A)	AD. / ʈ	KOD (V0)	AD. / ʈ	K. AD.
ONKA-1852	OPK - T 2,5 mm ²	2,5 mm ²	750 V	24 A	13,80	ONKA-0682	16,06	50
ONKA-1862	OPK - T 2,5 mm ² İçten Köprülü	2,5 mm ²	750 V	24 A	15,17	ONKA-0432	26,51	50
ONKA-1872	OPK - T 2,5 mm ² Topraklı	2,5 mm ²	750 V	24 A	2958	ONKA-0672	32,59	50
ONKA-1882	OPK - 3 4 mm ²	4 mm ²	750 V	32 A	31,36	ONKA-0683	17,66	50
ONKA-1892	OPK - T 4 mm ² İçten Köprülü	4 mm ²	750 V	32 A	23,50	ONKA-0422	28,52	50
ONKA-1902	OPK - T 4 mm ² Topraklı	4 mm ²	750 V	32 A	25,17	ONKA-0412	34,70	50

OPK SERİSİ YAY BASKILI SİĞORTALI RAY KLEMENS

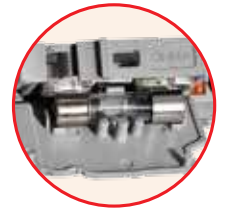
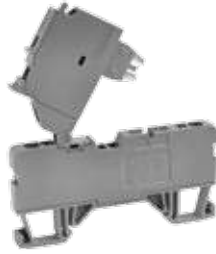

KOD	CİNSİ	KABLO KESİTİ	GERİLİM (V)	AKIM (A)	AD. / ʈ	K. / AD.
ONKA-2482	OPK-S 2.5 mm ²	2.5 mm ²	Boş	6.3 A	11,96	50
ONKA-2492	OPK-S 2.5 mm ²	2.5 mm ²	Baralı	6.3 A	13,15	50
ONKA-2502	OPK-S 2.5 mm ²	2.5 mm ²	12 V AC/DC LED	6.3 A	18,93	50
ONKA-2512	OPK-S 2.5 mm ²	2.5 mm ²	24 V AC/DC LED	6.3 A	18,93	50
ONKA-2532	OPK-S 2.5 mm ²	2.5 mm ²	48 V AC/DC LED	6.3 A	18,93	50
ONKA-2552	OPK-S 2.5 mm ²	2.5 mm ²	110 V AC/DC LED	6.3 A	18,93	50
ONKA-2562	OPK-S 2.5 mm ²	2.5 mm ²	220 V AC/DC LED	6.3 A	18,93	50

OPK RAY KLEMENS RENK KODLARI



OPK SERİSİ BİR GİRİŞ İKİ ÇIKIŞ RAY KLEMENS



KOD	CİNSİ	KABLO KESİTİ	GERİLİM (V)	AKIM (A)	AD. / ʈ	KOD (VO)	AD. / ʈ	K. AD.
ONKA-1262	OPK 2,5 mm ² Klemensi 1 Giriş - 2 Çıkış	2,5 mm ²	750 V	24 A	6,43	ONKA-0662	7,39	50

OPK SERİSİ İKİ GİRİŞ İKİ ÇIKIŞ RAY KLEMENS



KOD	CİNSİ	KABLO KESİTİ	GERİLİM (V)	AKIM (A)	AD. / ʈ	KOD (VO)	AD. / ʈ	K. AD.
ONKA-1252	OPK 2,5 mm ² Klemensi 2 Giriş - 2 Çıkış	2,5 mm ²	750 V	24 A	7,57	ONKA-0652	8,74	50

OPK SERİSİ YAY BASKILI TEST KLEMENSİ (2 GİRİŞ / 2 ÇIKIŞ)

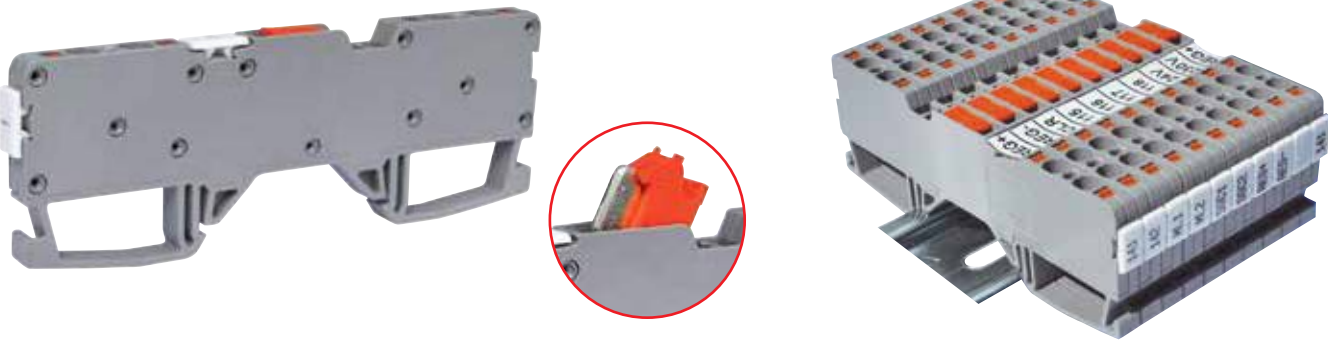

KOD	CİNSİ	KABLO KESİTİ	GERİLİM (V)	AKIM (A)	AD. / ʈ	KOD (VO)	AD. / ʈ	K. AD.
ONKA-1242	OPK 2,5 mm ² Test Klemensi 2 Giriş - 2 Çıkış	2,5 mm ²	750 V	24 A	10,92	ONKA-0642	12,21	50

OPK RAY KLEMENS RENK KODLARI



OPK SERİSİ YAY BASKILI TOPRAKLAMA KLEMENSLERİ



KOD	CİNSİ	AD. / ʘ	K. AD.
ONKA-1199	OTK 4 mm ²	9,32	100

MRK VE OPK SERİSİ VİDASIZ DURDURUCU



KOD	CİNSİ	AD. / ʘ	K. AD.
ONKA-1202	Vidasız Durdurucu	3,02	100

OPK SERİSİ YAY BASKILI TOPRAKLAMA KLEMENSLERİ



KOD	CİNSİ	AD. / ʘ	K. AD.
ONKA-1200	OTK 10 mm ²	16,35	100

MRK VE OPK SERİSİ DURDURUCU KÜÇÜK BOY



KOD	CİNSİ	AD. / ʘ	K. AD.
ONKA-1222	Küçük Durdurucu	1,87	100

OPK SERİSİ AYIRMA PLAKASI



KOD	CİNSİ	AD. / ʘ	K. AD.
ONKA-0592	Ayırma Plakası	2,66	25

MRK VE OPK SERİSİ DURDURUCU BÜYÜK BOY



KOD	CİNSİ	AD. / ʘ	K. AD.
ONKA-1212	Büyük Durdurucu	3,67	100

ÜSTTEN GEÇMELİ GRUP ETİKETİ



KOD	CİNSİ	AD. / ʘ	K. AD.
ONKA-1482	Üstten Geçmeli Grup Etiketi	0,87	100

MRK VE OPK SERİSİ GRUP ETİKETLİ DURDURUCU



KOD	CİNSİ	AD. / ʘ	K. AD.
ONKA-1232	Grup Etiketli	3,75	100

MÜHÜRLENEBİLİR KORUMA KAPAĞI



KOD	CİNSİ	AD. / ʘ	K. AD.
ONKA-1845	Kapak Profili (Şeffaf) mt.	1	1
ONKA-1846	Kapak Profili (Renkli) mt.	1	1
ONKA-1847	Yan Destek Parçası	1	1
ONKA-1848	Mühürleme Aparatı	1	1

CAM SİGORTA



KOD	CİNSİ	AD. / ʘ	K. AD.
WE-FS-52	5x20 mm (0.2...10A Sigorta Akımını Belirtiniz)	1	100

OPK RAY KLEMENS RENK KODLARI



OPK RAY KLEMENS İŞARETLERİ VE ETİKET YUVASI



KOD	CİNSİ	AD./ ʘ	K. AD.
ONKA-1288	OPK Ray Klemens Şimşek İşaretlemesi	0,27	1000
ONKA-1289	Ray Klemens 11-12mm Etiket Yuvası	0,125	1000
ONKA-8943-S11	11 mm x 2 x 20 m 40 Metre Duble Şerit Etiket	14 €	20 m x 1

DEKAFİXLER (MRK ve OPK SERİSİ)

KOD	CİNSİ	AD./ ʘ	K. AD.
ONKA-9540	OD5-5 Baskısız	0,159	500
ONKA-9541	OD5-5B Baskılı	0,207	500
ONKA-9770	OD10-6 Baskısız	0,239	300
ONKA-9771	OD10-6B Baskılı	0,321	300
ONKA-5443	OD10-5P Baskısız, Birleşik Kopan (1,5 mm ² klemens için)	0,18	880
ONKA-5444	OD10-5P Baskılı, Birleşik Kopan (1,5 mm ² klemens için)	0,40	880
ONKA-4440	OD10-6P Baskısız Birleşik Kopan (2,5 mm ² klemens için)	0,21	720
ONKA-4441	OD10-6P Baskılı Birleşik Kopan (2,5 mm ² klemens için)	0,43	720
ONKA-4442	OD10-6P Baskısız Tek Tek Kopan (2,5 mm ² klemens için)	0,21	720
ONKA-4443	OD10-6P Baskılı Tek Tek Kopan (2,5 mm ² klemens için)	0,43	720
ONKA-4390	OD10-6P Baskısız, Birleşik Kopan (4 mm ² klemens için)	0,23	640
ONKA-4391	OD10-6P Baskılı, Birleşik Kopan (4 mm ² klemens için)	0,45	640
ONKA-2630	OD10-8P Baskısız, Birleşik Kopan (6 - 10 mm ² ve üzeri klemens için)	0,27	560
ONKA-2631	OD10-8P Baskılı, Birleşik Kopan (6 - 10 mm ² ve üzeri klemens için)	0,49	560

OPK SERİSİ RAY KLEMENS ÜST KÖPRÜ (Geçmeli)



RENK	KOD	CİNSİ	AD./ʘ	K. AD.
Orange	ONKA-1920	1.5 x 2	2,74	100
Orange	ONKA-1921	1.5 x 3	3,46	100
Orange	ONKA-1922	1.5 x 4	4,25	100
Orange	ONKA-1923	1.5 x 10	8,72	30
Orange	ONKA-1924	1.5 x 20	15,12	20
Orange	ONKA-1920	2.5 x 2	2,74	100
Orange	ONKA-1921	2.5 x 3	3,46	100
Orange	ONKA-1922	2.5 x 4	4,25	75
Orange	ONKA-1923	2.5 x 10	8,72	30
Orange	ONKA-1924	2.5 x 20	15,12	20
Orange	ONKA-1925	2.5 x 2	2,88	100
Orange	ONKA-1926	2.5 x 3	3,91	100
Orange	ONKA-1927	2.5 x 4	4,39	75
Orange	ONKA-1928	2.5 x 10	9,52	30
Orange	ONKA-1929	2.5 x 20	17,19	20
Orange	ONKA-1925	4 x 2	2,88	100
Orange	ONKA-1926	4 x 3	3,91	50
Orange	ONKA-1927	4 x 4	4,39	50
Orange	ONKA-1928	4 x 10	9,52	30
Orange	ONKA-1929	4 x 20	17,19	20
Orange	ONKA-1930	4 x 2	3,11	100
Orange	ONKA-1931	4 x 3	4,47	100
Orange	ONKA-1932	4 x 4	4,90	50
Orange	ONKA-1933	4 x 10	10,61	30
Orange	ONKA-1934	4 x 20	18,53	20
Red	ONKA-1945	6 x 2	3,51	100
Red	ONKA-1946	6 x 3	4,24	50
Red	ONKA-1947	6 x 4	5,43	50
Red	ONKA-1948	6 x 10	11,99	15
Red	ONKA-1949	6 x 20	21,09	10
Red	ONKA-1950	10 x 2	3,60	100
Red	ONKA-1951	10 x 3	4,66	50
Red	ONKA-1952	10 x 4	5,91	50
Red	ONKA-1953	10 x 10	12,89	15
Red	ONKA-1954	10 x 20	24,49	10
Red	ONKA-1955	16 x 2	4,47	10
Red	ONKA-1956	16 x 3	6,34	10
Red	ONKA-1957	16 x 4	8,97	10
Red	ONKA-1958	16 x 10	17,74	10
Red	ONKA-1959	35 x 2	5,36	10
Red	ONKA-1960	35 x 3	7,62	10
Red	ONKA-1961	35 x 4	10,68	10
Red	ONKA-1962	35 x 10	21,99	10

"Slim seri üst köprüler sadece 0572 ve 0562 kodlu slim klemensler için kullanılmaktadır."

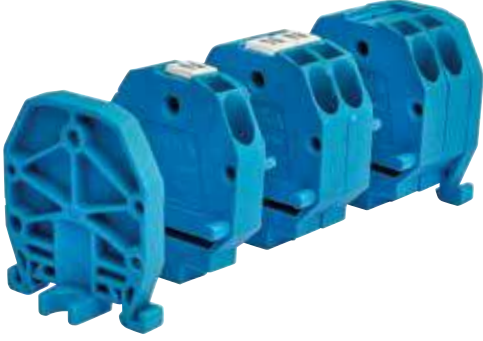
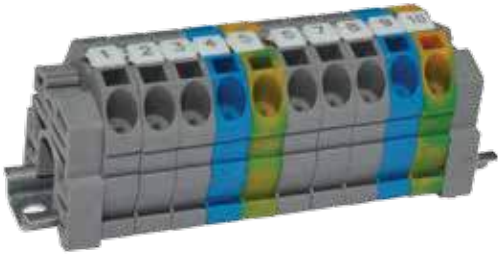

PUSH IN

MPK SERİSİ

Yay Baskılı Mini Ray Klemensler

MPK raya montaj mini yay baskılı klemensler birleştirilmiş yapısıyla kullanıcıya bir çok fayda sağlamaktadır. OPK klemens grubunun küçültülmüş versiyonu olarak dizayn edilmiştir. Mini yay baskılı klemensler, OPK serisi ile aynı özellikleri taşımaktadır. Yüksüklü ve yüksüksüz kabloların sadece ileri itilmesiyle başka herhangi bir alete ihtiyaç duyulmadan kolayca montaj imkanı sağlar.

Küçük kompakt yapısı sayesinde pano ve bağlantı kutuları içinde kullanıcıya alan kazandırarak ergonomik tasarımlara yararlı.

MPK Klemens serisi, 15 x 5,5 mm raya ve farklı sonlandırma plaka alternatifleriyle düz zemin üzerine monte edilebilir.

Mini Yay Baskılı Klemenslerin kontak kısmı bakır üzerine kalay kaplamadan oluşmaktadır. Paslanmaz çelik, krom ve nikel alaşımından üretilmiş yay, kablo üzerine baskı uygular. Su, Asit ve yüksek ısı içeren atmosfer koşullarına karşı yüksek dayanım göstererek okside olmaz. Mini yay baskılı klemenslerin sıkı yapısı, buatların içinde kullanıma olanak sağlar. Ürünün dışı, izoleli plastik gövdesi sayesinde, patlayıcıların ve gazların bulunduğu alanlarda da güvenle kullanımına olanak sağlar. MPK Klemens serisi bir çok renk alternatifine sahiptir.

Bu ürünün en dikkat çekici özelliklerinden biri de, numaralandırma içermesi ve 2'li, 3'lü, 4'lü ve talebe bağlı daha fazla modüllerde dizayn edilebilmesidir. Bütün terminallerin birbirine eş potansiyel köprülenebilme özelliği sayesinde, dağıtım ve dengeleme barası şeklinde kullanım imkanı da sağlarken düşük bağlantı empedanslı ideal buat uygulamaları yapılabilir. Bu ürün nötr dağıtım ve topraklama işlerinde yoğun olarak kullanılır. MPK klemens serisinin markalamasında piyasada yaygın olarak tercih edilen standart dekaflıklar kullanılmaktadır. Ürünün yay baskılı olması vibrasyonlu ortamlarda da güvenle kullanılmasına olanak sağlamaktadır.



MPK SERİSİ MİNİ YAY BASKILI KLEMENSLER (PUSH-IN HER İKİ TARAFI KAPALI SİSTEM)



KOD	CİNSİ	KABLO KESİTİ	GERİLİM (V)	AD. / ʘ	K. AD.
ONKA-1422	MPK - 2,5 mm ² 24 A	2,5 mm ²	750 V	2,47	100

MP SERİSİ MİNİ YAY BASKILI KLEMENSLER (PUSH-IN SİSTEM)



KOD	CİNSİ	KABLO KESİTİ	GERİLİM (V)	AD. / ʘ	K. AD.
ONKA-1462	MP - 2,5 mm ² 24 A	2,5 mm ²	750 V	2,84	100

MPK SERİSİ MİNİ YAY BASKILI TOPRAKLI KLEMENSLER (PUSH-IN HER İKİ TARAFI KAPALI SİSTEM)



KOD	CİNSİ	KABLO KESİTİ	GERİLİM (V)	AD. / ʘ	K. AD.
ONKA-1470	MPK - 2,5 mm ² 24 A	2,5 mm ²	750 V	2,94	100

MP SERİSİ MİNİ YAY BASKILI KLEMENSLER (İÇTEN KÖPRÜLÜ) X KLEMENS ADEDİ



KOD	CİNSİ	KABLO KESİTİ	GERİLİM (V)	AD. / ʘ	K. AD.
ONKA-1432	MPK - 2,5 mm ² 24 A	2,5 mm ²	750 V	ʘ	100

DEKAFİKLER



KOD	CİNSİ	AD. / ʘ	K. AD.
ONKA-9540	OD5-5 Baskısız	0,159	500
ONKA-9541	OD5-5B Baskılı	0,207	500

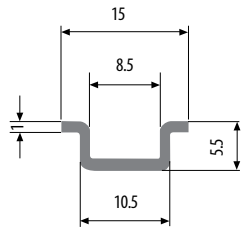

MONTAJA UYGUN RAY TİPLERİ

ONKA-4251
ONKA-4252
ONKA-4253
ONKA-4111
ONKA-4112
ONKA-4112

DURDURUCU VE SONLANDIRICILAR



KOD	CİNSİ	AD. / ʘ	K. AD.
ONKA-1442	Durdurucu ve Sonlandırıcı Raya takılabilir ve zemine vidalanabilir.	0,68	100



KOD	CİNSİ	AD. / ʘ	K. AD.
ONKA-1452	Durdurucu ve Sonlandırıcı Zemine geçmeli.	0,68	100



KOD	CİNSİ	AD. / ʘ	K. AD.
ONKA-1472	Durdurucu		100

MPK RAY KLEMENS RENK KODLARI





PROJE ve UYGULAMALARINIZA **ÖZEL ÇÖZÜMLER**

Onka[®]
elektriğin küçük devleri



www.onka.com.tr

PROJE VE UYGULAMALARINIZA ÖZEL ÇÖZÜMLER

YATIRIM VE UYGULAMA SÜREÇLERİNDE DÜŞÜK MALİYET.

STANDARTİZASYON SAYESİNDE KURULUM VE İŞLETME HATALARININ MİNİMİZE EDİLMESİ.

GENİŞ RENK SEÇENEĞİ VE MARKALAMA YAPISIYLA DAHA DOĞRU , DAHA HIZLI UYGULAMA.

DAHA DÜŞÜK BAĞLANTI EMPEDANSIYLA DAHA AZ KAYIP, DAHA YÜKSEK İŞLETME ÖMRÜ.

Gelişen teknoloji ile birlikte doğan özel ihtiyaçların karşılanmasına yönelik; kompakt, estetik, işletme ömrü boyunca tesisi yöneten teknik personelin binlerce düğüm noktası arasında sağlıklı ve kontrollü işlem yapabileceği, her açıdan sürdürülebilir kalite sağlayacak optimum bağlantı tasarımları sunuyoruz.

- YURLAR
- OKULLAR
- HASTANELER
- ARITMA TESİSLERİ
- SAVUNMA SANAYİİ
- BİLGİ İŞLEM MERKEZLERİ
- TRAFİK YÖNETİM SİSTEMLERİ
- ENERJİ ÜRETİM/İLETİM/DAĞITIM TESİSLERİ
- AKILLI BİNA OTOMASYONU VE HVAC SİSTEMLERİ
- MAKİNE , ASANSÖR , VİNÇ , EKİPMAN SERİ ÜRÜNLERİ

Standartizasyon gerektiren yapı ve sistemler için proje grubumuzla geliştirdiğimiz bağlantı çözümlerimiz ve hazır set tasarımlarımızla teknik ve ekonomik avantajlar sağlıyoruz. Bilgi ve teknik destek için satış/pazarlama birimlerimizle irtibata geçiniz.

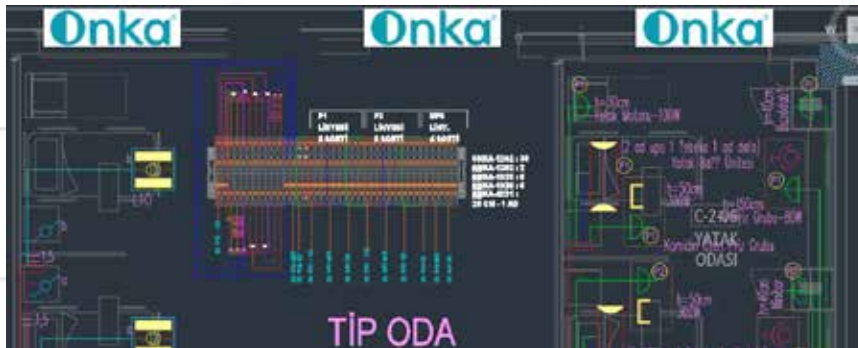

2KL-9/A1 - FAZ

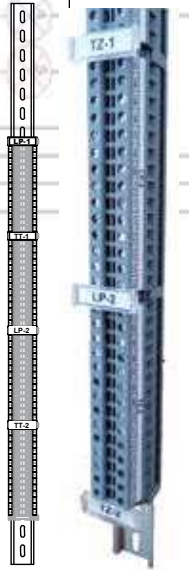
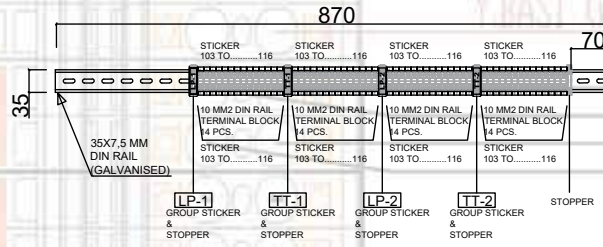
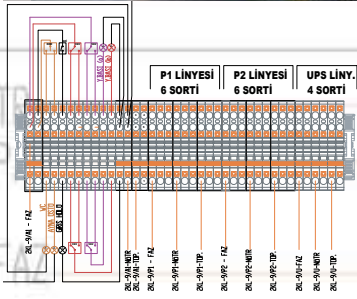
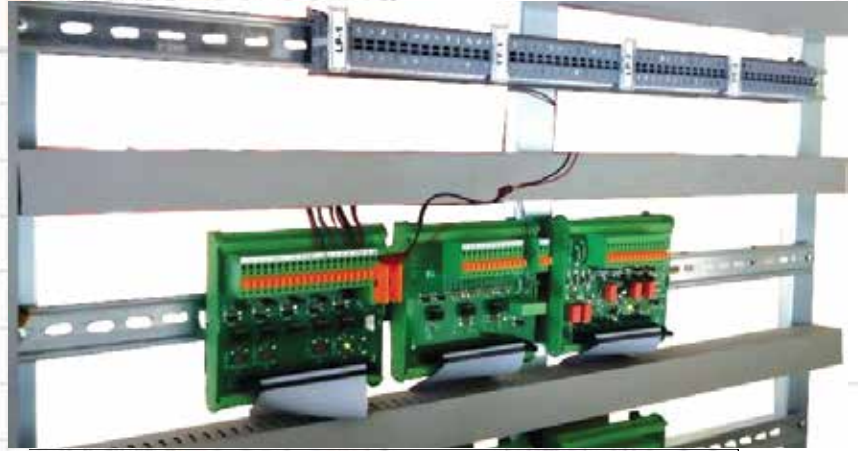

TIP-1 SET (GRI)
53mm

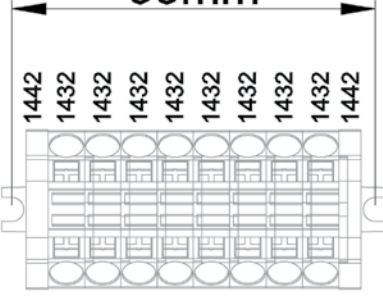

TIP-2 SET (MAVI)
53mm

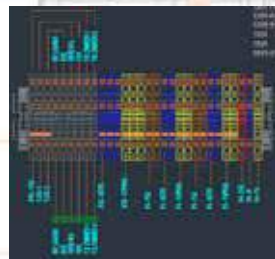
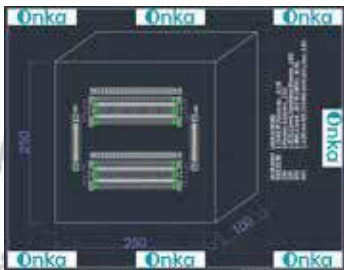
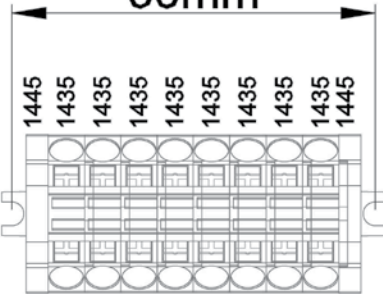

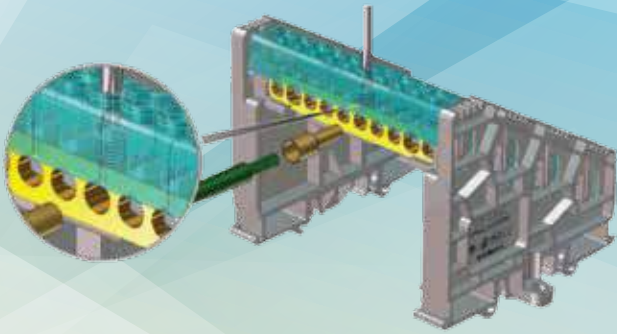
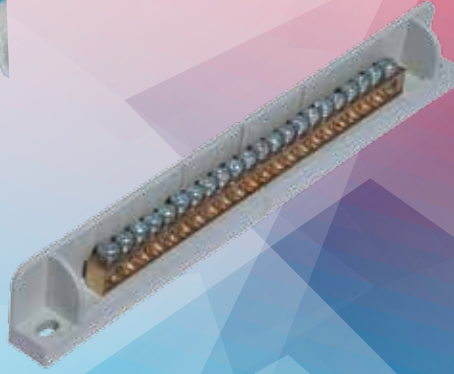
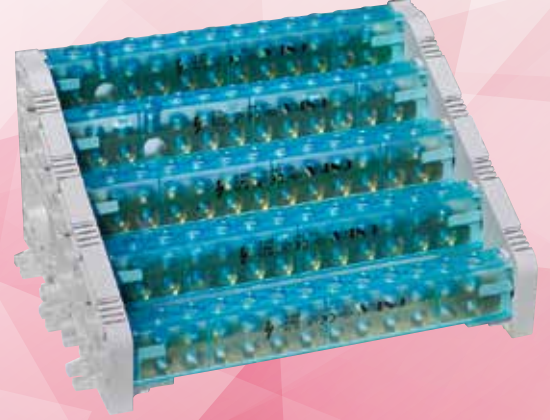
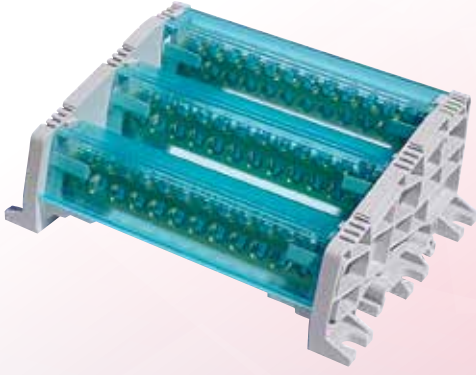

Pano ve bağlantı kutuları içinde ;

- Güvenli,
- Ergonomik
- Estetik bağlantılarla kayıpsız enerji dağıtım ve toplama.
- Yüksek kısadevre gücü ve dielektrik yapısı ile maksimum pano, tesis ve personel güvenliği.
- Yetkisiz personel ve canlılar için kazara dokunmalara karşı ekstra emniyet ve formlama kabiliyeti. (FORM-2 / FORM2-B)
- Yenilenebilir enerji sektörü AC/DC Toplama panoları için ideal kompakt çözüm, 1500V-DC işletme gerilimi altında sürekli çalışabilme imkanı.

DAĞITICI ÜNİTELER



TEK KUTUPLU İZOLASYONLU MODÜLER DAĞITICI ÜNİTE 80A (6,5x9 mm)

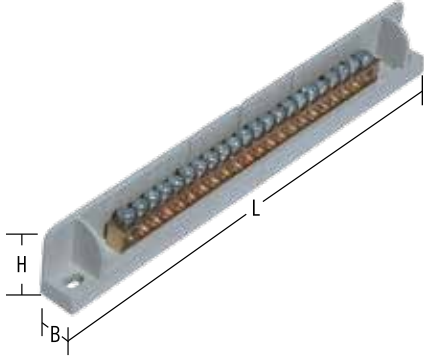

KOD	CİNSİ	L	B	H	AD. / ʘ	K. AD.
İRPTKG-10010	1x10 DELİK TEK KUTUP / 1x10 HOLE ONE POLE	128	115	25.65	11,22	100
İRPTKG-10011	1x11 DELİK TEK KUTUP / 1x11 HOLE ONE POLE	128	115	25.65	12,14	100
İRPTKG-10015	1x15 DELİK TEK KUTUP / 1x15 HOLE ONE POLE	128	115	25.65	15,36	100
İRPTKG-10020	1x20 DELİK TEK KUTUP / 1x20 HOLE ONE POLE	183	168	25.65	22,23	100
İRPTKG-10030	1x30 DELİK TEK KUTUP / 1x30 HOLE ONE POLE	225	213	25.65	32,57	100

İKİ KUTUPLU İZOLASYONLU MODÜLER DAĞITICI ÜNİTE 80A (6,5x9 mm)

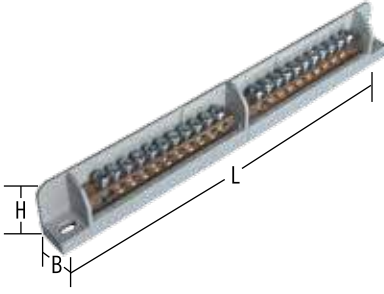

KOD	CİNSİ	L	B	H	AD. / ʘ	K. AD.
İRPTKG-20008	2x8 DELİK İKİ KUTUP / 2x8 HOLE TWO POLE	182	168	25.65	16,89	100
İRPTKG-20011	2x11 DELİK İKİ KUTUP / 2x11 HOLE TWO POLE	182	168	25.65	23,85	100
İRPTKG-20015	2x15 DELİK İKİ KUTUP / 2x15 HOLE TWO POLE	260	245	25.65	33,28	100

ÜÇ KUTUPLU İZOLASYONLU MODÜLER DAĞITICI ÜNİTE 80A (6,5x9 mm)

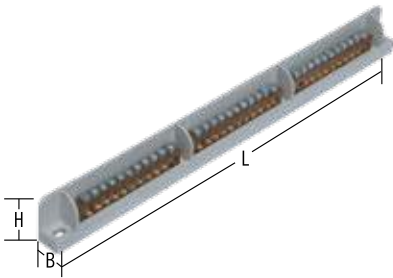

KOD	CİNSİ	L	B	H	AD. / ʘ	K. AD.
İRPTKG-30011	3x11 DELİK ÜÇ KUTUP / 3x11 HOLE THREE POLE	260	245	25.65	25,22	100

BAKIR BARA BAĞLANTI KLEMENSİ



YENİ

Modüler yapısı sayesinde birleştirilerek çoklu uygulamalar yapılabilir.

KOD	CİNSİ	L	B	H	AD. / ʘ	K. AD.
İRPKL-4010	4x1-TEKLİ BAĞLANTI KLEMENSİ / COPPER CONNECTION TERMINAL	120	20	19	ʘ	50
İRPKL-2020	2x1-İKİLİ BAĞLANTI KLEMENSİ / COPPER CONNECTION TERMINAL	120	20	19	ʘ	50

PANO TOPRAKLAMA KLEMENSLERİ (6.5 x 9 mm KESİT) 80 AMPER

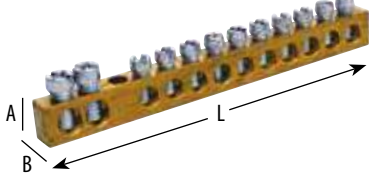

Çok Tellî Kablo kesiti max. 10 mm²
Tek Damarlı Kablo kesiti max. 16 mm²

KOD	CİNSİ	A	B	L±2	AD. / ʘ	K. AD.
ONKA - 2001	2/3 = 5 Delikli Pano Top. Klemensi	9	6,5	42	6,29	50
ONKA - 2002	2/5 = 7 Delikli Pano Top. Klemensi	9	6,5	54	8,22	50
ONKA - 2003	2/8 = 10 Delikli Pano Top. Klemensi	9	6,5	73	11,13	50
ONKA - 2004	2/10 = 12 Delikli Pano Top. Klemensi	9	6,5	86	12,86	50
ONKA - 2005	2/13 = 15 Delikli Pano Top. Klemensi	9	6,5	105	15,70	50
ONKA - 2006	2/20 = 22 Delikli Pano Top. Klemensi	9	6,5	148	22,25	50
ONKA - 2007	2/40 = 42 Delikli Pano Top. Klemensi	9	6,5	285	41,75	50
ONKA - 2008	2/60 = 62 Delikli Pano Top. Klemensi	9	6,5	410	59,79	50
ONKA - 1999	1 metre, 159 Delikli Pano Top. Klemensi	9	6,5	1000	129,87	50

PANO TOPRAKLAMA KLEMENSLERİ (7 x 12 mm KESİT) 160 AMPER



Kablo kesiti max. 25 mm²

KOD	CİNSİ	A	B	L±2	AD. / ʘ	K. AD.
ONKA - 2021	2/5 = 7 Delikli Pano Top. Klemensi	12	7	69	11,44	50
ONKA - 2022	2/8 = 10 Delikli Pano Top. Klemensi	12	7	93	15,27	50
ONKA - 2023	2/10 = 12 Delikli Pano Top. Klemensi	12	7	119	18,23	50
ONKA - 2024	2/13 = 15 Delikli Pano Top. Klemensi	12	7	133	21,88	50
ONKA - 2025	2/20 = 22 Delikli Pano Top. Klemensi	12	7	188	31,44	50
ONKA - 2029	1 metre, 126 Delikli Pano Top. Klemensi	12	7	1000	158,20	50

PANO TOPRAKLAMA KLEMENSLERİ (10 x 15 mm KESİT) 250 AMPER

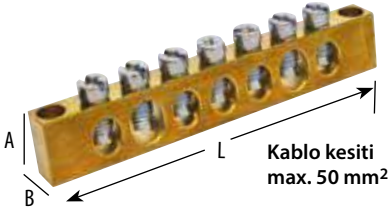

Kablo kesiti max. 50 mm²

KOD	CİNSİ	A	B	L±2	AD. / ʘ	K. AD.
ONKA - 2041	2/5 = 7 Delikli Pano Top. Klemensi	15	10	111	33,39	50
ONKA - 2042	2/8 = 10 Delikli Pano Top. Klemensi	15	10	149	45,24	50
ONKA - 2043	2/10 = 12 Delikli Pano Top. Klemensi	15	10	173	55,22	50
ONKA - 2044	2/13 = 15 Delikli Pano Top. Klemensi	15	10	211	68,90	50
ONKA - 2045	2/20 = 22 Delikli Pano Top. i	15	10	299	100,85	50
ONKA - 2028	1 metre, 79 Delikli Pano Top. Klemensi	15	10	1000	302,69	50

1 KUTUPLU DAĞITICI ÜNİTELER (6.5 x 9 mm) 80 AMPER

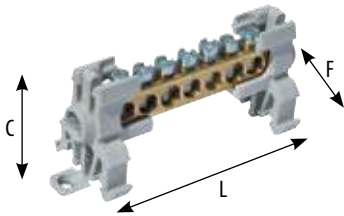

Kablo kesiti max. 10 mm²
(Çok Tellî) - 16 mm²
(Tek Damar)

KOD	CİNSİ	L±2	F±1	C±1	AD. / ʘ	K. AD.
ONKA - 2051	2 / 5 - 7 Delikli	71,4	24	28,2	11,27	32
ONKA - 2052	2 / 8 - 10 Delikli	89,9	24	28,2	14,34	24
ONKA - 2053	2 / 10-12 Delikli	102,4	24	28,2	16,56	18
ONKA - 2054	2 / 13 15 Delikli	120,9	24	28,2	19,71	16
ONKA - 2055	2 / 20-22 Delikli	164,9	24	28,2	27,11	12

Raya montajlı kullanım için ray siparişi ayrıca verilmelidir.

1 KUTUPLU DAĞITICI ÜNİTELER (7 x 12 mm) 160 AMPER

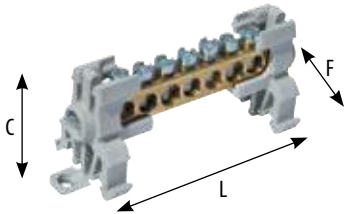

KOD	CİNSİ	L±2	F±1	C±1	AD. / ʘ	K. AD.
ONKA - 2056	2 / 5 - 7 Delikli	83	24	28,2	15,86	32
ONKA - 2057	2 / 8 - 10 Delikli	106,7	24	28,2	20,70	24
ONKA - 2058	2 / 10-12 Delikli	122,5	24	28,2	24,05	18
ONKA - 2059	2 / 13 15 Delikli	146,1	24	28,2	28,05	16
ONKA - 2060	2 / 20-22 Delikli	200,9	24	28,2	38,50	12

Raya montajlı kullanım için ray siparişi ayrıca verilmelidir.

1 KUTUPLU DAĞITICI ÜNİTELER (10 x 15 mm) 250 AMPER

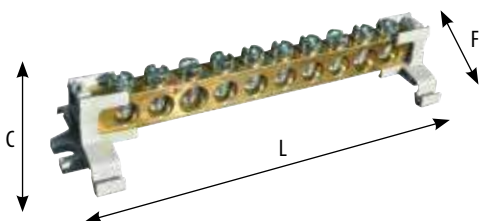

KOD	CİNSİ	L±2	F±1	C±1	AD. / ʘ	K. AD.
ONKA - 2066	2 / 5 - 7 Delikli	121	43,2	39	37,72	32
ONKA - 2067	2 / 8 - 10 Delikli	159	43,2	39	49,79	24
ONKA - 2068	2 / 10-12 Delikli	184	43,2	39	60,01	18
ONKA - 2069	2 / 13 15 Delikli	220,5	43,2	39	73,88	16
ONKA - 2070	2 / 20-22 Delikli	308	43,2	39	106,28	12

Raya montajlı kullanım için ray siparişi ayrıca verilmelidir.

1 KUTUPLU DAĞITICI ÜNİTELER (6.5 x 9 mm) 80 AMPER (Kapaklı Sistem)

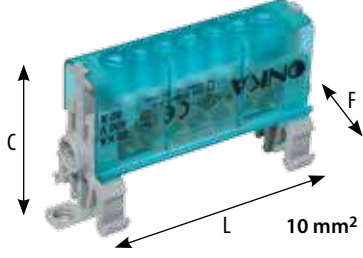

Kablo kesiti max.
10 mm² (Çok Telli) - 16 mm² (Tek Damar)

KOD	CİNSİ	L±2	F±1	C±1	AD. / ʘ	K. AD.
ONKA - 2061	2 / 5 - 7 Delikli	71,4	24	37,5	12,46	32
ONKA - 2062	2 / 8 - 10 Delikli	89,9	24	37,5	15,74	24
ONKA - 2063	2 / 10-12 Delikli	102,4	24	37,5	18,10	18
ONKA - 2064	2 / 13-15 Delikli	120,9	24	37,5	21,78	16
ONKA - 2065	2 / 20-22 Delikli	164,9	24	37,5	29,63	12

Raya montajlı kullanım için ray siparişi ayrıca verilmelidir.

1 KUTUPLU DAĞITICI ÜNİTELER (7 x 12 mm) 160 AMPER (Kapaklı Sistem)

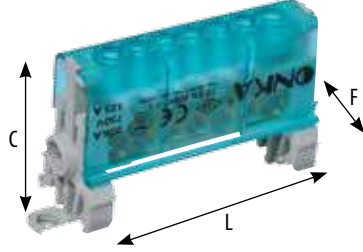

Kablo kesiti max.
25 mm² tek damar ve çok telli

KOD	CİNSİ	L±2	F±1	C±1	AD. / ʘ	K. AD.
ONKA - 2071	2 / 5 - 7 Delikli	83	24	37,5	17,51	32
ONKA - 2072	2 / 8 - 10 Delikli	106,7	24	37,5	22,64	24
ONKA - 2073	2 / 10-12 Delikli	122,5	24	37,5	26,13	18
ONKA - 2074	2 / 13-15 Delikli	146,1	24	37,5	30,67	16
ONKA - 2075	2 / 20-22 Delikli	200,9	24	37,5	41,61	12

Raya montajlı kullanım için ray siparişi ayrıca verilmelidir.

1 KUTUPLU DAĞITICI ÜNİTELER (10 x 15 mm) 250 AMPER (Kapaklı Sistem)

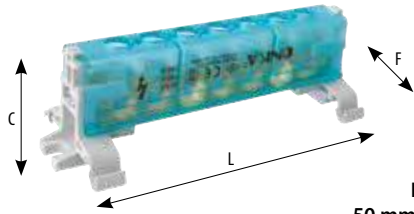

Kablo kesiti max.
50 mm² tek damar ve çok telli

KOD	CİNSİ	L±2	F±1	C±1	AD. / ʘ	K. AD.
ONKA - 2076	2 / 5 - 7 Delikli	121	43,2	38	38,42	32
ONKA - 2077	2 / 8 - 10 Delikli	159	43,2	38	50,93	24
ONKA - 2078	2 / 10-12 Delikli	184	43,2	38	61,52	18
ONKA - 2079	2 / 13-15 Delikli	220,5	43,2	38	75,49	16
ONKA - 2080	2 / 20-22 Delikli	308	43,2	38	108,52	12

Raya montajlı kullanım için ray siparişi ayrıca verilmelidir.

2 KUTUPLU DAĞITICI ÜNİTELER (6.5 x 9 mm) 80 AMPER

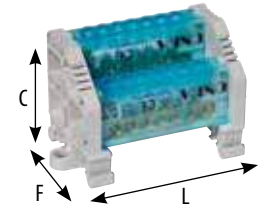

Kablo kesiti max.
10 mm² (Çok Telli) - 16 mm² (Tek Damar)

KOD	CİNSİ	L±2	F±1	C±1	AD. / ʘ	K. AD.
ONKA - 2081	2 / 5 - 7 Delikli	82,7	50,8	46,6	29,38	1
ONKA - 2082	2 / 8 - 10 Delikli	101,7	50,8	46,6	35,69	1
ONKA - 2083	2 / 10-12 Delikli	114,2	50,8	46,6	40,05	1
ONKA - 2084	2 / 13-15 Delikli	132,7	50,8	46,6	48,05	1
ONKA - 2085	2 / 20-22 Delikli	176,5	50,8	46,6	63,26	1

2 KUTUPLU DAĞITICI ÜNİTELER (7 x 12 mm) 160 AMPER

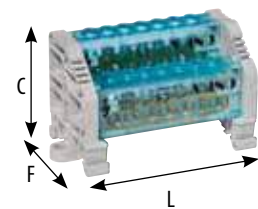

Kablo kesiti max. 25 mm² tek damar ve çok telli

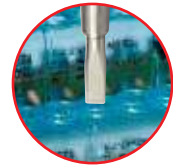

Kapak sökmeden
montajlama avantajı

KOD	CİNSİ	L±2	F±1	C±1	AD. / ʘ	K. AD.
ONKA - 2091	2 / 5 - 7 Delikli	95,2	50,8	46,6	35,25	1
ONKA - 2092	2 / 8 - 10 Delikli	118,7	50,8	46,6	45,26	1
ONKA - 2093	2 / 10-12 Delikli	134,2	50,8	46,6	51,89	1
ONKA - 2094	2 / 13-15 Delikli	157,2	50,8	46,6	61,62	1
ONKA - 2095	2 / 20-22 Delikli	212,2	50,8	46,6	82,97	1

2 KUTUPLU DAĞITICI ÜNİTELER (10 x 15 mm) 250 AMPER

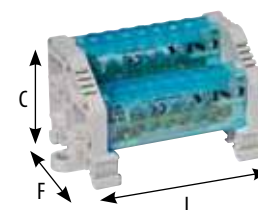

Kablo kesiti max.
50 mm² tek damar ve çok telli

KOD	CİNSİ	L±2	F±1	C±1	AD. / ʘ	K. AD.
ONKA - 2086	2 / 5 - 7 Delikli	135	55	50	95,72	1
ONKA - 2087	2 / 8 - 10 Delikli	172,5	55	50	120,55	1
ONKA - 2088	2 / 10-12 Delikli	197	55	50	142,30	1
ONKA - 2089	2 / 13-15 Delikli	235	55	50	170,10	1
ONKA - 2090	2 / 20-22 Delikli	322,5	55	50	238,96	1

3 KUTUPLU DAĞITICI ÜNİTELER (6.5 x 9 mm) 80 AMPER (Alçak Model)

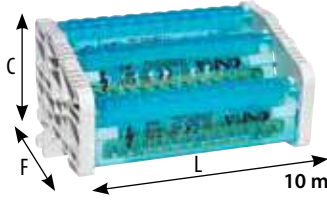

Kablo kesiti max.
10 mm² (Çok Telli) - 16 mm² (Tek Damar)

KOD	CİNSİ	L±2	F±1	C±1	AD. / ƒ	K. AD.
ONKA - 2171	2 / 5 - 7 Delikli	82,7	66	47	43,14	1
ONKA - 2172	2 / 8 - 10 Delikli	101,6	66	47	53,39	1
ONKA - 2173	2 / 10-12 Delikli	113,9	66	47	59,89	1
ONKA - 2174	2 / 13-15 Delikli	132,8	66	47	71,51	1
ONKA - 2175	2 / 20-22 Delikli	176,5	66	47	95,03	1

3 KUTUPLU DAĞITICI ÜNİTELER (7 x 12 mm) 160 AMPER (Alçak Model)

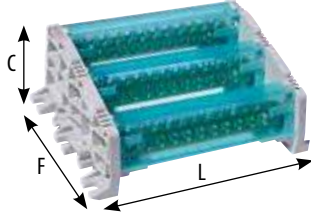

Kablo kesiti max.
25 mm² tek damar ve çok telli

KOD	CİNSİ	L±2	F±1	C±1	AD. / ƒ	K. AD.
ONKA - 2151	2 / 5 - 7 Delikli	95	66	47	56,31	1
ONKA - 2152	2 / 8 - 10 Delikli	118,5	66	47	71,30	1
ONKA - 2153	2 / 10-12 Delikli	134	66	47	82,07	1
ONKA - 2154	2 / 13-15 Delikli	157	66	47	95,44	1
ONKA - 2155	2 / 20-22 Delikli	212	66	47	128,29	1

3 KUTUPLU DAĞITICI ÜNİTELER (10 x 15 mm) 250 AMPER (Alçak Model)

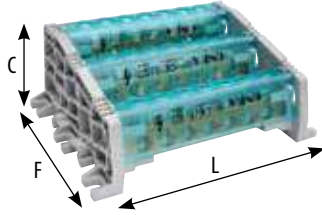

Kablo kesiti max.
50 mm² tek damar ve çok telli

KOD	CİNSİ	L±2	F±1	C±1	AD. / ƒ	K. AD.
ONKA - 2181	2 / 5 - 7 Delikli	117	94,5	50	135,13	1
ONKA - 2182	2 / 8 - 10 Delikli	154,5	94,5	50	172,33	1
ONKA - 2183	2 / 10-12 Delikli	179	94,5	50	205,15	1
ONKA - 2184	2 / 13-15 Delikli	217	94,5	50	246,81	1
ONKA - 2185	2 / 20-22 Delikli	304,5	94,5	50	348,43	1

3 KUTUPLU DAĞITICI ÜNİTELER (10 x 15 mm) 250 AMPER (Yüksek Model)

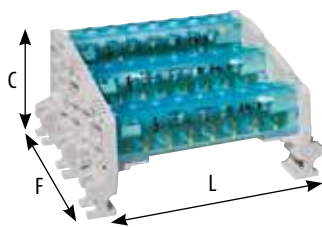

Kablo kesiti max.
50 mm² tek damar ve çok telli

KOD	CİNSİ	L±2	F±1	C±1	AD. / ƒ	K. AD.
ONKA - 2186	2 / 5 - 7 Delikli	135	95	65	138,41	1
ONKA - 2187	2 / 8 - 10 Delikli	172,5	95	65	175,61	1
ONKA - 2188	2 / 10-12 Delikli	197	95	65	208,43	1
ONKA - 2189	2 / 13-15 Delikli	235	95	65	250,90	1
ONKA - 2190	2 / 20-22 Delikli	322,5	95	65	351,71	1

4 KUTUPLU DAĞITICI ÜNİTELER (6.5 x 9 mm) 80 AMPER (Alçak Model)

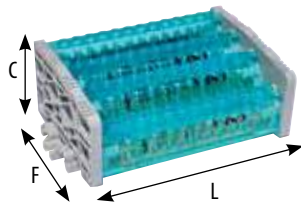

Kablo kesiti max.
10 mm² (Çok Telli) - 16 mm² (Tek Damar)

KOD	CİNSİ	L±2	F±1	C±1	AD. / ƒ	K. AD.
ONKA - 2201	2 / 5 - 7 Delikli	85,8	86	48,5	53,30	1
ONKA - 2202	2 / 8 - 10 Delikli	104,7	86	48,5	66,67	1
ONKA - 2203	2 / 10-12 Delikli	117	86	48,5	75,37	1
ONKA - 2204	2 / 13-15 Delikli	135,9	86	48,5	90,53	1
ONKA - 2205	2 / 20-22 Delikli	179,6	86	48,5	121,66	1

4 KUTUPLU DAĞITICI ÜNİTELER (7 x 12 mm) 160 AMPER (Alçak Model)

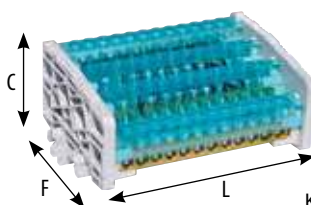

Kablo kesiti max. 25 mm² tek damar ve çok telli

Kapak sökmeden Kablo önden ve arkadan giriş imkanı

KOD	CİNSİ	L±2	F±1	C±1	AD. / ƒ	K. AD.
ONKA - 2211	2 / 5 - 7 Delikli	97,7	86	48,5	69,81	1
ONKA - 2212	2 / 8 - 10 Delikli	121,2	86	48,5	84,79	1
ONKA - 2213	2 / 10-12 Delikli	136,7	86	48,5	103,01	1
ONKA - 2214	2 / 13-15 Delikli	159,7	86	48,5	121,62	1
ONKA - 2215	2 / 20-22 Delikli	214,7	86	48,5	164,37	1

4 KUTUPLU DAĞITICI ÜNİTELER (10 x 15 mm) 250 AMPER

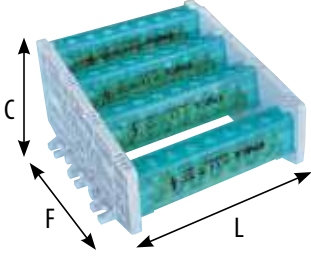

Kablo kesiti max.
50 mm² tek damar ve çok telli

KOD	CİNSİ	L±2	F±1	C±1	AD. / ʘ	K. AD.
ONKA - 2116	2 / 5 - 7 Delikli	135,5	130	68	176,92	1
ONKA - 2117	2 / 8 - 10 Delikli	172,6	130	68	226,49	1
ONKA - 2118	2 / 10-12 Delikli	197	130	68	268,36	1
ONKA - 2119	2 / 13-15 Delikli	235	130	68	325,46	1
ONKA - 2120	2 / 20-22 Delikli	322,5	130	68	458,26	1

4 KUTUPLU DAĞITICI ÜNİTELER (6.5 x 9 mm) 80 AMPER (Yüksek Model)

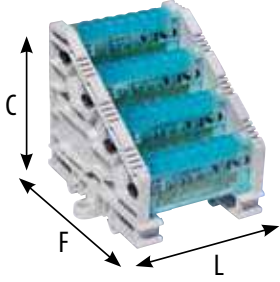

Kablo kesiti max.
10 mm² (Çok Tellili) - 16 mm²
(Tek Damar)

KOD	CİNSİ	L±2	F±1	C±1	AD. / ʘ	K. AD.
ONKA - 2101	2 / 5 - 7 Delikli	84,3	86,5	82,3	57,72	1
ONKA - 2102	2 / 8 - 10 Delikli	103,2	86,5	82,3	71,09	1
ONKA - 2103	2 / 10-12 Delikli	115,5	86,5	82,3	79,79	1
ONKA - 2104	2 / 13-15 Delikli	134,4	86,5	82,3	94,95	1
ONKA - 2105	2 / 20-22 Delikli	178,1	86,5	82,3	125,30	1

4 KUTUPLU DAĞITICI ÜNİTELER (7 x 12 mm) 160 AMPER (Yüksek Model)

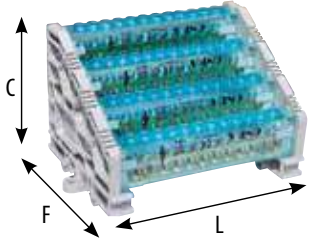

Kablo kesiti max.
25 mm² tek damar ve çok telli

KOD	CİNSİ	L±2	F±1	C±1	AD. / ʘ	K. AD.
ONKA - 2111	2 / 5 - 7 Delikli	95,5	86,5	82,3	71,30	1
ONKA - 2112	2 / 8 - 10 Delikli	119,5	86,5	82,3	91,27	1
ONKA - 2113	2 / 10-12 Delikli	135	86,5	82,3	105,29	1
ONKA - 2114	2 / 13-15 Delikli	158	86,5	82,3	123,90	1
ONKA - 2115	2 / 20-22 Delikli	213	86,5	82,3	166,64	1

5 KUTUPLU DAĞITICI ÜNİTELER (10 x 15 mm) 250 AMPER

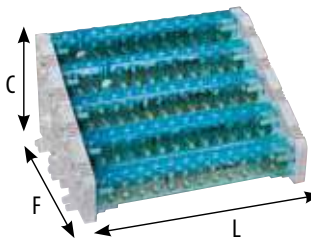

Kablo kesiti max.
50 mm² tek damar ve çok telli

KOD	CİNSİ	L±2	F±1	C±1	AD. / ʘ	K. AD.
ONKA - 2191	2 / 5 - 7 Delikli	143	150	96	213,95	1
ONKA - 2192	2 / 8 - 10 Delikli	180,5	150	96	277,48	1
ONKA - 2193	2 / 10-12 Delikli	205	150	96	331,09	1
ONKA - 2194	2 / 13-15 Delikli	243	150	96	402,04	1
ONKA - 2195	2 / 20-22 Delikli	329	150	96	569,20	1

5 KUTUPLU DAĞITICI ÜNİTELER (10 x 15 mm) 250 AMPER (Yüksek Model)

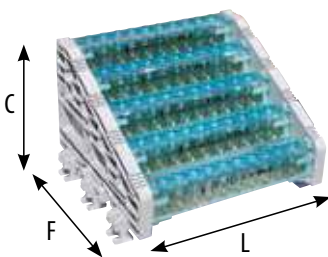

Kablo kesiti max.
50 mm² tek damar ve çok telli



KOD	CİNSİ	L±2	F±1	C±1	AD. / ʘ	K. AD.
ONKA - 2216	2 / 5 - 7 Delikli	143	150	111	217,23	1
ONKA - 2217	2 / 8 - 10 Delikli	180,5	150	111	280,76	1
ONKA - 2218	2 / 10-12 Delikli	205	150	111	334,37	1
ONKA - 2219	2 / 13-15 Delikli	243	150	111	405,35	1
ONKA - 2220	2 / 20-22 Delikli	329	150	111	572,47	1

5 KADEMELİ 30 x 5 mm BAKIR BARA DAĞITICI ÜNİTELER VE AKSESUARI



KOD	CİNSİ	AD. / ƒ	K. AD.
ONKA-2131	5 Katlı Dağıtıcı Ünite (Max. 30x5) Yatak	37,20	10

DAĞITICI ÜNİTE YÜKSELTİCİ AYAKLARI



KOD	CİNSİ	AD. / ƒ	K. AD.
ONKA-2134	1 - 3 - 5'li dağıtıcı üniteler için yükseltme ayakları	0,61	100

DAĞITICI ÜNİTE ALT İZOLASYON APARATI

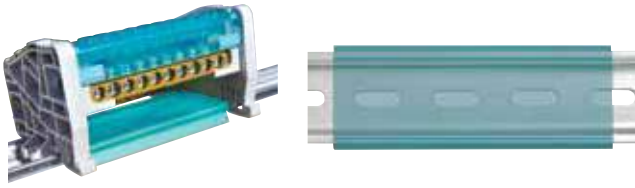

KOD	CİNSİ	AD. / ƒ	K. AD.
ONKA-2137	35 mm örtme aparatı (1 m)	4,72	10

TEKNİK ÖZELLİKLER

KESİT ÖLÇÜLERİ (mm)	KÜÇÜK DELİK ÇAPI	BÜYÜK DELİK ÇAPI	AKIM	TEK DAMAR KABLO KESİTİ	ÇOK TELLİ KABLO KESİTİ
6,5 x 9	4,8 mm	5,5 mm	80 A	16 mm ²	10 mm ²
7 x 12	6 mm	7,5 mm	160 A	25 mm ²	25 mm ²
10 x 15	8,5 mm	10,3 mm	250 A	50 mm ²	50 mm ²

Onka®



MONOFAZE MÜŞTEREK W OTOMAT BARALARI (İĞNE TİP)



Kod: 3000

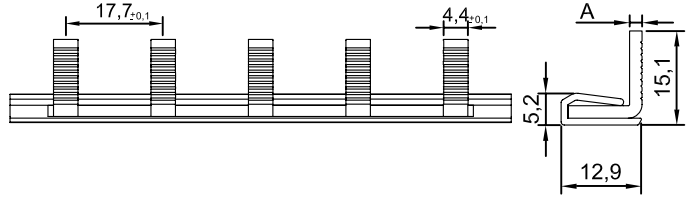

1500 VDC

KOD	1 mm 80 A AD. / ʈ	KOD	1.5 mm 100 A AD. / ʈ	KOD	2 mm 125 A AD. / ʈ	MODÜL AD.	K. AD.	
ONKA-3006	16,50	ONKA-3001	23,12	ONKA-3011	28,70	12	50	
ONKA-3007	23,01	ONKA-3002	32,93	ONKA-3012	41,30	18	50	
ONKA-3008	29,51	ONKA-3003	42,75	ONKA-3013	53,90	24	50	
ONKA-3009	36,02	ONKA-3004	52,56	ONKA-3014	66,50	30	50	
ONKA-3010	64,21	ONKA-3005	95,08	ONKA-3015	121,13	56	50	
ONKA-3000	0,12	Monofaze Bara Yan Kapak						100

2 FAZLI MÜŞTEREK W OTOMAT BARALARI (İĞNE TİP)

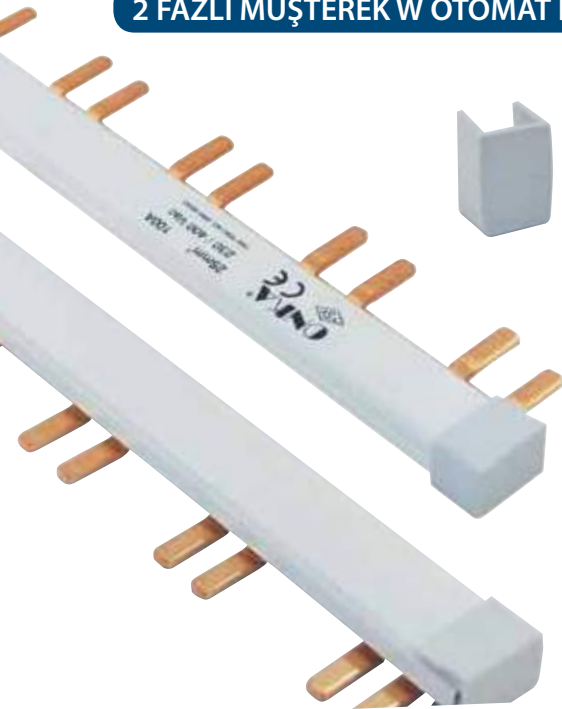

Kod: 3026

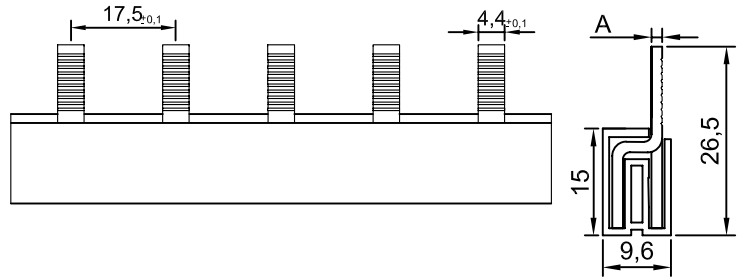

1500 VDC

KOD	1 mm 80 A AD. / ʈ	KOD	1.5 mm 100 A AD. / ʈ	CİNSİ	MODÜL AD.	K. AD.
ONKA-3021	28,95	ONKA-3031	38,00	İğne Tip	6	30
ONKA-3022	40,88	ONKA-3032	54,46	İğne Tip	9	30
ONKA-3023	52,80	ONKA-3033	70,91	İğne Tip	12	30
ONKA-3024	64,72	ONKA-3034	87,32	İğne Tip	15	30
ONKA-3025	116,72	ONKA-3035	159,01	İğne Tip	28	30
ONKA-3026	0,23	İki Fazlı Müşterek W Otomat Barası Yan Kapak				100

TRİFAZE MÜŞTEREK W OTOMAT BARALARI (İĞNE TİP)

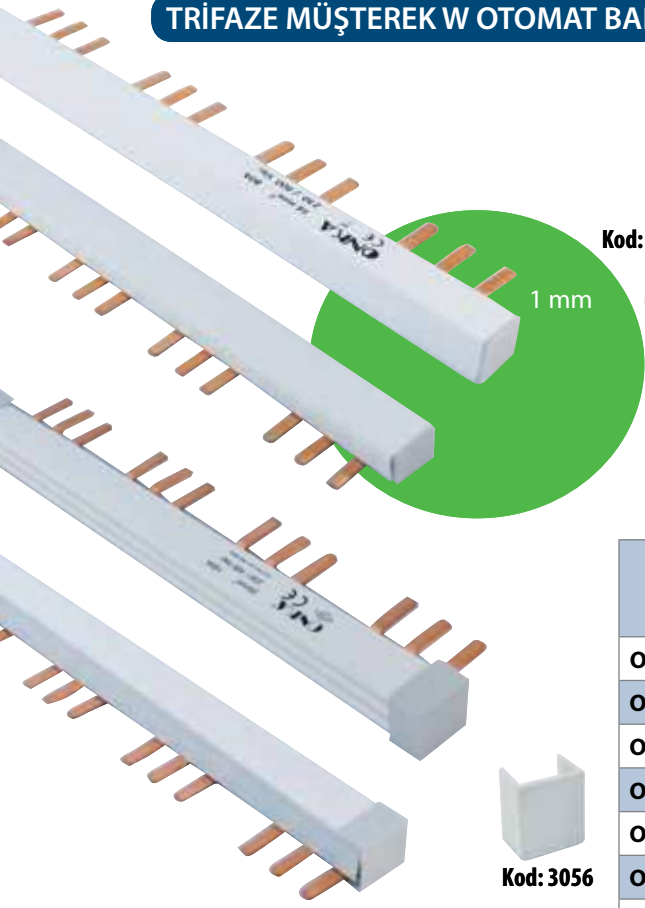

Kod: 5833

1 mm

Kod: 3056

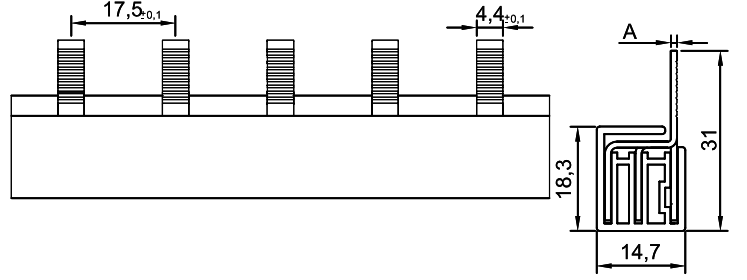

KOD	1 mm 80 A AD. / ʈ	KOD	1.5 mm 100 A AD. / ʈ	KOD	2 mm 125 A AD. / ʈ	MODÜL AD.	K. AD.	
ONKA-3041	44,60	ONKA-3051	61,48	ONKA-3066	75,33	4	30	
ONKA-3042	63,58	ONKA-3052	88,92	ONKA-3067	109,67	6	30	
ONKA-3043	82,62	ONKA-3053	116,37	ONKA-3068	144,13	8	30	
ONKA-3044	101,67	ONKA-3054	143,80	ONKA-3069	178,60	10	30	
ONKA-3045	194,72	ONKA-3055	279,40	ONKA-3070	348,15	20	25	
ONKA-3056	0,25	Trifaze Bara Yan Kapak						100
ONKA-5833	0,25	1 mm Trifaze Bara Yan Kapak						100

3 FAZ + NÖTR MÜŞTEREK W OTOMAT BARALARI (İĞNE TİP)

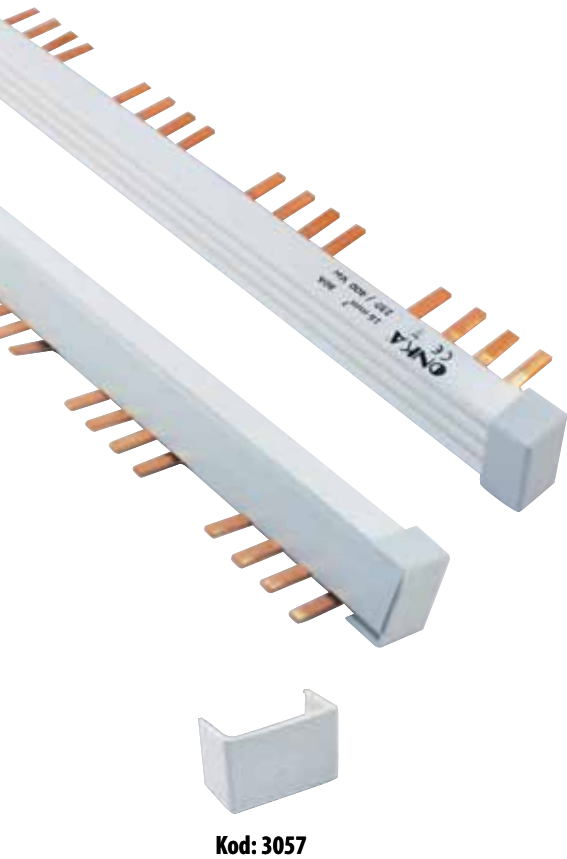

Kod: 3057

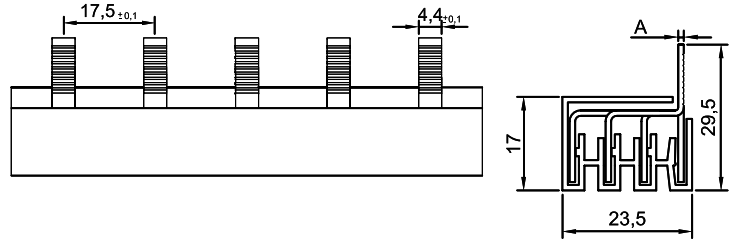

KOD	1.5 mm 100 A AD. / ʈ	KOD	2 mm 125 A AD. / ʈ	MODÜL AD.	K. AD.
ONKA-3058		ONKA-3072		4	16
ONKA-3059		ONKA-3073		8	16
ONKA-3060	389,22	ONKA-3074	499,26	14	16
ONKA-3057	0,41	3 Faz + Nötr Müşterek W Oto. Barası Yan Kapak			100

İZOLASYONLU MOTOR KORUMA BARALARI (63 AKIM)

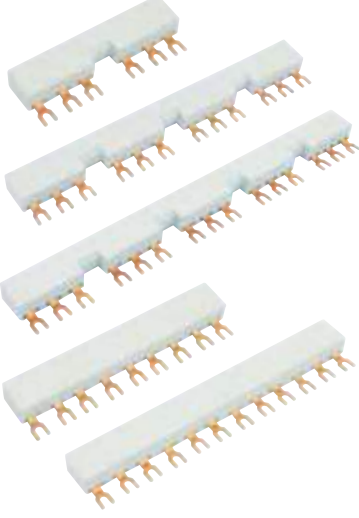

KOD	CİNSİ	AD. / €	K. AD.
ONKA-MSVG54-14-2	Motor Koruma Barası, İkili Modül, Adım Genişliği 45 + 9 = 54 mm	9,55 €	1
KOD	CİNSİ	AD. / €	K. AD.
ONKA-MSVG54-14-4	Motor Koruma Barası, Dörtlü Modül, Adım Genişliği 45 + 9 = 54 mm	13,85 €	1
KOD	CİNSİ	AD. / €	K. AD.
ONKA-MSVG54-14-5	Motor Koruma Barası, Beşli Modül, Adım Genişliği 45 + 9 = 54 mm	13,55 €	1
KOD	CİNSİ	AD. / €	K. AD.
ONKA-MSVG45-14-3	Motor Koruma Barası, Üçlü Mod, boşluk yok, Adım Gen. 45 mm	11,50 €	1
KOD	CİNSİ	AD. / €	K. AD.
ONKA-MSVG45-14-4	Motor Koruma Barası, Dörtlü Mod, boşluk yok, Adım Gen. 45 mm	13,35 €	1

MONOFAZE W OTOMAT BARASI, İĞNE TİP (2 mm)

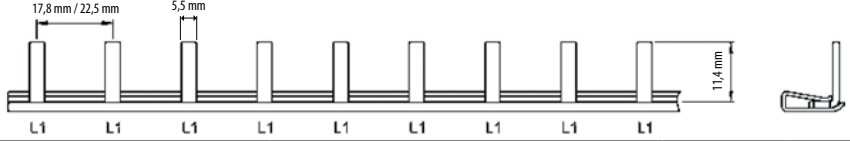
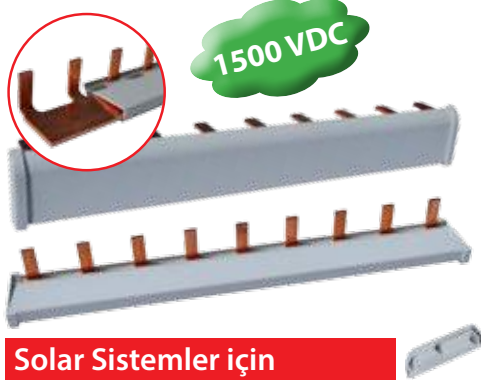

KOD	AÇIKLAMA	AD. / €	K. AD.
FTG-6905S-06TE-EK	1-faz, pin, 35 mm ² , 6 mod, 17,8 mm pin aralığı, 90°	8,10 €	1
FTG-6905S-08TE-EK	1-faz, pin, 35 mm ² , 8 mod, 17,8 mm pin aralığı, 90°	10,25 €	1
FTG-6905S-CY	1-faz, pin, 35 mm ² , 57 mod, 17,8 mm pin aralığı, 90°	59,50 €	1
FTG-6907S-06TE-EK	1-faz, pin, 35 mm ² , 6 mod, 22,5 mm pin aralığı, 90°	8,60 €	1
FTG-6907S-08TE-EK	1-faz, pin, 35 mm ² , 8 mod, 22,5 mm pin aralığı, 90°	11,05 €	1
FTG-6907S-CY	1-faz, pin, 35 mm ² , 44 mod, 22,5 mm pin aralığı, 90°	59,55 €	1
FTG-A61	Yan Kapak	1,5 €	1

Solar Sistemler için

(L1+N, L2+N, L3+N) MÜŞTEREK W OTOMAT BARA, İĞNE TİP (80 AKIM)

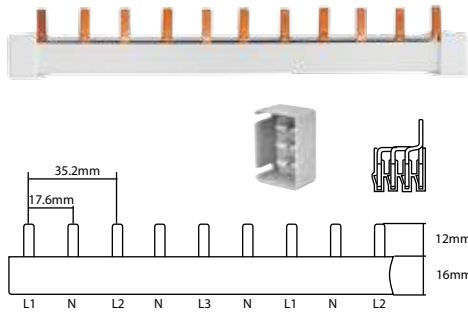

KOD	AÇIKLAMA	AD. / €	K. AD.
FTG-4S16L54A0A0N-01	L1 + N, L2 + N, L3 + N ... 13 MODÜL 1 mt	75 €	1
FTG-A2	Müşterek W Oto. Barası Yan Kapak	0,72 €	1

MODÜLER GÜÇ KLEMENSLERİ (Monofaze-Difaze-Trifaze Bağlantı Klemensi)

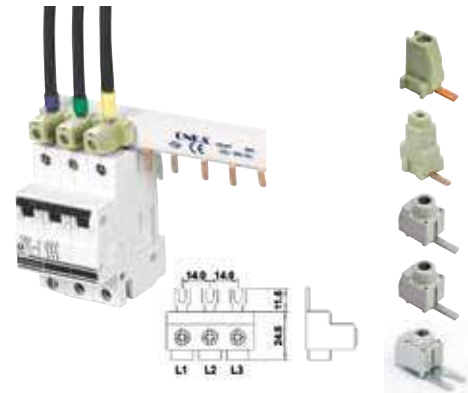

KOD	CİNSİ	ADET	K. AD.
ONKA-3061	No.1 (2.5 - 10 mm ²)	3,19 ₺	150
ONKA-3065	No.2 (16 - 25 mm ²)	5,01 ₺	100
FTG-802/115 S	No.2 (6 - 25 mm ²)	1,95 €	30
FTG-802/215 S	No.3 (6 - 50 mm ²)	2,55 €	25
FTG-802/114	No.2 (6 - 25 mm ²) Çatal Uçlu	1,95 €	25
FTG-MSV GE 1-14	No.2 (6 - 25 mm ²) Çatal Uçlu, Üçlü (L1,L2,L3)	9,50 €	1

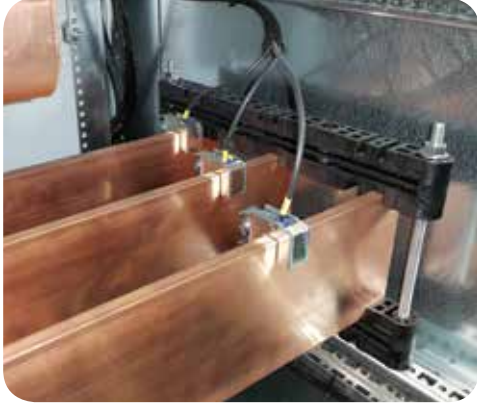

BAKIR BARA BAĞLANTI KLEMENSİ (YAY BASKILI) 16 mm²

KOD	CİNSİ	AKIM	GERİLİM	AD. / ʘ	K. AD.
ONKA-2140	SK16 F5 Bakır Bara Klemensi, 1,5 - 16 mm ²	180	690	5,50	100
ONKA-2141	SK16 F10 Bakır Bara Klemensi, 1,5 - 16 mm ²	180	690	5,67	100

BAKIR BARA BAĞLANTI KLEMENSİ (YAY BASKILI) 35 mm²

KOD	CİNSİ	AKIM	GERİLİM	AD. / ʘ	K. AD.
ONKA-2142	SK35 F5 Bakır Bara Klemensi, 1,5 - 35 mm ²	270	690	9,53	50
ONKA-2143	SK35 F10 Bakır Bara Klemensi, 1,5 - 35 mm ²	270	690	10,08	50

BAKIR BARA BAĞLANTI KLEMENSİ (YAY BASKILI) 70 mm²

KOD	CİNSİ	AKIM	GERİLİM	AD. / ʘ	K. AD.
ONKA-2144	SK70 F5 Bakır Bara Klemensi, 16 - 70 mm ²	400	690	21,75	10
ONKA-2145	SK70 F10 Bakır Bara Klemensi, 16 - 70 mm ²	400	690	25,55	10

BAKIR BARA BAĞLANTI KLEMENSİ (YAY BASKILI) 120 mm²

KOD	CİNSİ	AKIM	GERİLİM	AD. / ʘ	K. AD.
ONKA-2146	SK120 F5 Bakır Bara Klemensi, 16 - 120 mm ²	440	690	36,53	10
ONKA-2147	SK120 F10 Bakır Bara Klemensi, 16 - 120 mm ²	440	690	38,90	10

GEÇMELİ BAKIR BARA BAĞLANTI KLEMENSLERİ (PALETLİ SİSTEM)

KOD	CİNSİ	AKIM	GERİLİM	AD. / ʘ	K. AD.
ONKA-2159	12 x 3 mm Bakır Bara için Klemens 4 mm ² kablo kesiti	80	690	2,10	300
ONKA-2160	12 x 3 mm Bakır Bara için Klemens 16 mm ² kablo kesiti	80	690	2,24	300
ONKA-2161	12 x 3 mm Bakır Bara için Klemens 35 mm ² kablo kesiti	100	690	2,68	250
ONKA-2162	12 x 3 mm Elektrolitik Bakır Bara 1 mt.			1	1 mt.

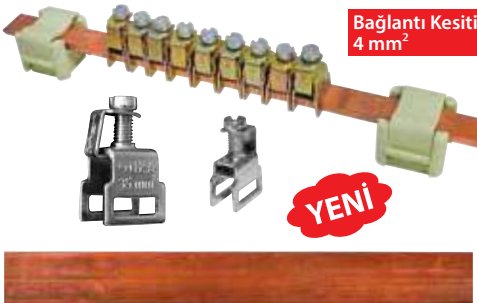
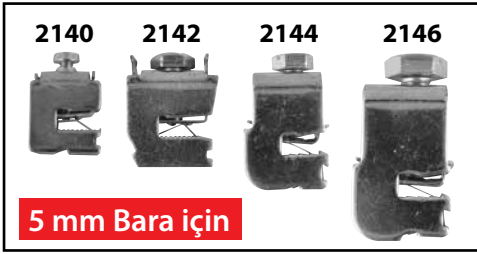

(NÖTR) VİDALI TOPRAKLAMA BARALARI

ÜRÜN KODU	ÖZELLİKLER / KESİT		Akım (A)	AD. / ʘ	K. AD.
	Vida	Kalınlık			
ONKA - 3075	31	1.5x15mm	100	99,90	25
ONKA - 3076	62	1.5x15mm	100	114,03	25
ONKA - 3080	31	2x15mm	125	125,78	25
ONKA - 3087	62	2x15mm	125	139,90	25
ONKA - 3088	31	3x15mm	150	174,89	25
ONKA - 3086	62	3x15mm	150	189,01	25

(NÖTR) VİDALI TOPRAKLAMA BARA MESNEDİ

KOD	CİNSİ	AD. / ʘ	K. AD.
ONKA-3091	Kumanda Bara Mesnedi	1,74	100



Onka®



DIN 46277-3 / TS EN 60715
Standartlarına Uygundur.





0 FİRE + 0 KOROZYON + 0 İŞÇİLİK = MALİYET KAZANCI

İSTENİLEN
ÖLÇÜDE KESİM
FİREDE KAZANÇ

KESİMDEN SONRA
KAPLAMA
KALİTEDE KAZANÇ

ZAMAN
KAYBINDAN
KAZANÇ

cm Fiyatı



35 x 7,5 GALVANİZ KAPLI DÜZ MONTAJ RAYLARI

KOD	CİNSİ	AD. ʈ	K. AD.
ONKA-4211	30 cm	4,32	100
ONKA-4212	1 m	13,47	50
ONKA-4213	2 m	26,66	50

35 x 7,5 GALVANİZ KAPLI DELİKLİ SAC MONTAJ RAYLARI

KOD	CİNSİ	AD. ʈ	K. AD.
ONKA-4221	30 cm	4,53	100
ONKA-4222	1 m	13,47	50
ONKA-4223	2 m	26,66	50

35 x 15 GALVANİZ KAPLI DÜZ MONTAJ RAYLARI

KOD	CİNSİ	AD. ʈ	K. AD.
ONKA-4231	30 cm	7,97	100
ONKA-4232	1 m	24,83	25
ONKA-4233	2 m	50,03	25

35 x 15 GALVANİZ KAPLI DELİKLİ MONTAJ RAYLARI

KOD CR + 3	CİNSİ	AD. ʈ	K. AD.
ONKA-4241	30 cm	8,36	100
ONKA-4242	1 m	24,83	25
ONKA-4243	2 m	49,33	25

15 x 5,5 GALVANİZ KAPLI DÜZ MONTAJ RAYLARI

KOD	CİNSİ	AD. ʈ	K. AD.
ONKA-4246	30 cm	2,33	
ONKA-4247	1 m	6,93	
ONKA-4248	2 m	???	

15 x 5,5 GALVANİZ KAPLI DELİKLİ MONTAJ RAYLARI

KOD	CİNSİ	AD. ʈ	K. AD.
ONKA - 4251	30 cm	2,60	100
ONKA - 4252	1 m	6,93	100
ONKA - 4253	2 m	???	100



35 x 7,5 DÜZ SAC MONTAJ RAYLARI (CR 3 KAP.)



KOD CR + 3	CİNSİ	AD. t	K. AD.
ONKA-4021	30 cm	5,91	100
ONKA-4022	1 m	18,79	50
ONKA-4023	2 m	35,74	50

35 x 7,5 DELİKLİ SAC MONTAJ RAYLARI (CR 3 KAP.)



KOD CR + 3	CİNSİ	AD. t	K. AD.
ONKA-4031	30 cm	6,17	100
ONKA-4032	1 m	18,79	50
ONKA-4033	2 m	35,74	50

35 x 15 DÜZ SAC MONTAJ RAYLARI (CR 3 KAP.)



KOD CR + 3	CİNSİ	AD. t	K. AD.
ONKA-4061	30 cm	10,70	100
ONKA-4062	1 m	34,45	25
ONKA-4063	2 m	69,70	25

35 x 15 DELİKLİ SAC MONTAJ RAYLARI (CR 3 KAP.)

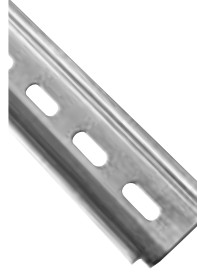

KOD CR + 3	CİNSİ	AD. t	K. AD.
ONKA-4071	30 cm	9,30	100
ONKA-4072	1 m	28,71	25
ONKA-4073	2 m	58,08	25

15 x 5,5 DÜZ SAC MONTAJ RAYLARI (CR 3 KAP.)



KOD CR + 3	CİNSİ	AD. t	K. AD.
ONKA-4101	30 cm	2,89	100
ONKA-4102	1 m	9,03	100
ONKA-4103	2 m	???	100

15 x 5,5 DELİKLİ SAC MONTAJ RAYLARI (CR 3 KAP.)



KOD CR + 3	CİNSİ	AD. t	K. AD.
ONKA-4111	30 cm	2,80	100
ONKA-4112	1 m	7,52	100
ONKA-4113	2 m	???	100

35 x 7,5 DÜZ ALÜMİNYUM MONTAJ RAYLARI

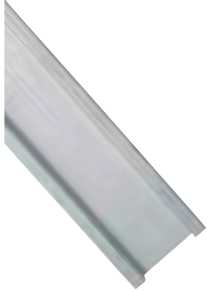

KOD	CİNSİ	AD. / t	K. AD.
ONKA - 4121	30 cm	11,33	100
ONKA - 4122	1 m	36,21	35
ONKA - 4123	2 m	???	25

35 x 7,5 DELİKLİ ALÜMİNYUM MONTAJ RAYLARI



KOD	CİNSİ	AD. / t	K. AD.
ONKA - 4131	30 cm	11,59	100
ONKA - 4132	1 m	36,99	35
ONKA - 4133	2 m	???	25

MG TİPİ DÜZ ALÜMİNYUM MONTAJ RAYLARI



KOD	CİNSİ	AD. / t	K. AD.
ONKA - 4141	30 cm	17,05	25
ONKA - 4142	1 m	56,66	25
ONKA - 4143	2 m	???	25

MG TİPİ DELİKLİ ALÜMİNYUM MONTAJ RAYLARI



KOD	CİNSİ	AD. / t	K. AD.
ONKA - 4146	30 cm	17,31	25
ONKA - 4147	1 m	56,66	25
ONKA - 4148	2 m	???	25

RAY TAŞIYICI (SAC CR + 3)



KOD	CİNSİ	AD./ ʘ	K. AD.
ONKA - 4172	Ray Taşıyıcı Sac Krom	2,09	100

RAY TAŞIYICI (ALÜMİNYUM)



KOD	CİNSİ	AD./ ʘ	K. AD.
ONKA - 4161	Ray Taşıyıcı Alüminyum	ʘ	100

RAY KESME MAKASI



CİNSİ	AD./ ʘ	K. AD.
1 çeşit ray (35x7,5) keser ve raya ʘ 5,5 mm delik deler.	ʘ	1
2 çeşit ray (35x7,5 - 35x15) keser ve raya ʘ 5,5 mm delik deler.	ʘ	1
3 çeşit ray (5,5x15-7,5x35-15x35) ve 3x30 mm bakır barayı keser. Raya ʘ 5,5 mm delik deler ve ʘ 8 Tij deler.	ʘ	1
3 çeşit ray (5,5x15-7,5x35-15x35) ve 3x30 mm bakır barayı keser. Raya ʘ 5,5 mm delik deler	ʘ	1
4 çeşit ray (5,5x15-7,5x35-10x35-15x35) ve 3x30 mm bakır barayı keser. Raya ʘ 5,5 mm delik deler	ʘ	1

ALÜMİNYUM YÜKSELTİCİ



KOD	ÖLÇÜ (mm)	KOLİ ADET	AD./ ʘ
BA16050	ʘ16x50 mm	100	ʘ
BA16080	ʘ16x80 mm	100	ʘ
BA16100	ʘ16x100 mm	100	ʘ



KOD	ÖLÇÜ (mm)	KOLİ ADET	AD./ ʘ
BC16050	ʘ16x50 mm	100	ʘ
BC16080	ʘ16x80 mm	100	ʘ
BC16100	ʘ16x100 mm	100	ʘ

U PROFİL DESTEK RAYI (Cr 3)



KOD	CİNSİ	AD. / TL	K. AD.
ONKA- 4191	1 Metre U Profil (Cr3)	31,79	35
ONKA- 4192	2 Metre U Profil (Cr3)	51,30	35
ONKA- 4193	3 Metre U Profil (Cr3)	76,94	35

KÖŞE APARATI (PANO KAPAKLARI İÇİN)



KOD	CİNSİ	AD. / TL	K. AD.
ONKA- 4195	Sağ/Sol Köşe Aparatı	2,58	100

W OTOMAT RAYI İZOLASYON APARATI



KOD	CİNSİ	AD. / ʘ	K. AD.
ONKA - 2137	35'lik İzolasyon Aparatı (1 m)	4,72	10

Onka®

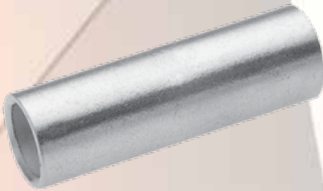

EN 61238-1



STANDART SKP SIKMALI KABLO PAPUÇLARI (BAKIR)

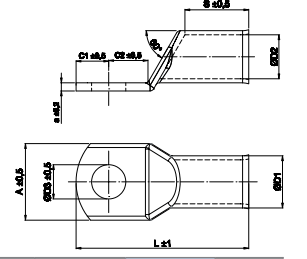
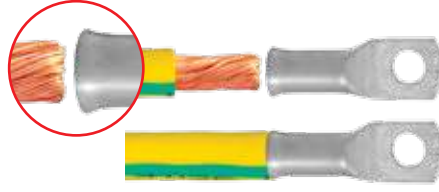

KOD	REF. NO	KABLO KESİTİ mm ²	ÇİVATA	ØD1 (mm)	ØD2 (mm)	L (mm)	ØD3 (mm)	A (mm)	C1 (mm)	C2 (mm)	a (mm)	s (mm)	AĞIRLIK (gr./Ad.)	AD. / ʘ	K.AD
ONKA-6250	SKP-6	6	M5/M6	5.5	4	24	5.5	7.9	6	5	1,5	9	2	1,27	1500
ONKA-6251	SKP-10	10	M5/M6	6.5	5	24.9	5.5	9.4	5.7	6.3	1,5	9	2,5	1,47	1250
ONKA-6252	SKP-16	16	M6/M8	7	5.5	27.7	6.5	10.3	6.4	5.6	1,5	10,5	3	1,73	750
ONKA-6253	SKP-25	25	M6/M8	9	7.5	34	8.5	13.4	7.5	8.5	1,5	11,5	5	2,71	450
ONKA-6254	SKP-35	35	M6/M8/M10	10.5	8.5	39	8.5	15.6	8.7	9.3	2	14	9	4,72	300
ONKA-6255	SKP-50	50	M8/M10/M12/M14	12	10	46.6	10.5	17.8	10.3	11.2	2	18	13	6,26	175
ONKA-6256	SKP-70	70	M8/M10/M12/M14	14	11.5	49.2	10.5	20.4	10.7	10.8	2,5	18,5	20	9,67	125
ONKA-6257	SKP-95	95	M8/M10/M12/M14	16	13.5	53.5	10.5	23.7	10.3	11.7	2,5	21	24	12,51	75
ONKA-6258	SKP-120	120	M10/M12/M14/M16	18	15.5	64	13	27	13.7	13.3	2,5	25	36	17,72	50
ONKA-6259	SKP-150	150	M10/M12/M14/M16	20	16.5	71.2	13	29.4	17.4	16.6	3,5	24	59	29,28	40
ONKA-6260	SKP-185	185	M10/M12/M14/M16/M20	22	18.5	77	17	32.4	17.4	17.6	3,5	28	69	35,10	30
ONKA-6261	SKP-240	240	M10/M12/M14/M16/M20	25.5	21.5	83.5	17	37.6	17.4	17.6	4	32	107	49,20	25

EXTRA STANDART SKP SIKMALI KABLO PAPUÇLARI (UZUN ve KALIN TİP) (BAKIR)

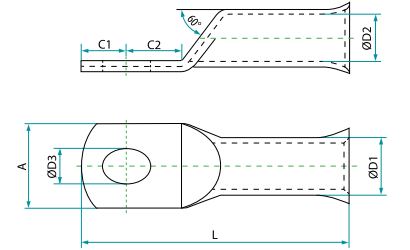
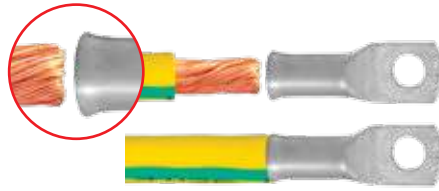

KOD	REF. NO	KABLO KESİTİ mm ²	ÇİVATA	ØD1 (mm)	ØD2 (mm)	L (mm)	ØD3 (mm)	A (mm)	C1 (mm)	C2 (mm)	a (mm)	s (mm)	AĞIRLIK (gr./Ad.)	AD. / ʘ	K.AD
ONKA-6025	SKP-6	6	M5/M6	5.5	4	25.7	5.5	7.9	6	5	1,5	11,5	2	1,37	1500
ONKA-6026	SKP-10	10	M5/M6	6.5	5	27.3	5.5	9.5	5.6	6.4	1,5	12	3	1,57	1000
ONKA-6027	SKP-16	16	M6/M8	7.8	5.8	29.7	6.5	11.2	5.6	6.4	2	13	4	2,64	600
ONKA-6028	SKP-25	25	M6/M8	9.5	7.2	40	8.5	13.5	7.3	8.3	2,3	17,5	10	4,69	300
ONKA-6029	SKP-35	35	M6/M8/M10	10.8	8.5	43.3	8.5	15.7	8.6	9.4	2,3	18,5	12	6,70	250
ONKA-6030	SKP-50	50	M8/M10/M12/M14	13	10	51.2	10.5	18.7	10.5	11	3	23	21	10,76	150
ONKA-6031	SKP-70	70	M8/M10/M12/M14	14.7	11.5	55	10.5	21.2	10,5	11	3,2	25	30	14,45	100
ONKA-6032	SKP-95	95	M8/M10/M12/M14	16.7	13.5	59.6	10.5	24.5	10.5	11.5	3,2	27	37	17,37	75
ONKA-6033	SKP-120	120	M10/M12/M14/M16	19	15.6	70.6	13	28	13.6	13.4	3,4	32	52	25,83	50
ONKA-6034	SKP-150	150	M10/M12/M14/M16	21	17	77.6	13	30.6	17.6	16.4	4	30	74	35,38	40
ONKA-6035	SKP-185	185	M10/M12/M14/M16/M20	23	19	85	17	34	17.6	17.4	4	36	92	44,41	30
ONKA-6036	SKP-240	240	M10/M12/M14/M16/M20	26	21	90	17	37.8	17.6	17.4	5	38	133	65,30	25
ONKA-6037	SKP-300	300	M14/M16/M20	28.6	23.5	103	17	42	21.2	14.8	5,1	53	181	98,54	10
ONKA-6038	SKP-400	400	M14/M16/M20	32.8	27	125	17	47.5	24	16	5,8	36	282	139,29	10
ONKA-6039	SKP-500	-	-	-	-	-	-	-	-	-	-	-	-	ʘ	-
ONKA-6040	SKP-600	-	-	-	-	-	-	-	-	-	-	-	-	ʘ	-

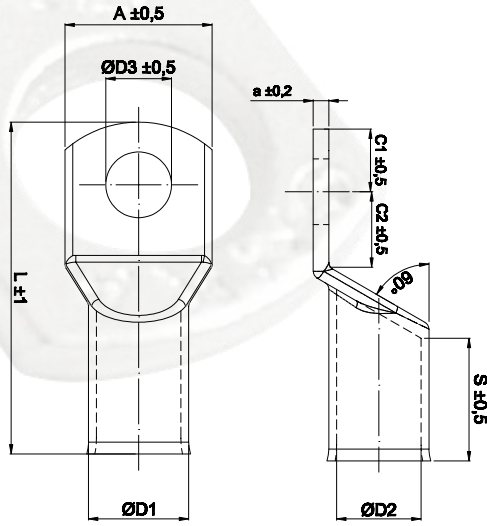
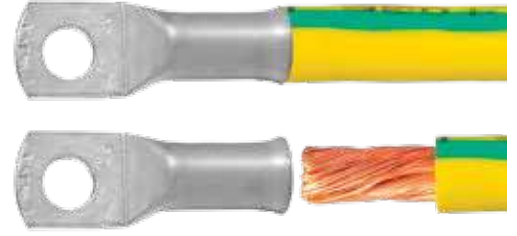
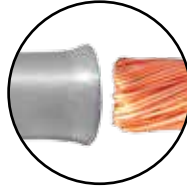

LONG BOY SKP SIKMALI KABLO PAPUÇLARI (BAKIR)

KOD	REF. NO	KAB. KES. mm ²	ÇİVATA	ØD1 (mm)	ØD2 (mm)	L (mm)	ØD3 (mm)	A (mm)	C1 (mm)	C2 (mm)	a (mm)	s (mm)	AĞIRLIK (gr./Ad.)	AD. / ʘ	K.AD
ONKA-6401	SKP-6	6	M5/M6	5.5	4	25.7	5.5	8.5	6	5	1,5	11,5	2	1,33	1500
ONKA-6402	SKP-10	10	M5/M6	6.5	5	27.3	5.5	9.5	5.6	6.4	1,5	13	2,5	1,53	1000
ONKA-6403	SKP-16	16	M6/M8	7	5.5	29.7	6.5	10.5	5.6	6.4	1,5	14,5	3,5	1,92	600
ONKA-6404	SKP-25	25	M6/M8	9	7.5	40	8.5	13	7.3	8.7	1,5	18	6	3,15	300
ONKA-6405	SKP-35	35	M6/M8/M10	10.5	8.5	43.3	8.5	15.5	8.6	9.4	2	20	10	5,21	250
ONKA-6406	SKP-50	50	M8/M10/M12/M14	12	10	51.2	10.5	18	10.5	11	2	22	15	7,09	150
ONKA-6407	SKP-70	70	M8/M10/M12/M14	14	11.5	55	10.5	20.5	10.5	11	2,9	24	23	10,86	100
ONKA-6408	SKP-95	95	M8/M10/M12/M14	16	13.5	59.6	10.5	23.5	10,5	11.5	2,6	28	30	13,97	75
ONKA-6409	SKP-120	120	M10/M12/M14/M16	18	15.5	70.6	13	26.5	13.6	13.4	2,6	28,5	39	19,25	50
ONKA-6410	SKP-150	150	M10/M12/M14/M16	20	16.5	77.6	13	29	17.6	16.4	3,4	31	63	30,75	40
ONKA-6411	SKP-185	185	M10/M12/M14/M16/M20	22	18.5	85	17	32	17.6	17.4	3,5	36	78	37,39	30
ONKA-6412	SKP-240	240	M10/M12/M14/M16/M20	25.5	21.5	90	17	37.5	17.6	17.4	4	41	106	51,87	25

DIN NORMU 46235 TİP SKP SIKMALI KABLO PAPUÇLARI (BAKIR)

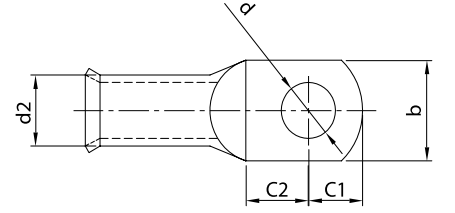
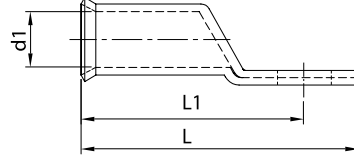

KOD	REF. NO	KAB. KES. mm ²	MET	d mm	d1 mm	d2 mm	L mm	L1 mm	b mm	C1 mm	C2 mm	AĞIRLIK (gr./Ad.)	AD. / ʘ	K. AD.
ONKA-6052	DSKP-10-5	10	M5	5,3	5	6,5	34	27	9	7	8,5	3	1,82	800
ONKA-6053	DSKP-10-6	10	M6	6,4	5	6,5	34,5	27	9	7,5	8,5		1,82	800
ONKA-6054	DSKP-16-6	16	M6	6,4	5,5	8,5	43,5	36	13	7,5	8		6,10	300
ONKA-6055	DSKP-16-8	16	M8	8,4	5,5	8,5	46	36	13	10	10	11	6,10	300
ONKA-6056	DSKP-16-10	16	M10	10,5	5,5	8,5	48	36	17	12	12		6,10	300
ONKA-6057	DSKP-25-6	25	M6	6,6	7	10	45,5	38	14	7,5	8		7,70	250
ONKA-6058	DSKP-25-8	25	M8	8,4	7	10	48	38	16	10	10	13	7,70	250
ONKA-6059	DSKP-25-10	25	M10	10,5	7	10	50	38	17	12	12		7,70	250
ONKA-6106	DSKP-25-12	25	M12	13	7	10	51	38	19	13	13		7,70	250
ONKA-6061	DSKP-35-8	35	M8	8,4	8,2	12,5	52	42	17	10	10		14,96	150
ONKA-6062	DSKP-35-10	35	M10	10,5	8,2	12,5	54	42	19	12	12	29	14,96	150
ONKA-6063	DSKP-35-12	35	M12	13	8,2	12,5	55	42	21	13	13		14,96	150
ONKA-6064	DSKP-50-8	50	M8	8,4	10	14,5	62	52	20	10	10		22,02	75
ONKA-6065	DSKP-50-10	50	M10	10,5	10	14,5	64	52	22	12	12	44	22,02	75
ONKA-6066	DSKP-50-12	50	M12	13	10	14,5	65	52	24	13	13		22,02	75
ONKA-6067	DSKP-50-16	50	M16	17	10	14,5	68	52	28	16	16		22,02	75
ONKA-6068	DSKP-70-8	70	M8	8,4	11,5	16,5	65	55	24	10	10		29,14	75
ONKA-6069	DSKP-70-10	70	M10	10,5	11,5	16,5	68	55	23,8	12	12	62	29,14	75
ONKA-6070	DSKP-70-12	70	M12	13	11,5	16,5	68	55	24	13	13		29,14	75
ONKA-6072	DSKP-70-16	70	M16	17	11,5	16,5	71	55	30	16	16		29,14	75
ONKA-6074	DSKP-95-10	95	M10	10,5	13,5	19	77	65	28	12	12		43,44	40
ONKA-6075	DSKP-95-12	95	M12	13	13,5	19	78,5	64,5	27	14	14	90	43,44	40
ONKA-6077	DSKP-95-16	95	M16	17	13,5	19	81	65	32	16	16		43,44	40
ONKA-6078	DSKP-120-10	120	M10	10,5	15,5	21	85	70	32	15	16		53,65	40
ONKA-6079	DSKP-120-12	120	M12	13	15,5	21	86	69,5	30	16,5	16,5	112	53,65	40
ONKA-6081	DSKP-120-16	120	M16	17	15,5	21	89	70	32	19	20		53,65	40
ONKA-6082	DSKP-120-20	120	M20	21	15,5	21	91	70	39	21	22		53,65	40
ONKA-6083	DSKP-150-10	150	M10	10,5	17	23,5	93	78	34	15	16		76,98	25
ONKA-6084	DSKP-150-12	150	M12	13	17	23,5	94	78	34	16	17	160	76,98	25
ONKA-6086	DSKP-150-16	150	M16	17	17	23,5	97	78	34	19	20		76,98	25
ONKA-6087	DSKP-150-20	150	M20	21	17	23,5	99	78	40	21	22		76,98	25
ONKA-6088	DSKP-185-10	185	M10	10,5	19	25,5	97	82	37	15	16		88,30	20
ONKA-6089	DSKP-185-12	185	M12	13	19	25,5	98	82	37	16	17	188	88,30	20
ONKA-6091	DSKP-185-16	185	M16	17	19	25,5	101	82	37	19	20		88,30	20
ONKA-6092	DSKP-185-20	185	M20	21	19	25,5	103	82	40	21	22		88,30	20
ONKA-6094	DSKP-240-12	240	M12	13	21,5	29	108	92	42	16	17	223	126,89	15
ONKA-6096	DSKP-240-16	240	M16	17	21,5	29	111	92	42	19	20		126,89	15
ONKA-6097	DSKP-240-20	240	M20	21	21,5	29	113	92	45	21	22		126,89	15
ONKA-6098	DSKP-300-14	300	M14	15	24,5	32	119	100	48	19	22			10
ONKA-6099	DSKP-300-16	300	M16	17	24,5	32	119	100	48	19	22			10
ONKA-6100	DSKP-300-20	300	M20	21	24,5	32	119	100	48	19	22			10
ONKA-6101	DSKP-400-14	400	M14	15	27,5	38,5	140	121	55	19	22			10
ONKA-6102	DSKP-400-16	400	M16	17	27,5	38,5	140	121	55	19	22			10
ONKA-6103	DSKP-400-20	400	M20	21	27,5	38,5	140	121	55	19	22			10
ONKA-6104	DSKP-500-20	500	M20	-	-	-	-	-	-	-	-			-
ONKA-6105	DSKP-625-20	625	M20	-	-	-	-	-	-	-	-			-

SKP AÇIK AĞIZLI SIKMALI KABLO PAPUÇLARI



Civataları tam sökmeden kolay montaj imkanı.

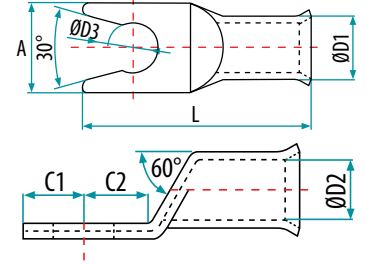

KOD	K. KESİTİ mm ²	CİVATA	ØD1	ØD2	L	ØD3	A	C1	C2	AD. / ʘ	K. AD.
ONKA-6210	10	M5	6.5	5	25	5.5	9.5	5.5	6.5	1,66	1250
ONKA-6211	16	M6	7	5.5	27.5	6.5	10.5	5.5	6.5	1,93	750
ONKA-6212	25	M8	9	7.5	34	8.5	13	7	9	2,86	450
ONKA-6213	35	M8	10.5	8.5	39	8.5	15.5	8.5	9.5	4,84	300
ONKA-6214	50	M8	12	10	47	8.5	18	10	11.5	6,36	175

45° SIKMALI KABLO PABUÇLARI

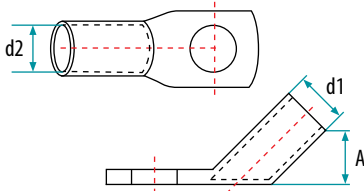

KOD	METRİK (ø)	KESİT	İÇ ÇAP (d1) mm	DIŞ ÇAP (d2) mm	KABLO BOYU (A)	AD. / ʘ	K. AD.
ONKA-6304	M 5	6	4.00	5.50	9.50	1,28	800
ONKA-6305	M 5/6	10	4.50	6.00	11.50	1,28	500
ONKA-6306	M 6/8/10	16	5.50	7.50	12.50	1,80	300
ONKA-6307	M 8/10	25	7.00	9.50	15.50	2,93	200
ONKA-6308	M 8/10	35	8.50	11.00	17.00	3,98	125
ONKA-6309	M 10/12	50	10.00	13.00	18.50	6,45	80
ONKA-6310	M 10/12	70	11.50	14.50	22.00	9,00	60
ONKA-6311	M 10/12/14	95	13.50	16.50	24.00	10,50	40
ONKA-6312	M 10/12/14	120	14.50	18.00	27.00	13,50	30
ONKA-6313	M 10/12/16	150	16.50	21.00	29.00	20,25	25
ONKA-6314	M 10/12/16	185	18.50	23.00	32.00	28,50	20
ONKA-6315	M 10/12/16	240	21.00	26.00	37.00	33,75	15
ONKA-6316	M 12/16	300	23.50	28.50	39.00	33,75	8

90° SIKMALI KABLO PABUÇLARI

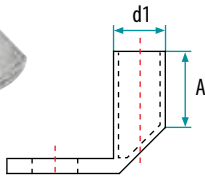
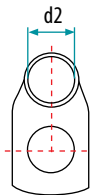
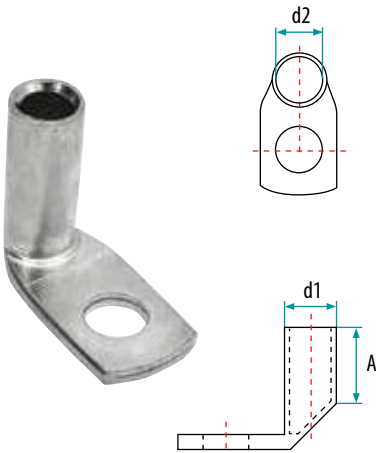

KOD	METRİK (ø)	KESİT	İÇ ÇAP (d1) mm	DIŞ ÇAP (d2) mm	KABLO BOYU (A)	AD. / ʘ	K. AD.
ONKA-6319	M 5	6	4.00	5.50	9.50	1,28	800
ONKA-6320	M 5/6	10	4.50	6.00	11.50	1,28	500
ONKA-6321	M 6/8/10	16	5.50	7.50	12.50	1,80	300
ONKA-6322	M 8/10	25	7.00	9.50	15.50	2,93	200
ONKA-6323	M 8/10	35	8.50	11.00	17.00	3,98	150
ONKA-6324	M 10/12	50	10.00	13.00	18.50	6,45	80
ONKA-6325	M 10/12	70	11.50	14.50	22.00	9,00	60
ONKA-6326	M 10/12/14	95	13.50	16.50	24.00	10,50	50
ONKA-6327	M 10/12/14	120	14.50	18.00	27.00	13,50	30
ONKA-6328	M 10/12/16	150	16.50	21.00	29.00	20,25	25
ONKA-6329	M 10/12/16	185	18.50	23.00	32.00	28,50	20
ONKA-6330	M 10/12/16	240	21.00	26.00	37.00	33,75	15
ONKA-6331	M 12/16	300	23.50	28.50	39.00	1,28	8

KAYNAKLI TİP SKP

DIN 46234 Standartı,
Bakır Malzemeden
Kalay Kaplı



KOD	KABLO KESİTİ	METRİK ÖLÇÜSÜ (d2)	d ₁	l ₁	b	l ₂	d ₂	AD. / ʘ	K. AD.
ONKA-102002	0.5 - 1 mm ²	M3	1.6	10.8	6.0	4.8	3,2	0,438	1000
ONKA-102004	0.5 - 1 mm ²	M3.5	1.6	10.8	6.0	4.8	3,7	0,438	1000
ONKA-102006	0.5 - 1 mm ²	M4	1.6	11.8	8.0	4.8	4,3	0,507	1000
ONKA-102008	0.5 - 1 mm ²	M5	1.6	12.8	10.0	4.8	5,3	0,585	1000
ONKA-102010	0.5 - 1 mm ²	M6	1.6	14.8	11.0	4.8	6,5	0,681	1000
ONKA-102011	0.5 - 1 mm ²	M8	1.6	17.0	14.0	4.8	8,4	0,75	1000
ONKA-102012	1.5 - 2.5 mm ²	M3	2.3	10.8	6.0	4.8	3,2	0,438	1000
ONKA-102014	1.5 - 2.5 mm ²	M3.5	2.3	10.8	6.0	4.8	3,7	0,438	1000
ONKA-102016	1.5 - 2.5 mm ²	M4	2.3	11.8	8.0	4.8	4,3	0,507	1000
ONKA-102018	1.5 - 2.5 mm ²	M5	2.3	13.8	10.0	4.8	5,3	0,585	1000
ONKA-102020	1.5 - 2.5 mm ²	M6	2.3	15.8	11.0	4.8	6,5	0,681	1000
ONKA-102022	1.5 - 2.5 mm ²	M8	2.3	16.8	14.0	4.8	8,4	0,936	1000
ONKA-102023	1.5 - 2.5 mm ²	M10	2.3	17.0	15.0	4.8	10,5	1,17	1000
ONKA-102024	4 - 6 mm ²	M4	3.6	14.0	8.0	6.0	4,3	1,053	100
ONKA-102026	4 - 6 mm ²	M5	3.6	15.0	10.0	6.0	5,3	1,053	100
ONKA-102028	4 - 6 mm ²	M6	3.6	16.0	11.0	6.0	6,5	1,071	100
ONKA-102030	4 - 6 mm ²	M8	3.6	19.0	14.0	6.0	8,4	1,404	100
ONKA-102032	4 - 6 mm ²	M10	3.6	21.0	18.0	6.0	10,5	1,638	100
ONKA-102033	4 - 6 mm ²	M12	3.6	21.0	18.0	6.0	13,0	1,872	100
ONKA-102036	10 mm ²	M5	4.5	16.0	10.0	8.0	5,3	1,755	100
ONKA-102038	10 mm ²	M6	4.5	17.0	11.0	8.0	6,5	1,755	100
ONKA-102040	10 mm ²	M8	4.5	20.0	14.0	8.0	8,4	2,106	100
ONKA-102042	10 mm ²	M10	4.5	21.0	18.0	8.0	10,5	2,55	100
ONKA-102044	10 mm ²	M12	4.5	23.0	22.0	8.0	13,0	2,67	100
ONKA-102046	16 mm ²	M5	5.8	20.0	11.0	10.0	5,3	2,808	100
ONKA-102048	16 mm ²	M6	5.8	20.0	11.0	10.0	6,5	2,808	100
ONKA-102050	16 mm ²	M8	5.8	22.0	14.0	10.0	8,4	3,042	100
ONKA-102052	16 mm ²	M10	5.8	24.0	18.0	10.0	10,5	3,45	100
ONKA-102054	16 mm ²	M12	5.8	26.0	22.0	10.0	13,0	3,861	100
ONKA-102056	25 mm ²	M5	7.5	25.0	12.0	11.0	5,3	4,446	100
ONKA-102058	25 mm ²	M6	7.5	25.0	12.0	11.0	6,5	4,446	100
ONKA-102060	25 mm ²	M8	7.5	25.0	16.0	11.0	8,4	4,446	100
ONKA-102062	25 mm ²	M10	7.5	26.0	18.0	11.0	10,5	5,031	100
ONKA-102064	25 mm ²	M12	7.5	31.0	22.0	11.0	13,0	6,33	100
ONKA-102068	25 mm ²	M16	7.5	35.0	28.0	11.0	17,0	7,29	100
ONKA-102070	35 mm ²	M6	9.0	26.0	15.0	12.0	6,5	6,3	100
ONKA-102072	35 mm ²	M8	9.0	26.0	16.0	12.0	8,4	6,66	100
ONKA-102074	35 mm ²	M10	9.0	27.0	18.0	12.0	10,5	7,02	100
ONKA-102076	35 mm ²	M12	9.0	31.0	22.0	12.0	13,0	7,95	100
ONKA-102080	35 mm ²	M16	9.0	35.0	28.0	12.0	17,0	9,36	100
ONKA-102082	50 mm ²	M6	11.0	34.0	18.0	16.0	6,5	11,22	100
ONKA-102084	50 mm ²	M8	11.0	34.0	18.0	16.0	8,4	11,22	100
ONKA-102086	50 mm ²	M10	11.0	34.0	18.0	16.0	10,5	11,22	100
ONKA-102088	50 mm ²	M12	11.0	36.0	22.0	16.0	13,0	11,94	100
ONKA-102092	50 mm ²	M16	11.0	40.0	22.0	16.0	17,0	16,14	100
ONKA-102093	70 mm ²	M6	15.0	38.0	22.0	18.0	6,5	15,795	100
ONKA-102094	70 mm ²	M8	15.0	38.0	22.0	18.0	8,4	15,795	100
ONKA-102096	70 mm ²	M10	15.0	38.0	22.0	18.0	10,5	15,795	100
ONKA-102098	70 mm ²	M12	15.0	38.0	22.0	18.0	13,0	15,9	100
ONKA-102102	70 mm ²	M16	15.0	42.0	28.0	18.0	17,0	16,59	100
ONKA-102103	95 mm ²	M8	15.0	42.0	24.0	20.0	8,4	23,4	100
ONKA-102104	95 mm ²	M10	15.0	42.0	24.0	20.0	10,5	22,92	100
ONKA-102106	95 mm ²	M12	15.0	42.0	24.0	20.0	13,0	22,92	100
ONKA-102110	95 mm ²	M16	15.0	44.0	28.0	20.0	17,0	22,92	100
ONKA-102111	120 mm ²	M8	16.5	44.0	24.0	22.0	8,4	30,42	50
ONKA-102112	120 mm ²	M10	16.5	44.0	24.0	22.0	10,5	30,42	50
ONKA-102114	120 mm ²	M12	16.5	44.0	24.0	22.0	13,0	30,42	50
ONKA-102118	120 mm ²	M16	16.5	48.0	28.0	22.0	17,0	37,44	50
ONKA-102120	150 mm ²	M10	19.0	50.0	30.0	24.0	10,5	50,7	50
ONKA-102123	150 mm ²	M12	19.0	50.0	30.0	24.0	13,0	50,7	50
ONKA-102126	150 mm ²	M16	19.0	50.0	30.0	24.0	17,0	50,7	50
ONKA-102128	185 mm ²	M12	21.0	50.0	36.0	28.0	13,0	71,16	50
ONKA-102132	185 mm ²	M16	21.0	50.0	36.0	28.0	17,0	71,16	50
ONKA-102134	240 mm ²	M12	23.5	56.0	38.0	32.0	13,0	92,64	50
ONKA-102138	240 mm ²	M16	23.5	56.0	38.0	32.0	17,0	92,64	50

ALÜMİNYUM DIN NORMU SKP SIKMALI KABLO PAPUÇLARI

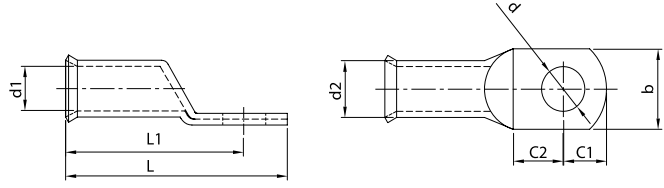

KOD	REF. NO	KABLO KESİTİ mm ²	ÇİVATA	D (mm)	D1 (mm)	D2 (mm)	L (mm)	L1 (mm)	B (mm)	C1 (mm)	C2 (mm)	a (mm)	s (mm)	AD. / ʘ	K. AD.
ONKA-6122	DSKP-10	10 mm ²	M6	5,5	5	8	50	43	9	7	8,5	3,2	30	1,87	300
ONKA-6123	DSKP-16	16 mm ²	M6	8,4	6	10	53	43	13	10	10	3,7	30	2,64	200
ONKA-6124	DSKP-25	25 mm ²	M8	8,4	7	12	62	52	16	10	10	5	36	3,42	100
ONKA-6125	DSKP-35	35 mm ²	M10	10,5	8,2	14	70	58	19	12	12	5	46	4,73	75
ONKA-6126	DSKP-50	50 mm ²	M10	10,5	10	16	80	68	22	12	12	6,3	47	6,08	70
ONKA-6127	DSKP-70	70 mm ²	M10	10,5	12	18	90	78	24	12	12	6,2	53	7,85	40
ONKA-6128	DSKP-95	95 mm ²	M12	13	13,4	22	95	82	28	13	13	8	55	12,98	25
ONKA-6129	DSKP-120	120 mm ²	M12	13	15	23	110	94	32	16	17	6,4	61	14,60	20
ONKA-6130	DSKP-150	150 mm ²	M14	13	16,5	26	114	98	34	16	17	9	63	19,47	15
ONKA-6131	DSKP-185	185 mm ²	M14	13	18,5	28	125	109	37	16	17	8	63	23,28	10
ONKA-6132	DSKP-240	240 mm ²	M14	13	32	20	140	124	42	16	17	10	79	32,05	8

ALÜMİNYUM DIN NORMU SKP SIKMALI KABLO PAPUÇLARI (TAPALI, YAĞLI)



TAPALI VE YAĞLI

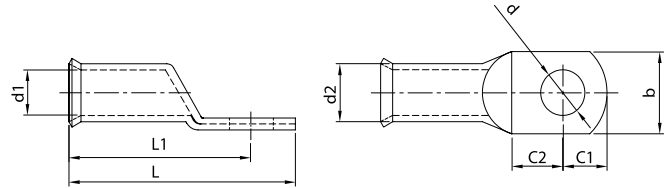
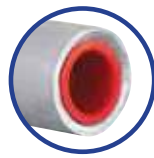

KOD	REF. NO	KABLO KESİTİ mm ²	ÇİVATA	d mm	d1 mm	d2 mm	L mm	L1 mm	b mm	C1 mm	C2 mm	AD. / ʘ	K. AD.
ONKA-6237	DSKP-10	10	M5	5,3	5,0	8,0	50,0	43,0	9,0	7,0	8,5	3,69	300
ONKA-6238	DSKP-16	16	M8	8,4	6,0	10,0	53,0	43,0	13,0	10,0	10,0	4,51	200
ONKA-6239	DSKP-25	25	M8	8,4	7,0	12,0	62,0	52,0	16,0	10,0	10,0	6,10	100
ONKA-6240	DSKP-35	35	M10	10,5	8,2	14,0	70,0	58,0	19,0	12,0	12,0	8,01	75
ONKA-6241	DSKP-50	50	M10	10,5	10,0	16,0	80,0	68,0	22,0	12,0	12,0	10,06	70
ONKA-6242	DSKP-70	70	M10	10,5	12,0	18,0	90,0	78,0	24,0	12,0	12,0	12,63	40
ONKA-6243	DSKP-95	95	M12	13,0	13,4	22,0	95,0	82,0	28,0	13,0	13,0	20,89	25
ONKA-6244	DSKP-120	120	M12	13,0	15,0	23,0	110,0	94,0	32,0	16,0	17,0	23,88	25
ONKA-6245	DSKP-150	150	M12	13,0	16,5	26,0	114,0	98,0	34,0	16,0	17,0	32,19	15
ONKA-6246	DSKP-185	185	M12	13,0	18,5	28,0	125,0	109,0	37,0	16,0	17,0	38,88	10
ONKA-6247	DSKP-240	240	M12	13,0	20,0	32,0	140,0	124,0	42,0	16,0	17,0	58,10	8



BAKIR ALÜMİNYUMLU SKP (Bimetalik)

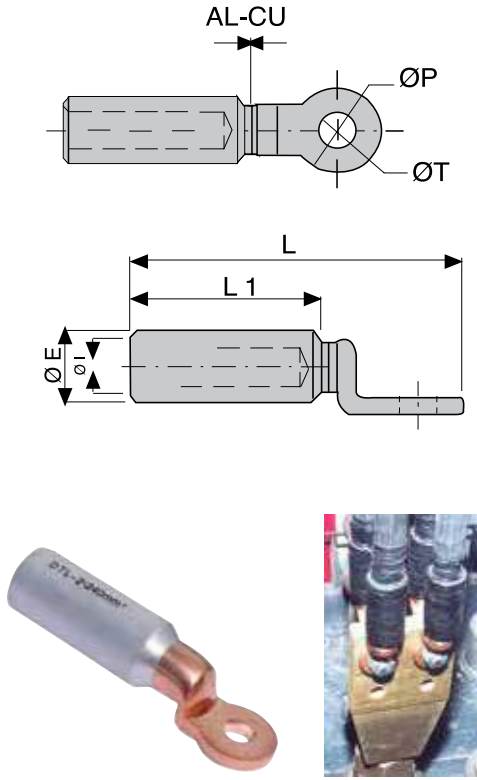

KOD	REF. NO	K. KESİTİ mm ²	ØE	Øİ	L	ØT	L1	AD. / \$	K. AD.
ONKA-6108	TBF-16	16 mm ²	20	6,5	84	12,8	46	2,80 \$	30
ONKA-6109	TBF-25	25 mm ²	20	6,5	84	12,8	46	2,80 \$	30
ONKA-6110	TBF-35	35 mm ²	20	8	84	12,8	46	2,80 \$	30
ONKA-6111	TBF-50	50 mm ²	20	9	84	12,8	46	3,30 \$	30
ONKA-6112	TBF-70	70 mm ²	20	11	84	12,8	46	3,30 \$	30
ONKA-6113	TBF-95	95 mm ²	20	12,5	84	12,8	46	3,30 \$	30
ONKA-6114	TBF-120	120 mm ²	25	13,7	107	12,8	62,5	5,80 \$	30
ONKA-6115	TBF-150	150 mm ²	25	15,5	107	12,8	62,5	5,80 \$	30
ONKA-6116	TBF-185	185 mm ²	32	17	117	14,5	64	9,20 \$	30
ONKA-6117	TBF-240	240 mm ²	32	19,5	117	14,5	64	9,20 \$	15
ONKA-6118	TBF-300	300 mm ²	36	23,3	157	16,3	90	16,00 \$	15
ONKA-6119	TBF-400	400 mm ²	36	26	157	16,3	90	16,00 \$	10

BAKIR ALÜMİNYUMLU SKP (Bimetalik Uzun Tip)

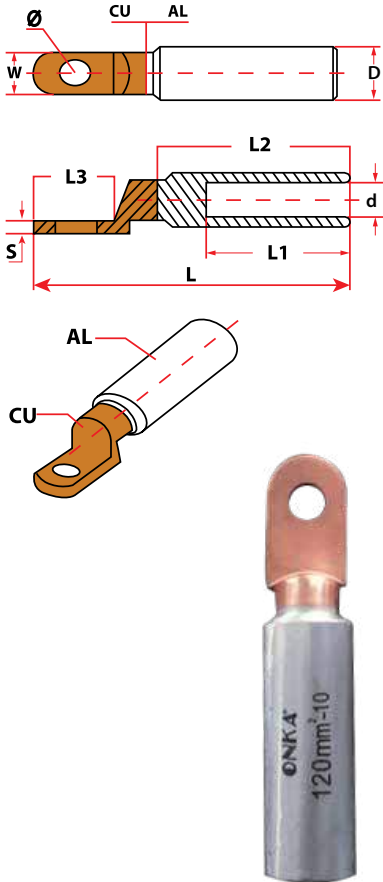

KOD	REF. NO	K. KESİTİ mm ²	D	d	L±1	L1	L2	L3	W	Q	S	AD. / \$	K. AD.
ONKA-6510	CAL-M16	16 mm ²	16	5,5	82	38	50	23	14,0	8,5	3,2	2,60 \$	30
ONKA-6511	CAL-M25	25 mm ²	16	6,5	82	38	50	23	14,0	8,5	3,2	2,60 \$	30
ONKA-6512	CAL-M35	35 mm ²	16	8,2	82	38	50	23	14,0	8,5	3,2	2,60 \$	30
ONKA-6513	CAL-M50	50 mm ²	20	9,7	94	43	55	27	16,0	8,5	5,2	3,60 \$	30
ONKA-6514	CAL-M70	70 mm ²	20	11	94	43	55	27	16,0	8,5	5,2	3,60 \$	30
ONKA-6515	CAL-M95	95 mm ²	20	12,5	94	43	55	27	16,0	8,5	5,2	3,60 \$	30
ONKA-6516	CAL-M120	120 mm ²	25	14,5	120	60	72	32	23,0	10,5	6,5	6,20 \$	30
ONKA-6517	CAL-M150	150 mm ²	25	16,5	120	60	72	32	23,0	10,5	6,5	6,20 \$	30
ONKA-6518	CAL-M185	185 mm ²	32	17,5	133	60	73	38	23,0	12,5	8	10,40 \$	30
ONKA-6519	CAL-M240	240 mm ²	32	19,5	133	60	73	38	29,0	12,5	8	10,40 \$	15
ONKA-6520	CAL-M300	300 mm ²	34	23	133	61	73	35	29,0	12,5	8,5	12,00 \$	-
ONKA-6521	CAL-M400	400 mm ²	40	26,2	163	93	105	35	29,0	12,5	10,5	18,50 \$	-
ONKA-6522	CAL-M500	500 mm ²	40	29	163	93	105	35	29,0	12,5	10,5	18,50 \$	-

ALÜMİNYUM-BAKIR EK MUF

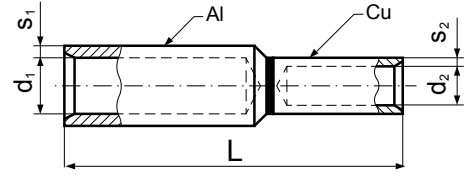

KOD	AL KABLO KESİTİ	CU KABLO KESİTİ	d1	d2	l	AD. / \$	K. AD.
ONKA - 6351	35 mm ²	16 mm ²	8.0	5.5	71.0	1,60 \$	1
ONKA - 6352	50 mm ²	25 mm ²	9.8	5.5	71.5	2,10 \$	1
ONKA - 6353	70 mm ²	35 mm ²	11.2	5.5	79.0	2,80 \$	1
ONKA - 6354	95 mm ²	50 mm ²	13.2	5.5	79.0	4,10 \$	1
ONKA - 6355	120 mm ²	70 mm ²	14.7	5.5	87.0	4,60 \$	1
ONKA - 6356	150 mm ²	95 mm ²	16.3	5.5	93.3	5,40 \$	1
ONKA - 6357	185 mm ²	120 mm ²	18.3	10.0	108.0	7,20 \$	1
ONKA - 6358	240 mm ²	150 mm ²	21.0	10.0	116.0	10,10 \$	1

ALÜMİNYUM-BAKIR EK MUF (PİNLİ)

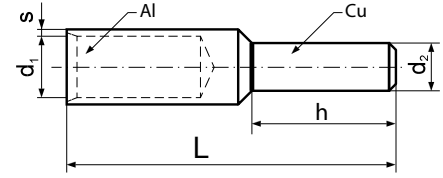

KOD	KABLO KESİTİ		ØD1	ØD2	L		AD. / \$	K. AD.
	Çok Telli Kablo	Tek Damar Kablo	D1	D2	l	h		
ONKA - ???	10	16	12	5	58	15	2,00 \$	1
ONKA - ???	16	25	12	6	58	15	2,00 \$	1
ONKA - 6335	25	35	6.8	6	58	20	2,00 \$	1
ONKA - 6336	35	50	8.0	7	71	22	2,35 \$	1
ONKA - 6337	50	70	9.8	8	74	25	2,70 \$	1
ONKA - 6338	70	95	11.2	10	87	30	2,80 \$	1
ONKA - 6339	95	120	13.2	12	91	33	4,00 \$	1
ONKA - 6340	120	150	14.7	12	97	38	5,00 \$	1
ONKA - 6341	150	185	16.3	12	108	38	5,20 \$	1
ONKA - 6342	185	240	18.3	14	116	44	6,95 \$	1
ONKA - 6343	240	300	21.0	16	128	44	7,80 \$	1
ONKA - 6344	300	-	23.3	18	131	46	9,20 \$	1

KJB TİP BİMETALİK ALÜMİNYUM-BAKIR BAĞLANTI ELEMANI

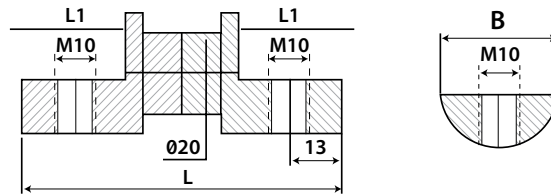

KOD	REF. NO	L (mm)	L1 (mm)	B (mm)	BOLT DIAMETER	AD. / \$	K. AD.
ONKA - 6530	KJB-26	80	26	26	M 10	13,20 \$	
ONKA - 6531	KJB-29	80	26	29	M 10	15,20 \$	

BİMETAL MEKANİK SIKMALI KABLO PAPUCU



KOD	K. KESİTİ	DIŞ ÇAP	VİDA SAYISI	UYGUN ANAHTAR	AD. / ƒ	K. /AD.
BMSKP 35-150-12/2	35 - 150	28	2	17		80
BMSKP 70-240-12/2	70 - 240	33	2	19		40
BMSKP 120-300-12/2	120-300	38	2	22		36
BMSKP 185-400-16/2	185-400	42	2	22		28

MEKANİK SIKMALI KABLO PAPUCU (ALÜMİNYUM)



KOD	K. KESİTİ	DIŞ ÇAP	VİDA SAYISI	UYGUN ANAHTAR	AD. / ƒ	K. /AD.
MSKP 35-150-12/2	35 - 150	28	2	17		20
MSKP 70-240-12/2	70 - 240	33	2	19		12
MSKP 120-300-16/2	120-300	38	2	22		9
MSKP 185-400-16/2	185-400	42	2	22		7

MEKANİK SIKMALI EK MUF (ALÜMİNYUM)



KOD	K. KESİTİ	DIŞ ÇAP	VİDA SAYISI	UYGUN ANAHTAR	AD. / ƒ	K. /AD.
MSEM 35-150/4	35 - 150	28	4	17		20
MSEM 70-240/4	70 - 240	33	4	19		15
MSEM 120-300/4	120-300	38	4	22		10
MSEM 185-400/4	185-400	42	4	22		9
MSEM 500-630/6	400-630	52	6	24		4



Kod	mm ² AL Daire İletken / Al	mm ² AL Dilim İletken	mm ² Cu Daire İletken / Cu	mm ² Cu Dilim İletken	mm ² Soyma Boyu	L mm İlave Çap Büyütücü	İlave Parçasız	Cıvata Çapı	Cıvata Çapı
SKP 35-150-12/2	35-150	35-150	35-120	35-150	35-120	41	35-70	95-150	17
SKP 70-240-12/2	70-240	70-240	70-185	70-240	70-185	64	70-120	150-240	19
SKP 120-300-16/2	120-300	120-300	120-240	120-300	120-240	71	120-185	240-300	22
SKP 185-400-16/2	185-400	185-400	185-300	185-400	185-300	81	185-240	300-400	22

BAKIR STANDART SIKMALI EK MUFLAR

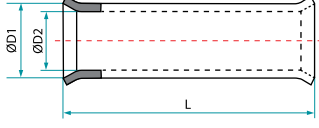

KOD	CİNSİ	K. KESİTİ	ØD1	ØD2	L	AD. / ʘ	K. AD.
ONKA - 6141	SEM-10	10 mm ²	6.5	5	25.5	2,14	750
ONKA - 6142	SEM-16	16 mm ²	7	5.5	28	2,28	500
ONKA - 6143	SEM-25	25 mm ²	9	7.5	34.5	3,38	300
ONKA - 6144	SEM-35	35 mm ²	10.5	8.5	39.5	5,67	200
ONKA - 6145	SEM-50	50 mm ²	12	10	47.5	7,63	150
ONKA - 6146	SEM-70	70 mm ²	14	11.5	49.5	11,21	100
ONKA - 6147	SEM-95	95 mm ²	16	13.5	53.5	13,85	75
ONKA - 6148	SEM-120	120 mm ²	18	15.5	64	19,38	50
ONKA - 6149	SEM-150	150 mm ²	20	16.5	71.5	31,46	35
ONKA - 6150	SEM-185	185 mm ²	22	18.5	77.5	37,13	25
ONKA - 6151	SEM-240	240 mm ²	25.5	21.5	83.5	54,27	20

EKSTRA STANDART UZUN ve KALIN TİP SIKMALI EK MUFLAR (BAKIR)

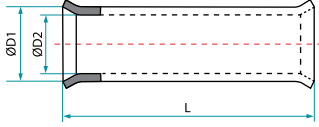

KOD	CİNSİ	K. KESİTİ	ØE	Øİ	L	AD. / ʘ	K. AD.
ONKA - 6160	SEM-6	6 mm ²	5.5	4	26.5	1,90	1000
ONKA - 6161	SEM-10	10 mm ²	6.5	5	28	2,15	750
ONKA - 6162	SEM-16	16 mm ²	7.8	5.8	30.5	3,41	500
ONKA - 6163	SEM-25	25 mm ²	9.5	7.2	40.5	5,87	400
ONKA - 6164	SEM-35	35 mm ²	10.8	8.5	44	8,28	250
ONKA - 6165	SEM-50	50 mm ²	13	10	52	12,84	150
ONKA - 6166	SEM-70	70 mm ²	14.7	11.5	55.5	17,53	100
ONKA - 6167	SEM-95	95 mm ²	16.7	13.5	59.5	20,75	75
ONKA - 6168	SEM-120	120 mm ²	19	15.6	70.5	28,05	50
ONKA - 6169	SEM-150	150 mm ²	21	17	77.5	38,15	35
ONKA - 6170	SEM-185	185 mm ²	23	19	85.5	47,17	25
ONKA - 6171	SEM-240	240 mm ²	26	21	90.5	73,29	20
ONKA - 6172	SEM-300	300 mm ²	28.6	23.5	103	111,12	12
ONKA - 6173	SEM-400	400 mm ²	32.8	27	113	159,25	10
ONKA - 6174	SEM-500	500 mm ²				ʘ	10
ONKA - 6175	SEM-600	600 mm ²				ʘ	10

DIN NORMU 46235 TİP SIKMALI EK MUFLAR (BAKIR)

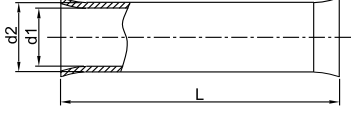

KOD	CİNSİ	K. KESİTİ	Ød1	Ød2	L	AD. / ı	K. AD.
ONKA - 6181	SEM-10	10 mm ²	6,5	5	30	2,50	400
ONKA - 6182	SEM-16	16 mm ²	8,5	5,5	50	8,18	250
ONKA - 6183	SEM-25	25 mm ²	10,0	7,0	50	9,80	250
ONKA - 6184	SEM-35	35 mm ²	12,5	8,2	50	16,56	100
ONKA - 6185	SEM-50	50 mm ²	14,5	10,0	56	22,61	100
ONKA - 6186	SEM-70	70 mm ²	16,5	11,5	56	28,67	50
ONKA - 6187	SEM-95	95 mm ²	19,0	13,5	70	44,91	50
ONKA - 6188	SEM-120	120 mm ²	21,0	15,5	70	50,39	50
ONKA - 6189	SEM-150	150 mm ²	23,5	17,0	80	75,90	20
ONKA - 6190	SEM-185	185 mm ²	25,5	19,0	85	88,08	20
ONKA - 6191	SEM-240	240 mm ²	29,0	21,5	90	122,26	10
ONKA - 6192	SEM-300	300 mm ²	-	-	-	⊗	10
ONKA - 6193	SEM-400	400 mm ²	-	-	-	⊗	10
ONKA - 6194	SEM-500	500 mm ²	-	-	-	⊗	10
ONKA - 6195	SEM-625	625 mm ²	-	-	-	⊗	10

ALÜMİNYUM DIN NORMU SIKMALI EK MUFLAR

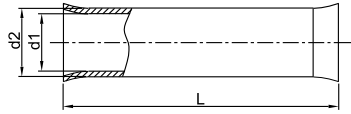

KOD	K. KESİTİ	d1	d2	L	AD. / ı	K. /AD.
ONKA - 6270	DEM-10 mm ²	8,0	5,0	52,0	1,68	300
ONKA - 6271	DEM-16 mm ²	10,0	6,0	55,0	2,30	250
ONKA - 6272	DEM-25 mm ²	12,0	7,0	64,0	3,43	150
ONKA - 6273	DEM-35 mm ²	14,0	8,2	72,0	4,87	100
ONKA - 6274	DEM-50 mm ²	16,0	10,0	82,0	6,52	75
ONKA - 6275	DEM-70 mm ²	18,0	12,0	92,0	8,14	40
ONKA - 6276	DEM-95 mm ²	22,0	13,4	97,0	14,06	20
ONKA - 6277	DEM-120 mm ²	23,0	15,0	112,0	16,43	15
ONKA - 6278	DEM-150 mm ²	26,0	16,5	116,0	23,56	8
ONKA - 6279	DEM-185 mm ²	28,0	18,5	127,0	27,69	7
ONKA - 6280	DEM-240 mm ²	32,0	20,0	142,0	42,04	5

U KLEMENSLER



İzolasyon kapağı ürün ile birlikte verilmektedir.

KOD	KABLO KESİTİ	VİDA	A	t	B	C	D1	D2	E	F	G	AD. / ʘ	K. AD.
ONKA-7050	6 mm ²	Çelik	8,5	1,8	13	19	M6	-	-	-	-	ʘ	300
ONKA-7051	10mm ²	Çelik	10	2,2	15	21	M8	-	-	-	-		250
ONKA-7052	16mm ²	Çelik	12,2	2,3	18,2	28	M10	-	-	-	-		150
ONKA-7053	25mm ²	Çelik	13,8	2,5	20	30,5	7/6"	M5	6	2,25	12		100
ONKA-7054	35mm ²	Çelik	14,5	2,5	23,2	32,5	M12	M5	6	2,25	13,3		75
ONKA-7055	50mm ²	Pirinç	16,2	3	25,4	39	M14	M5	6	2,75	16,6		50
ONKA-7056	70mm ²	Pirinç	19,5	3,25	28,2	43,1	M16	M5	6	4,1	18,5		40
ONKA-7057	95mm ²	Pirinç	21,6	3,25	31,9	45,5	M18	M6	6,5	3,5	19,5		30
ONKA-7058	120mm ²	Pirinç	23,5	3,4	34	50,8	M20	M6	6,5	4	22,15		20
ONKA-7059	150mm ²	Pirinç	28	4,4	39,1	53,9	M22	M6	7	4,4	23,45		10
ONKA-7060	U K. Kay.												100

TIRNAKLI KLEMENSLER



KOD	cinsi	A	B	L	M	AA	C	AD. / ʘ	K. AD.
ONKA-7070	No. 1 16 mm ²	25	22	17,2	M6	10	-	ʘ	500
ONKA-7071	No. 2 25 mm ²	25	26	20,2	M6	10	-		250
ONKA-7072	No. 3 35 mm ²	25	28	30,3	M6	10	15		100
ONKA-7073	No. 4 50 mm ²	25	33	32,4	M6	10	15		100
ONKA-7074	No. 5 70 mm ²	35	40	35,4	M8	13	17		100
ONKA-7075	No. 6-7 120 mm ²	35	49	45,1	M6	13	24		50

KONDANSATÖR KLEMENSLERİ



KOD	cinsi	METRİK	A x B	D	AD. / ʘ	K. AD.
ONKA-7094	Kondansatör Klemensi	M12 (Ø12,3)	25,5 x 39,2 mm	10 mm	ʘ	100
ONKA-7095	Kondansatör Klemensi	M16 (Ø16,3)	30 x 43,3 mm	9,4 mm		80
ONKA-7096	Kondansatör Klemensi	M14 (Ø14,5)	25,5 x 39,2 mm	10 mm		100
ONKA-7097	Kondansatör Klemensi	M14 (Ø14,5)	30 x 43,3 mm	9,4 mm		80
ONKA-7098	Kondansatör Klemensi	M12 (Ø12,3)	30 x 43,3 mm	9,4 mm		80

H KLEMENSLER



KOD	cinsi	SIKMA SAHASI (mm)	KULLANILACĞI İLETKENLER	AD. / ʘ	K. AD.
ONKA - 7068	H16-25-35-50 70-95-120	30	22	ʘ	50

C KLEMENSLER



KOD	cinsi	SIKMA SAHASI (mm)	KULLANILACĞI İLETKENLER	AD. / ʘ	K. AD.
ONKA-7061	CK01 16 - 25	18	16	ʘ	50
ONKA-7062	CK02 25 - 35	27	20		50
ONKA-7063	CK03 35 - 50	32	25		50
ONKA-7064	CK04 50 - 70	41	30		50
ONKA-7065	CK05 70 - 95	45	35		50
ONKA-7066	CK06 95 - 120	60	40		50
ONKA-7067	CK07 120 - 150	65	45		50

AL - CU KLEMENSLER



KOD	CİNSİ	SIKMA SAHASI (mm ²)	KULLANILACAĞI İLETKENLER	AD. / ʈ	K. AD.
ONKA - 7001	A 25 - B 16 AL-CU Klm.	6 - 25 Al / 25 - 16 Cu	Rose	Ⓢ	100
ONKA - 7002	A 40 - B 25 AL-CU Klm.	16 - 40 Al / 10 - 25 Cu	Rose, Lily, Swallow, Sparrow		100
ONKA - 7003	A 70 - B 50 AL-CU Klm.	16 - 70 Al / 10 - 50 Cu	Rose, Lily, Swallow, Sparrow		50
ONKA - 7004	A 120 - B 50 AL-CU Klm.	70 - 120 Al / 10 - 50 Cu	Pannsey, Aster, Pholx, Oxlip Raven, Pigeon		50
ONKA - 7005	A 120 - B 70 AL-CU Klm.	70 - 120 Al / 10 - 70 Cu	Pannsey, Aster, Pholx, Oxlip Raven, Pigeon		50
ONKA - 7006	A 240 - B 120 AL-CU Klm.	70 - 240 Al / 50 - 120 Cu	Daisy, Peony, Tulip, Canna Patridge, Ostrich, Hawk		25
ONKA - 7007	A 240 - B 240 AL-CU Klm.	240 Al / 240 Cu	Daisy, Peony, Tulip, Canna Patridge, Ostrich, Hawk		25

BRANŞMAN KLEMENSLER



KOD	CİNSİ	SIKMA SAHASI (mm ²)	KULLANILACAĞI İLETKENLER	AD. / ʈ	K. AD.
ONKA - 7020	A16-16 Braşman Klm.	6 - 16 Al	Rose	Ⓢ	100
ONKA - 7021	A25-25 Braşman Klm.	6 - 25 Al	Rose		100
ONKA - 7022	A40-40 Braşman Klm.	16 - 40 Al	Rose, Lily, Swallow, Sparrow		100
ONKA - 7023	A70-70 Braşman Klm.	16 - 70 Al	Rose, Lily, Pansy, Swallow, Sparrow		50
ONKA - 7024	A95-95 Braşman Klm.	25 - 95 Al	Lily, Pansy, Swallow, Aster, Rawen		50
ONKA - 7025	A120-120 Braşman Klm.	40 - 120 Al	Pannsey, Aster, Pholx, Oxlip Swallow, robinone, Rawen		50
ONKA - 7026	A150-150 Braşman Klm.	40 - 150 Al	Pannsey, Aster, Pholx, Oxlip Swallow, robinone, Rawen		25
ONKA - 7027	A240-240 Braşman Klm.	40 - 240 Al	Daisy, Peony, Tulip, Canna Patridge, Ostrich, Hawk	25	
ONKA - 7028	Klemens Kapağı		A70-A70/A70-B50		100

DURDURUCU KLEMENSLER



KOD	CİNSİ	SIKMA SAHASI (mm ²)	KULLANILACAĞI İLETKENLER	AD. / ʈ	K. AD.
ONKA - 7040	A16-A50 Durdurucu Klm.	16 - 50 Al	Rose, Lily, Swallow, Sparrow, Swallow	Ⓢ	50
ONKA - 7041	A50-A95 Durdurucu Klm.	50 - 95 Al	Popy, Aster, Pholx, Raven, Rabinone		50
ONKA - 7042	A95-A120 Durdurucu Klm.	95 - 120 Al	Popy, Aster, Pholx, Raven, Rabinone		50

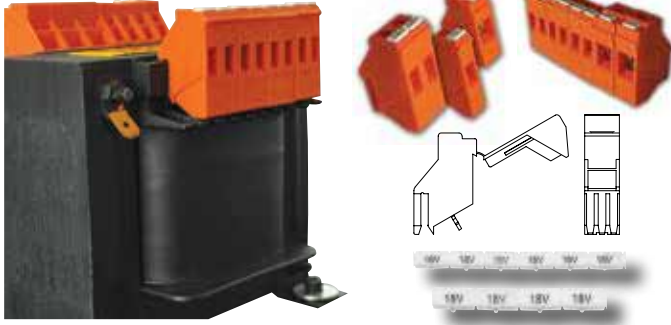

KOD	CİNSİ	AKIM	GERİLİM	AD. / ʘ	K. AD.
ONKA - 5135	1 x 4 mm ² Yüksek Tip	24 A	400 V	Ⓢ	200
ONKA - 5136	2x 4 mm ² Yüksek Tip	24 A	400 V	Ⓢ	100
ONKA - 5137	1 x 6mm ² Yüksek Tip	41 A	400 V	Ⓢ	100
ONKA - 5139	Trafo Klemens Etik. Yazısız			0,21	500
ONKA - 5140	Trafo Klemens Etik. Yazılı			0,45	500

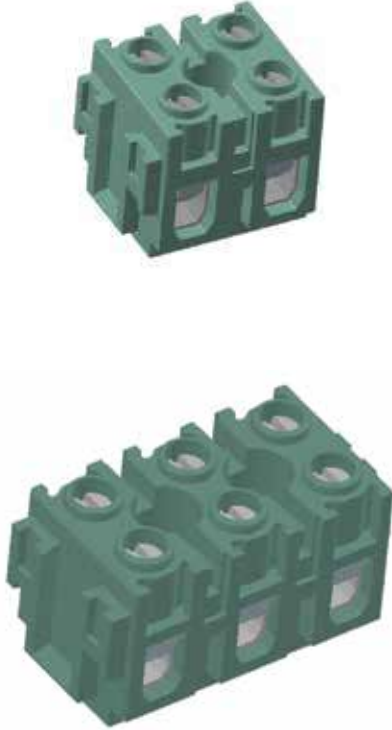

KOD	CİNSİ	AKIM	GERİLİM	AD. / ʘ	K. AD.
● ONKA - 5100	No 1 (2,5 - 4 mm ²)	32 A	400 V	2,17	250
● ONKA - 5101	No 2 (4 - 6 mm ²)	41 A	400 V	2,82	144
● ONKA - 5102	No 3 (6 - 10 mm ²)	57 A	400 V	4,08	75
● ONKA - 5103	No 1-3'lü (2,5 - 4 mm ²)	32 A	400 V	3,00	200
● ONKA - 5163	No 1 (2,5 - 4 mm ²)	32 A	400 V	2,17	250
● ONKA - 5183	No 2 (4 - 6 mm ²)	41 A	400 V	2,82	144
● ONKA - 5193	No 3 (6 - 10 mm ²)	57 A	400 V	4,08	75
● ONKA - 5173	No 1-3'lü (2,5 - 4 mm ²)	32 A	400 V	3,00	200
● ONKA - 5164	No 1 (2,5 - 4 mm ²)	32 A	400 V	2,17	250
● ONKA - 5184	No 2 (4 - 6 mm ²)	41 A	400 V	2,82	144
● ONKA - 5194	No 3 (6 - 10 mm ²)	57 A	400 V	4,08	75
● ONKA - 5174	No 1-3'lü (2,5 - 4 mm ²)	32 A	400 V	3,00	200
● ONKA - 5161	No 1 (2,5 - 4 mm ²)	32 A	400 V	2,17	250
● ONKA - 5181	No 2 (4 - 6 mm ²)	41 A	400 V	2,82	144
● ONKA - 5191	No 3 (6 - 10 mm ²)	57 A	400 V	4,08	75
● ONKA - 5171	No 1-3'lü (2,5 - 4 mm ²)	32 A	400 V	3,00	200
● ONKA - 5162	No 1 (2,5 - 4 mm ²)	32 A	400 V	2,17	250
● ONKA - 5182	No 2 (4 - 6 mm ²)	41 A	400 V	2,82	144
● ONKA - 5192	No 3 (6 - 10 mm ²)	57 A	400 V	4,08	75
● ONKA - 5172	No 1-3'lü (2,5 - 4 mm ²)	32 A	400 V	3,00	200

Renkler



KOD	CİNSİ	AKIM	GERİLİM	AD. / ʘ	K. AD.
ONKA - 5130	Mini klemens (Aspiratör) 2.5 - 4 mm ²	32 A	400 V	1,26	250



STEATİT KLEMENSLERİN ÜSTÜNLÜKLERİ

Steatit; elektroteknikte yalıtkan parçaların üretiminde kullanılan, klasik elektroporselene nazaran çok daha yüksek elektriksel ve mekaniksel dayanıma sahip bir malzeme olarak tanımlanabilir.

Elektrik enerjisi tüketiminin içerisinde bulunduğumuz yüzyılda hızla artış göstermesi, üretim, iletim ve kullanım safhalarında seramik izolasyon malzemelerine olan talebi de hızla arttırmıştır. Hidroelektrik, termik, nükleer enerji v.b. gibi santrallerin dağıtım ve iletim ünitelerinde yüksek güçleri taşıyabilecek seramik izolatörlerin yanında, yüksek izolasyon sağlayabilen seramik aksam ve parçaların özelliklerinin iyileştirilmesi ihtiyacı ön plana çıkmıştır.

Elektroporselenin bu noktadan itibaren ihtiyaçlara cevap veremediği görülmüş ve 1930 'lardan itibaren elektrik izolatörlerinde porselen yerine steatit kullanımı yaygınlaşmaya başlamıştır.



STEATİT KLEMENSİN PORSELEN KLEMENSE GÖRE ÜSTÜNLÜKLERİ

- Steatit; elektroporselene göre ;
- Daha yüksek mekaniksel dayanıma,
- Daha yüksek boyutsal kararlılık,
- Daha yüksek sıcaklık dayanımına (1000 °C ve üzeri),
- Daha yüksek asit dayanımına,
- Daha uzun kullanım ömrüne,
- Daha yalıtkan bir yüzeye sahip ve yüzeysel elektrik kaçağı sıfır olan, çok üstün bir malzemedir.

ONKA Steatit klemensleri kontak malzemesi özel alaşımli çeliktir ve ısıl çalışma sıcaklığı 1100 °C'ye ulaşmaktadır. Bu da ONKA steatit klemensin çalışma sıcaklığını otomatik olarak 1000 °C'nin üzerine taşımaktadır. (Piyasadaki elektroporselen klemenslerin kontakları 350 °C'ye kadar ısıya dayanıklı olduğundan daha yüksek ısı dayanımı gerekli yerlerde kullanımı sakıncalıdır.)

KOD	EBAT	Pole	A (mm)	B (mm)	C (mm)	D Ø (mm)	M Ø (mm)	AD. / ʘ	K. AD.
ONKA-5081	No. 0/2	2	22	16,5	18,5	4	4,3	3,94	150
ONKA-5082	No. 1/2	2	22,5	17	19	5	4,3	4,39	150
ONKA-5083	No. 1/3	3	36	17	19	5	4,3	5,85	100
ONKA-5084	No. 2/2	2	27	18,5	22	6	4,3	5,20	100
ONKA-5085	No. 2/3	3	40	18,5	22	6	4,3	7,11	50
ONKA-5086	No. 3/2	2	34	24,5	30	7	5,2	9,39	50
ONKA-5087	No. 3/3	3	51,5	25	30	7	5,2	13,47	35
ONKA-5088	No. 0/1	1	11	16,5	18,5	4	-	3,38	400
ONKA-5089	No. 1/1	1	11,5	17	19	5	-	3,26	350
ONKA-5090	No. 2/1	1	12	18,8	22	6	-	3,75	200
ONKA-5091	No. 3/1	1	17	25	30,3	7	-	6,29	100
ONKA-5093	No. 4/3	3	65,6	30	30	11	5,2	23,55	20
ONKA-5094	No. 5/3	3	65,6	30	30	11	5,2	23,55	20
ONKA-5095	No. 5/2	2	42	30	30	11	5,2	18,18	20

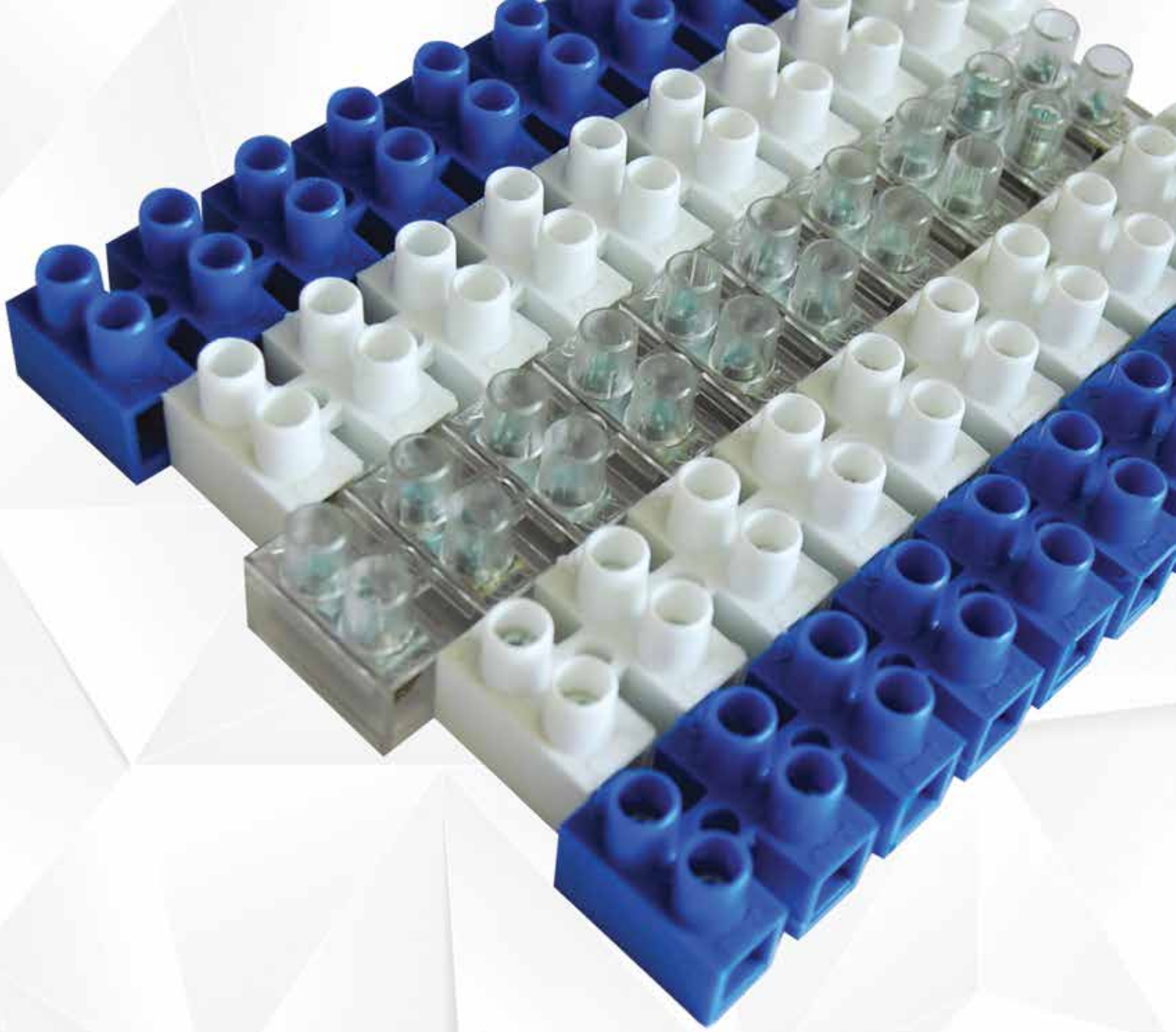

SIRA KLEMENSLER

Ürünlerin kontak yapısı, özel alaşımlı Ck 45 malzemeden yüksek teknoloji insan odaklı üretim hatalarından etkilenmeyen otomasyon sistemleri ile üretilmektedir. Atmosferik ortamlardan arındırılmış özel dizayn kapalı fırınlarda 36.6 HRC kadar sertleştirilmesi sayesinde ürünün defalarca iletken bağlanıp sökülmesinden kaynaklı deformasyonlara karşı yüksek derecede dayanıklılık sağlanmıştır.

V2 Seri ürünlerde gövde yapısı 140 °C derece ısıya dayanıma sahip olan Polyamid 6 malzemeden üretilmektedir. Polyamid 6 hammadde; kopma, eğilme, darbe, aşınma mukavemeti sağlar ve çekme, basma elastikiyeti yüksektir.

Tüm bu termik ve mekanik üstünlükler ile Polyamid 6 dış ortam koşullarına karşı da max. dayanıklı bir ürün elde etmemizi sağlar.

TS EN 60335-1 Standartlarına uygun V0 yanmazlık seviyesinde, 200 °C dayanımlı ürün serimiz; Elektrikli ev aletleri ve endüstriyel uygulamalar için özel olarak tasarlanmış yüksek ısıya dayanıklı cam elyaf katkılı PA6 gövde yapısıyla tam güvenlik sağlar. Farklı kesit - renk - vida - kovan - pin sayılarıyla proje ve ihtiyaçlarınıza özel olarak da üretilmektedir.

Kontakt yapısına uygun sertlik değeri ile üretilen çelik vida ile kullanım koşullarında deforme olmayan bir dayanıklılık kombinasyonu oluşturulmuştur.

ONKA Elektrik, ISO 9001-2015 kalite yönetim sistemi ile yaptığı üretimlerle, kalitesini uluslararası sertifikalar ile tescillemiştir.



PLASTİK SIRA KLEMENSLER, VİDA BLOKAJLI - (MAVİ)



KOD	CİNSİ	GERİLİM	AKIM	AD. / ʘ	K. AD.
ONKA - 5000	No. 0 0.75 - 1.5 mm ² 'lik 12 Sıra	400	17.5	7,11	100
ONKA - 5001	No. 1 2.5 - 4 mm ² 'lik 12 Sıra	400	32	6,85	50
ONKA - 5002	No. 2 4 - 6 mm ² 'lik 12 Sıra	400	41	8,87	50
ONKA - 5003	No. 3 6 - 10 mm ² 'lik 10 Sıra	400	57	10,67	50
ONKA - 5004	No. 4 10 - 16 mm ² 'lik 6 Sıra	500	76	10,18	50
ONKA - 5005	No. 5 16 - 25 mm ² 'lik 6 Sıra	500	101	15,08	50

ISIYA DAYANIKLI PLASTİK, VİDA BLOKAJLI - (BEYAZ - KIRMIZI) 140 °C V2, TSE, OSK



KOD	CİNSİ	GERİLİM	AKIM	AD. / ʘ	K. AD.
ONKA - 5010	No. 0 0.75 - 1.5 mm ² 'lik 12 Sıra	400	17.5	7,47	100
ONKA - 5011	No. 1 2.5 - 4 mm ² 'lik 12 Sıra	400	32	7,25	50
ONKA - 5012	No. 2 4 - 6 mm ² 'lik 12 Sıra	400	41	9,80	50
ONKA - 5013	No. 3 6 - 10 mm ² 'lik 10 Sıra	400	57	12,02	50
ONKA - 5014	No. 4 10 - 16 mm ² 'lik 6 Sıra	500	76	11,64	50
ONKA - 5015	No. 5 16 - 25 mm ² 'lik 6 Sıra	500	101	16,97	50
ONKA - 5016	No. 3 3'lü 6 - 10 mm ² 'lik 3 Sıra 3 Sıra	400	57	4,38	250

ISIYA DAYANIKLI PLASTİK, VİDA BLOKAJLI - (ŞEFFAF - POLİKARBON)



KOD	CİNSİ	GERİLİM	AKIM	AD. / ʘ	K. AD.
ONKA - 5020	No. 0 0.75 - 1.5 mm ² 'lik 12 Sıra	400	17.5	7,65	100
ONKA - 5021	No. 1 2.5 - 4 mm ² 'lik 12 Sıra	400	32	7,64	50
ONKA - 5022	No. 2 4 - 6 mm ² 'lik 12 Sıra	400	41	10,43	50
ONKA - 5023	No. 3 6 - 10 mm ² 'lik 10 Sıra	400	57	12,56	50
ONKA - 5024	No. 4 10 - 16 mm ² 'lik 6 Sıra	500	76	11,83	50
ONKA - 5025	No. 5 16 - 25 mm ² 'lik 6 Sıra	500	101	17,14	50
ONKA - 5026	No. 3 3'lü 6 - 10 mm ² 'lik 3 Sıra	400	57	4,43	250

PANO İÇİ CAM ELYAF TAKVİYELİ, VİDA BLOKAJLI - (200° PA6-V0)



KOD	CİNSİ	GERİLİM	AKIM	AD. / ʘ	K. AD.
ONKA - 5029	No. 0 0.75 - 1.5 mm ² 'lik 12 Sıra	400	17.5	8,52	100
ONKA - 5030	No. 1 2.5 - 4 mm ² 'lik 12 Sıra	400	32	8,76	50
ONKA - 5031	No. 2 4 - 6 mm ² 'lik 12 Sıra	400	41	11,94	50
ONKA - 5032	No. 3 6 - 10 mm ² 'lik 10 Sıra	400	57	15,09	50
ONKA - 5033	No. 4 10 - 16 mm ² 'lik 6 Sıra	500	76	14,65	50
ONKA - 5034	No. 5 16 - 25 mm ² 'lik 6 Sıra	500	101	20,73	50
ONKA - 5035	No. 3 3'lü 6 - 10 mm ² 'lik 3 Sıra	400	57	5,29	250

PALETLİ ISIYA DAYANIKLI, VİDA BLOKAJLI - (BEYAZ - KIRMIZI) 140 °C V2



KOD	CİNSİ	GERİLİM	AKIM	AD. / ʘ	K. AD.
ONKA - 5040	No. 1 2.5 - 4 mm ² 'lik 12 Sıra	400	32	9,01	50
ONKA - 5041	No. 2 4 - 6 mm ² 'lik 12 Sıra	400	41	11,73	50
ONKA - 5042	No. 3 6 - 10 mm ² 'lik 10 Sıra	400	57	14,14	50
ONKA - 5043	No. 3 3'lü 6 - 10 mm ² 'lik 3 Sıra	400	57	5,54	250

PALETLİ ISIYA DAYANIKLI, VİDA BLOKAJLI - (ŞEFFAF - POLİKARBON)



KOD	CİNSİ	GERİLİM	AKIM	AD. / ʘ	K. AD.
ONKA - 5050	No. 1 2.5 - 4 mm ² 'lik 12 Sıra	400	32	9,39	50
ONKA - 5051	No. 2 4 - 6 mm ² 'lik 12 Sıra	400	41	12,37	50
ONKA - 5052	No. 3 6 - 10 mm ² 'lik 10 Sıra	400	57	14,66	50
ONKA - 5053	No. 3 3'lü 6 - 10 mm ² 'lik 3 Sıra	400	57	5,51	250

PALETLİ CAM ELYAF TAKVİYELİ, VİDA BLOKAJLI - (200 °C - PA6-V0)



KOD	CİNSİ	GERİLİM	AKIM	AD. / ʘ	K. AD.
ONKA - 5056	No. 1 2.5 - 4 mm ² 'lik 12 Sıra	400	32	10,38	50
ONKA - 5057	No. 2 4 - 6 mm ² 'lik 12 Sıra	400	41	14,14	50
ONKA - 5058	No. 3 6 - 10 mm ² 'lik 10 Sıra	400	57	17,19	50
ONKA - 5059	No. 3 3'lü 6 - 10 mm ² 'lik 3 Sıra	400	57	6,37	250

KLEMENS TAPASI VE PLASTİK VİDA



KOD	CİNSİ	AD. / ʘ	K./AD.
ONKA-5071	Klemens Tapası (12'li)	0,20	100

KAPAKLI TERMİNAL KLEMENSLER 25 A

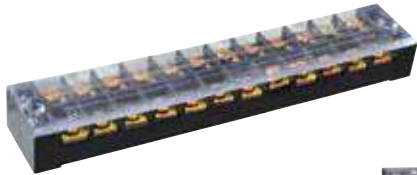

KOD	CİNSİ	AD. / ʘ	K. AD.
ONKA - 5145	25 A 600V Terminal-3	9,65	50
ONKA - 5146	25 A 600V Terminal-4	13,40	50
ONKA - 5147	25 A 600V Terminal-6	19,50	50
ONKA - 5148	25 A 600V Terminal-12	38,15	25



2'Lİ MODÜLER SİSTEM SOKET KLEMENSLER (MS 58 PİRİNÇ İLETKEN - 24 A)



KOD	CİNSİ	AD. / ʘ	K. AD.
ONKA - 5068	NO. 1 - 2'li Soket Klemensi + Modüler Sistem (2,5 - 4mm ²)	6,74	180
5068/BEYAZ	5451/KIRMIZI	5453/SARI	5042/SİYAH

3'LÜ SOKET KLEMENS (MS 58 PİRİNÇ İLETKEN - 24 A)



KOD	CİNSİ	AD. / ʘ	K. AD.
ONKA - 5065 BEYAZ	NO. 1 3'lü Soket Klemensi (2,5 - 4mm ²)	11,04	100
ONKA - 5411 SİYAH			
ONKA - 5066 BEYAZ	Soket Klemensi Kapağı (Takım)	3,80	45
ONKA - 5421 SİYAH			
ONKA - 5067 BEYAZ	NO. 1 3'lü (2,5 - 4mm ²) Soket Klemensi + Kapak Takımı	16,80	45
ONKA - 5431 SİYAH			

3'LÜ SOKET KLEMENS T BAĞLANTI APARATI (MS 58 PİRİNÇ İLETKEN - 24 A)



KOD	CİNSİ	AD. / ʘ	K. AD.
ONKA - 5074 Beyaz	2.5 - 4 mm ² T Bağlantı Aparatı	8,57	60
ONKA - 5075 Siyah			

6'Lİ SOKET KLEMENS BAĞLANTI APARATI (MS 58 PİRİNÇ İLETKEN - 24 A)



KOD	CİNSİ	AD. / ʘ	K. AD.
ONKA - 5064 Beyaz	No:1, 2.5 - 4 mm ² 6'lı soket kapak takım	29,33	16
ONKA - 5063 Siyah			16

12'Lİ SOKET KLEMENS (MS 58 PİRİNÇ İLETKEN - 24 A)



KOD	CİNSİ	AD. / ʘ	K. AD.
ONKA - 5060 BEYAZ	No. 1-12 2.5 - 4 mm ² lik (Erkek Dişi Geçmeli Kilitli) (İstenilen Modül sayısında kesim yapılır.)	33,96	30
5060/BEYAZ	5401/GRİ	5402/KIRMIZI	5403/MAVİ
		54046/YEŞİL	5405/SİYAH

turuncularını siyah yap

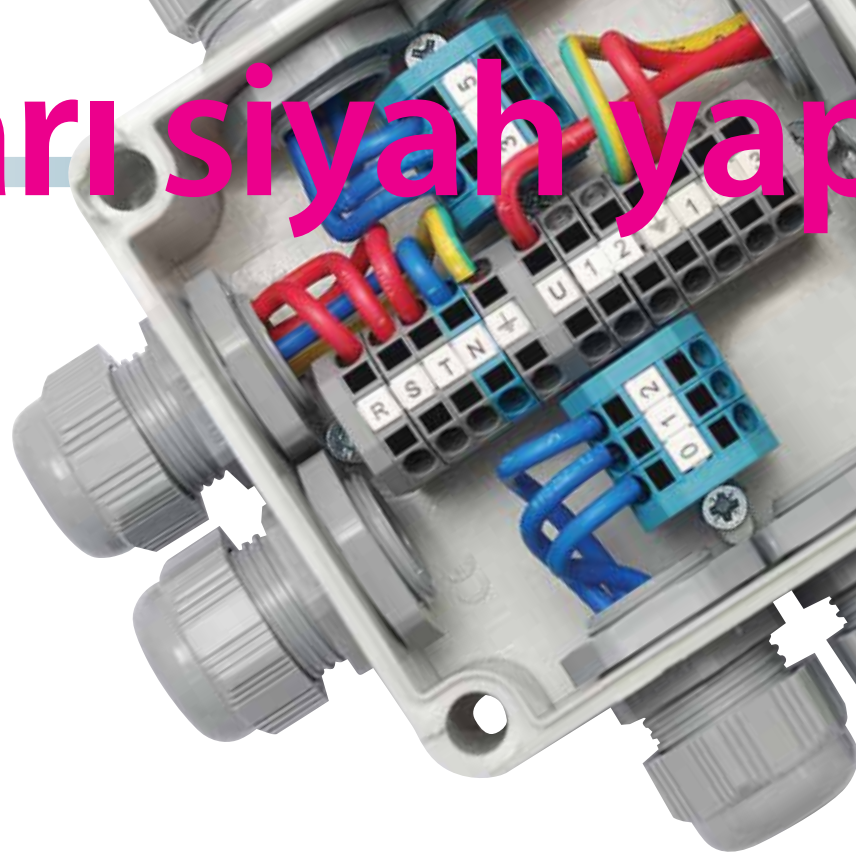

BUAT İÇİ YAY BASKILI PUSH-IN SİSTEM MİNİ KLEMENSLER

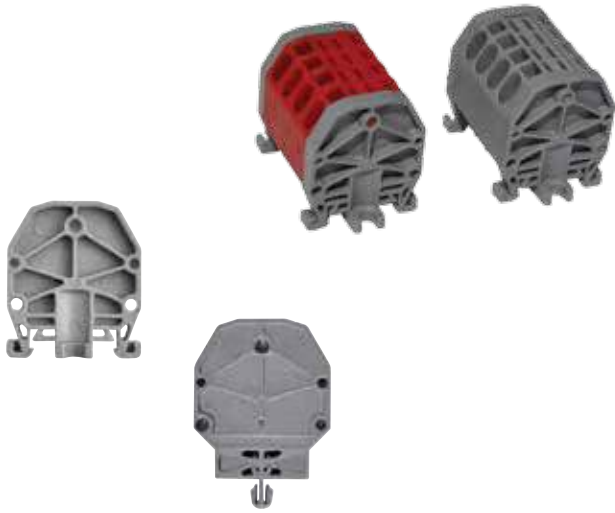

KOD	CİNSİ	AD. / ʘ	K. / AD.
ONKA - 5641	1 x 2.5 mm ² 1 Giriş, 1 Çıkış		50
ONKA - 5651	2 x 2.5 mm ² 1 Giriş, 3 Çıkış		50
ONKA - 5661	3 x 2.5 mm ² 1 Giriş, 5 Çıkış	ʘ	50
ONKA - 5671	4 x 2.5 mm ² 1 Giriş, 7 Çıkış		50
ONKA - 5681	5 x 2.5 mm ² 1 Giriş, 9 Çıkış		50
ONKA - 1442	15 x 5 raya ve zemine sabitleme aparatı	0,68	50
ONKA - 1452	Delikli zemine sabitleme aparatı	0,68	50

BUAT İÇİ YAY BASKILI KONNEKTÖRLERİN RENK KODLARI



VİDALI ŞEFFAF (RENKLİ) BUAT İÇİ KLEMENS

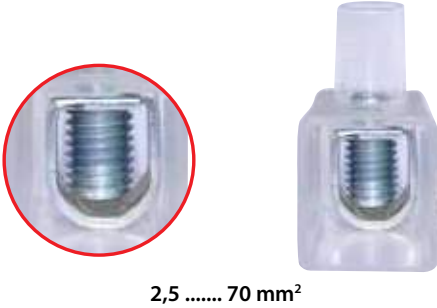

2,5 70 mm²

KOD	CİNSİ	AKIM	GERİLİM	AD. / ʘ	K. AD.
ONKA - 5504	No 1 2,5-4 mm ²	32 A	400 V	0,59	600
ONKA - 5514	No 2 4-6 mm ²	41 A	400 V	0,60	600
ONKA - 5524	No 3 6-10 mm ²	57 A	400 V	0,78	600
ONKA - 5534	No 4 10-16 mm ²	76 A	500 V	1,08	500
ONKA - 5544	No 5 16-25 mm ²	101 A	500 V	1,81	500
ONKA - 5554	No 6 25-35 mm ²	125 A	500 V	3,29	200
ONKA - 5564	No 7 35-50 mm ²	?? A	500 V	ʘ	ʘ
ONKA - 5574	No 8 50-70 mm ²	?? A	500 V	ʘ	ʘ

VİDALI YİVLİ BUAT KLEMENSLERİ

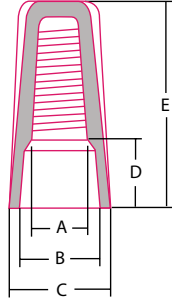

KOD	RENK	A	B	C	D	E	AD. / ʘ	K. / AD.
ONKA - 8340 / P-1	Gri	3.80	6.70	8.60	5.80	15.20	0,234	1000
ONKA - 8341 / P-2	Mavi	4.10	7.00	9.80	5.90	17.60	0,273	1000
ONKA - 8342 / P-3	Oranj	5.00	9.90	12.20	7.80	22.00	0,390	500
ONKA - 8343 / P-4	Sarı	6.00	11.20	14.00	7.90	24.00	0,507	500
ONKA - 8344 / P-6	Kırmızı	7.50	13.00	16.40	9.15	26.50	0,780	500

Dayanıklı Termoplastik hammaddeden imal edilmiş olup, UL 94 / V2 normunda 105 °C çalışma sıcaklığında, bina elektrik tesisatları için 600 V, aydınlatma ve sinyalizasyon için 1000 V'a dayanabilme özelliğine sahiptir.

VİDALI YİVLİ BUAT KLEMENSLERİ (KULAKLI TİP)

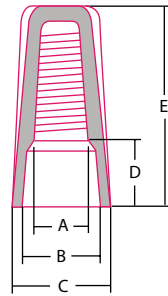

KOD	RENK	A	B	C	D	E	AD. / ʘ	K. / AD.
ONKA - 8345 P-11	Sarı	6.40	9.80	18.20	9.00	25.80	0,555	500
ONKA - 8346 P-12	Bej	7.20	11.60	18.30	9.20	29.00	0,585	500
ONKA - 8347 P-13	Kırmızı	9.00	13.50	23.00	9.60	31.80	0,663	500
ONKA - 8348 P-15	Gri	10.00	14.90	25.50	10.00	33.30	1,053	250
ONKA - 8349 P-17	Mavi	12.00	18.80	32.00	13.00	40.0	1,170	100

Dayanıklı Termoplastik hammaddeden imal edilmiş olup, UL 94 / V2 normunda 105 °C çalışma sıcaklığında, bina elektrik tesisatları için 600 V, aydınlatma ve sinyalizasyon için 1000 V'a dayanabilme özelliğine sahiptir.

YÜKSÜKLÜ BUAT KLEMENSİ (ŞEFFAF)

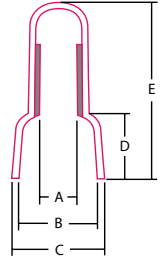

KOD	A	B	C	D	E	AD. / ʘ	K. / AD.
ONKA - 8330 CE-1	2.6	6.2	7.8	6.2	18.0	0,144	1000
ONKA - 8331 CE-2	3.1	7.9	9.5	7.2	19.7	0,168	1000
ONKA - 8332 CE-5	4.1	10.5	12.5	9.6	25.5	0,293	1000
ONKA - 8333 CE-8	5.3	12.4	14.6	12.0	27.7	0,878	500

Naylon 66 hammaddeden imal edilmiş olup, UL 94 / V2 normunda, 105 °C çalışma sıcaklığında 300 Volt Enerjiye Dayanabilme özelliğine sahiptir. (CE - 8) Modeli 600 Volt Enerjiye Dayanabilme.

AÇ KAPA BUAT KLEMENSİ (TÜM KABLO ÇEŞİTLERİ İÇİN)

PUSH IN

- Nominal akım: 32 A
- Nominal gerilim: 450 V
- 0.14-4 mm² (24-12 AWG)
- 0.2-4 mm² (24-12 AWG)

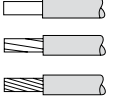

KOD	AÇIKLAMA	AD. / \$	K. / AD.
ONKA-8840	2 İletken Bağlantılı	0,25 \$	100
ONKA-8842	3 İletken Bağlantılı	0,35 \$	100
ONKA-8844	5 İletken Bağlantılı	0,45 \$	100

GEÇMELİ BUAT KLEMENSLER (RENKLİ VE ŞEFFAF)

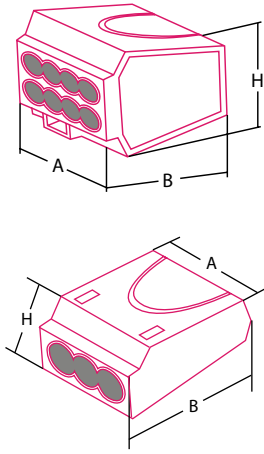

ŞEFFAF KOD	RENKLİ KOD	RENK	KABLO KESİTİ	A	B	H	AD. / \$	K. AD.
ONKA - 8320	ONKA - 8339	2 Kutup Kırmızı	2.5 mm ²	10.5	19.5	9.5	0,13 \$	100
ONKA - 8321	ONKA - 8350	3 Kutup Turuncu	2.5 mm ²	13.5	19.7	9.5	0,16 \$	100
ONKA - 8322	ONKA - 8351	4 Kutup Sarı	2.5 mm ²	17.2	19.7	9.5	0,19 \$	100
ONKA - 8323	ONKA - 8352	5 Kutup Gri	2.5 mm ²	21.1	19.7	9.5	0,23 \$	100
ONKA - 8463	ONKA - 8464	6 Kutup Beyaz	2.5 mm ²	22.0	19.7	9.5	0,29 \$	100
ONKA - 8324	ONKA - 8353	8 Kutup Beyaz	2.5 mm ²	17.5	19.0	16.8	0,34 \$	100

Termoplastik hammaddeden imal edilmiş olup, UL 94 / V2 normunda, 105 °C çalışma sıcaklığında 600 volt elektrik iletkenliğine sahip 24 A akım geçirgenliğine sahiptir.

UYGULAMA ŞEKLİ

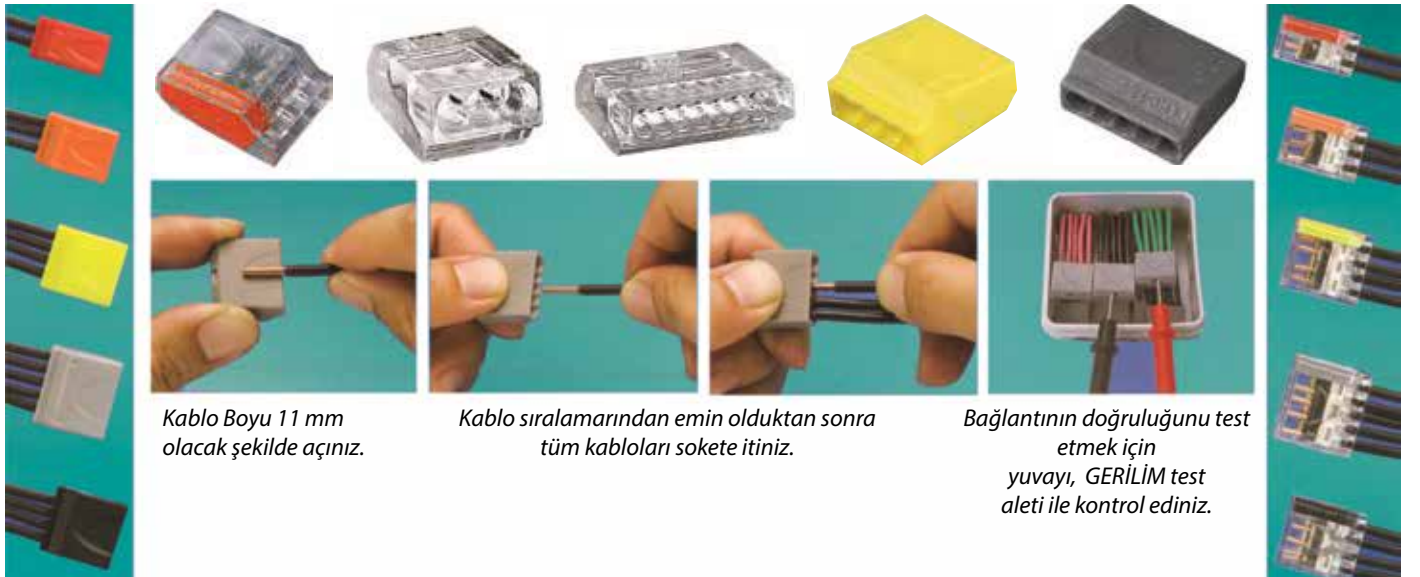

Kablo Boyu 11 mm olacak şekilde açınız.

Kablo sıralamalarından emin olduktan sonra tüm kabloları sokete itiniz.

Bağlantının doğruluğunu test etmek için yuvayı, GERİLİM test aleti ile kontrol ediniz.

PRATİK BAĞLANTI KLEMENSLERİ

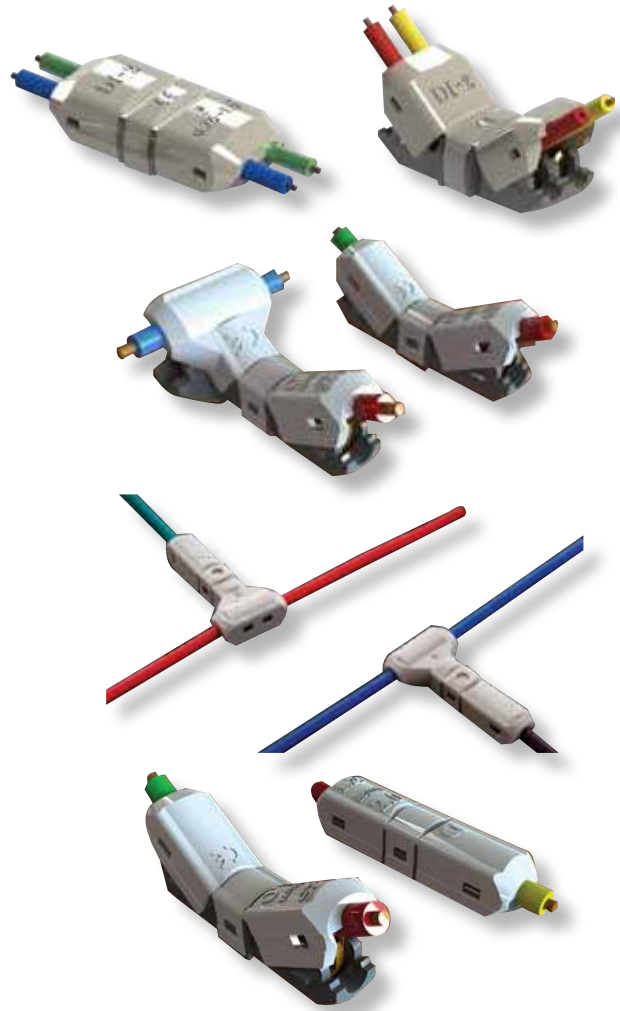

WATERPROOF

HT Tip	HDI Tip	HI Tip

I TİPİ PRATİK BAĞLANTI KLEMENSLERİ



KOD	AÇIKLAMA	AD. / \$	K. / AD.
ONKA - I1	3A Beyaz 0,3 ~ 0,5 mm ²	0,40 \$	100



KOD	AÇIKLAMA	AD. / \$	K. / AD.
ONKA - I2	10A Gri 0,6 ~ 1,0 mm ²	0,48 \$	100



KOD	AÇIKLAMA	AD. / \$	K. / AD.
ONKA - I3	15A Sarı 1,5 mm ²	0,72 \$	100



KOD	AÇIKLAMA	AD. / \$	K. / AD.
ONKA - I4	20A Yeşil 2,5 mm ²	1,00 \$	100



KOD	AÇIKLAMA	AD. / \$	K. / AD.
ONKA - I5	25A Turuncu 4,0 mm ²	1,32 \$	100



KOD	AÇIKLAMA	AD. / \$	K. / AD.
ONKA - DI-1	3A Beyaz 0,3 ~ 0,5 mm ²	0,68 \$	100



KOD	AÇIKLAMA	AD. / \$	K. / AD.
ONKA - DI-2	10A Gri 0,6 ~ 1,0 mm ²	0,80 \$	100



KOD	AÇIKLAMA	AD. / \$	K. / AD.
ONKA - S44	20A 2,5 mm ²	0,36 \$	100



KOD	AÇIKLAMA	AD. / \$	K. / AD.
ONKA - R44	20A 2,5 mm ²	0,36 \$	100

T TİPİ PRATİK BAĞLANTI KLEMENSLERİ



KOD	AÇIKLAMA	AD. / \$	K. / AD.
ONKA - T1	3A Beyaz 0,3 ~ 0,5 mm ²	0,48 \$	100



KOD	AÇIKLAMA	AD. / \$	K. / AD.
ONKA - T2	10A Gri 0,6 ~ 1,0 mm ²	0,60 \$	100



KOD	AÇIKLAMA	AD. / \$	K. / AD.
ONKA - T3	15A Sarı 1,5 mm ²	0,88 \$	100



KOD	AÇIKLAMA	AD. / \$	K. / AD.
ONKA - T4	20A Yeşil 2,5 mm ²	1,12 \$	100



KOD	AÇIKLAMA	AD. / \$	K. / AD.
ONKA - T5	25A Turuncu 4,0 mm ²	1,52 \$	100



KOD	AÇIKLAMA	AD. / \$	K. / AD.
ONKA - T-21	3A Gri (T)Giriş: 0,6 ~ 1,0 mm ² (I)Çıkış: 0,1 ~ 0,5 mm ²	0,48 \$	100



KOD	AÇIKLAMA	AD. / \$	K. / AD.
ONKA - D-21	3A Beyaz (T)Giriş: 0,75 ~ 1,0 mm ² (I)Çıkış: 0,2 ~ 0,5 mm ²	0,88 \$	100



KOD	AÇIKLAMA	AD. / \$	K. / AD.
ONKA - 4C-4	20A 2,5 mm ²	1,28 \$	100



KOD	AÇIKLAMA	AD. / \$	K. / AD.
ONKA - 6C-4	20A 2,5 mm ²	1,60 \$	100

KCG TİPİ KABLO ETİKETLERİ (KABLOYA ÜSTTEN GEÇMELİ, MONTAJDAN ÖNCE ve SONRA TAKILABİLEN)

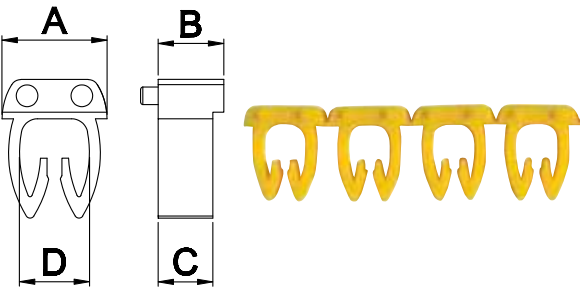
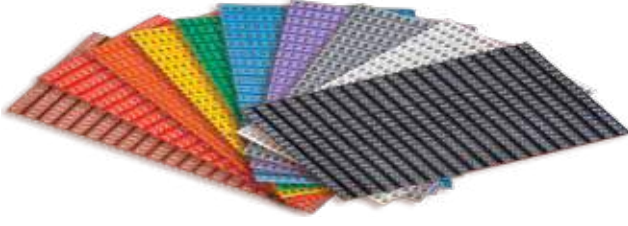

ÖLÇÜ (mm)	NO	A	B	C	D
	1	4,4	3	2,5	2,7
2	5	3	2,5	3,2	
3	7,4	3	2,5	4,9	

TEKNİK DETAY

HAMMADDE	PA6.6
ÇALIŞMA SICAKLIĞI	-40 °C, +140 °C
YAZI RENGİ	Siyah & Beyaz
UYGUN KABLO KESİTLERİ	No1 : 0,75 - 1,50 mm ² No2 : 1,50 - 2,50 mm ² No3 : 4,00 - 6,00 mm ²

KOD	ÖLÇÜ	KUTU t	KUTU / KOLİ AD.
ONKA-9848	NO:1 0,75 - 1,50 mm ² CABLE MARKER O PRINTED	18,00	400/20.000
ONKA-9849	NO:1 0,75 - 1,50 mm ² CABLE MARKER 1 PRINTED	18,00	400/20.000
ONKA-9852	NO:1 0,75 - 1,50 mm ² CABLE MARKER 2 PRINTED	18,00	400/20.000
ONKA-9853	NO:1 0,75 - 1,50 mm ² CABLE MARKER 3 PRINTED	18,00	400/20.000
ONKA-9854	NO:1 0,75 - 1,50 mm ² CABLE MARKER 4 PRINTED	18,00	400/20.000
ONKA-9855	NO:1 0,75 - 1,50 mm ² CABLE MARKER 5 PRINTED	18,00	400/20.000
ONKA-9856	NO:1 0,75 - 1,50 mm ² CABLE MARKER 6 PRINTED	18,00	400/20.000
ONKA-9857	NO:1 0,75 - 1,50 mm ² CABLE MARKER 7 PRINTED	18,00	400/20.000
ONKA-9858	NO:1 0,75 - 1,50 mm ² CABLE MARKER 8 PRINTED	18,00	400/20.000
ONKA-9859	NO:1 0,75 - 1,50 mm ² CABLE MARKER 9 PRINTED	18,00	400/20.000
ONKA-9866	NO:1 0,75 - 1,50 mm ² CABLE MARKER A PRINTED	18,00	400/20.000
ONKA-9867	NO:1 0,75 - 1,50 mm ² CABLE MARKER B PRINTED	18,00	400/20.000
ONKA-9868	NO:1 0,75 - 1,50 mm ² CABLE MARKER C PRINTED	18,00	400/20.000
ONKA-9869	NO:1 0,75 - 1,50 mm ² CABLE MARKER D PRINTED	18,00	400/20.000
ONKA-9870	NO:1 0,75 - 1,50 mm ² CABLE MARKER E PRINTED	18,00	400/20.000
ONKA-9871	NO:1 0,75 - 1,50 mm ² CABLE MARKER F PRINTED	18,00	400/20.000
ONKA-9872	NO:1 0,75 - 1,50 mm ² CABLE MARKER G PRINTED	18,00	400/20.000
ONKA-9873	NO:1 0,75 - 1,50 mm ² CABLE MARKER H PRINTED	18,00	400/20.000
ONKA-9874	NO:1 0,75 - 1,50 mm ² CABLE MARKER I PRINTED	18,00	400/20.000
ONKA-9875	NO:1 0,75 - 1,50 mm ² CABLE MARKER J PRINTED	18,00	400/20.000
ONKA-9876	NO:1 0,75 - 1,50 mm ² CABLE MARKER K PRINTED	18,00	400/20.000
ONKA-9877	NO:1 0,75 - 1,50 mm ² CABLE MARKER L PRINTED	18,00	400/20.000
ONKA-9879	NO:1 0,75 - 1,50 mm ² CABLE MARKER M PRINTED	18,00	400/20.000
ONKA-9880	NO:1 0,75 - 1,50 mm ² CABLE MARKER N PRINTED	18,00	400/20.000
ONKA-9881	NO:1 0,75 - 1,50 mm ² CABLE MARKER O PRINTED	18,00	400/20.000
ONKA-9882	NO:1 0,75 - 1,50 mm ² CABLE MARKER P PRINTED	18,00	400/20.000
ONKA-9884	NO:1 0,75 - 1,50 mm ² CABLE MARKER R PRINTED	18,00	400/20.000
ONKA-9885	NO:1 0,75 - 1,50 mm ² CABLE MARKER S PRINTED	18,00	400/20.000
ONKA-9887	NO:1 0,75 - 1,50 mm ² CABLE MARKER T PRINTED	18,00	400/20.000
ONKA-9888	NO:1 0,75 - 1,50 mm ² CABLE MARKER U PRINTED	18,00	400/20.000
ONKA-9889	NO:1 0,75 - 1,50 mm ² CABLE MARKER V PRINTED	18,00	400/20.000
ONKA-9890	NO:1 0,75 - 1,50 mm ² CABLE MARKER W PRINTED	18,00	400/20.000
ONKA-9891	NO:1 0,75 - 1,50 mm ² CABLE MARKER X PRINTED	18,00	400/20.000
ONKA-9892	NO:1 0,75 - 1,50 mm ² CABLE MARKER Y PRINTED	18,00	400/20.000
ONKA-9893	NO:1 0,75 - 1,50 mm ² CABLE MARKER Z PRINTED	18,00	400/20.000
ONKA-9878	NO:1 0,75 - 1,50 mm ² CABLE MARKER Mp PRINTED	18,00	400/20.000
ONKA-9863	NO:1 0,75 - 1,50 mm ² CABLE MARKER + PRINTED	18,00	400/20.000
ONKA-9860	NO:1 0,75 - 1,50 mm ² CABLE MARKER - PRINTED	18,00	400/20.000
ONKA-9886	NO:1 0,75 - 1,50 mm ² CABLE MARKER ÷ PRINTED	18,00	400/20.000
ONKA-9862	NO:1 0,75 - 1,50 mm ² CABLE MARKER ~ PRINTED	18,00	400/20.000
ONKA-9883	NO:1 0,75 - 1,50 mm ² CABLE MARKER Q PRINTED	18,00	400/20.000
ONKA-9865	NO:1 0,75 - 1,50 mm ² CABLE MARKER AC PRINTED	18,00	400/20.000

KABLO BAĞI ETİKET TAŞIYICI

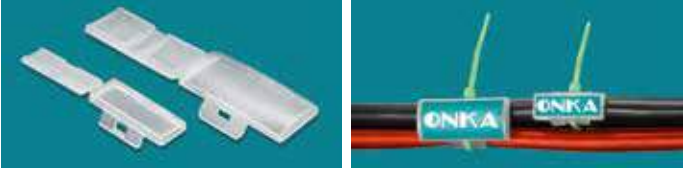

KOD	EN	BOY	AD. / ʘ	K. AD.
ONKA-8560	33	12	0,945	100
ONKA-8561	44	19	1,365	100

KABLOR İÇİN İŞARETLEME ETİKET YATAĞI



KOD	Cinsi	AD. / ʘ	K. AD.
ONKA-7134	2.5 - 3.6 mm Kablo bağları ile bağlanabilir. DB5 mm Klemens etiketleri kullanılabilir. Şeffaf daralan makoronla tam izolasyon yapılabilir.	1,292	100

KABLO BAĞI TUTUCULARI (YAPIŞKANLI ve VİDALI)

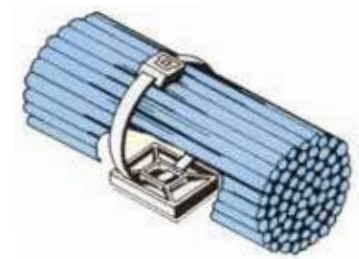
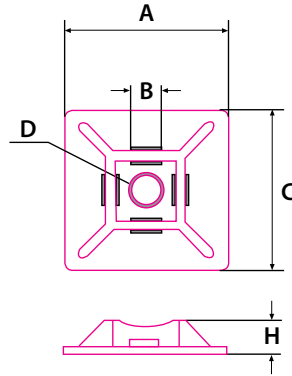

Bant Özelliği 1 mm Kalınlık 120 °C 96 kg/m³ yoğunluk, tam yapışkanlık max. 60 dk



KOD	A	B	C	D	H	AD. / ʘ	K. AD.
ONKA - 8391 / 3A	19	3.6	19	Ø3.2	4.0	0,49	100
ONKA - 8392 / 4A	28	4.8	28	Ø3.2	4.5	0,71	100

PANO ETİKET AYAĞI



UYGULAMA YERİ

KOD	AÇIKLAMA	RENK	KUTU ADEDİ	AD. / ₺
İRPAY-1001	PLASTİK AYAK / PLASTIC LEG	RAL 7035	200	5,32

OTOMAT ALTI ETİKET (YAPIŞKANLI, 2 METRE)



KOD	AÇIKLAMA	1MT./€	KUTU/ MT.
İRPTY-21200	21 x 2000 mm Yapışkanlı Pano Etiketi	1,38 €	200
İRPTY-30200	30 x 2000 mm Yapışkanlı Pano Etiketi	1,54 €	150
İRPTY-40200	40 x 2000 mm Yapışkanlı Pano Etiketi	1,65 €	150

METRELİK PANO ETİKETİ (YAPIŞKANLI)



KOD	CİNSİ	AD. / ₺	K. AD.
ONKA-7126	15 x 1000 mm Yapışkanlı Pano Etiketi	20,41	50

W OTOMAT ÖRTME APARATI (12'Lİ)



KOD	CİNSİ	AD. / ₺	K. AD.
ONKA 7121	W Otomat Örtme Aparatı	3,23	50

W OTOMAT ÖRTME APARATI (2 METRE)

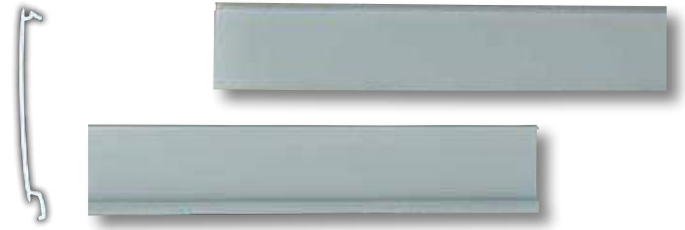

KOD	CİNSİ	1MT./€	MT.
İRWCP7035	2 mt. Örtü Plakası RAL 7035	1,65 €	60
İRWCP7032	2 mt. Örtü Plakası RAL 7032	1,65 €	60
İRWCP9001	2 mt. Örtü Plakası RAL 9001	1,65 €	60

PANO ETİKETLERİ (YAPIŞKANLI ve VİDALANABİLİR)

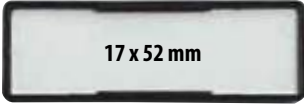
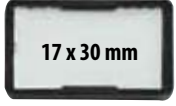

KOD	Cinsi	AD. / ʘ	K. AD.
ONKA-7114	17 x 30 mm	1,09	100
ONKA-7115	17 x 52 mm	1,35	100
ONKA-7116	17 x 70 mm	1,62	50

PANO SİNYAL ve BUTON ETİKETLERİ



İRPSET-3014



İRPSET-3015



İRPSET-3016



İRPSET-3017

KOD	AÇIKLAMA	AD. / ʘ	KOLİ ADEDİ
İRPSET-3014	PANO SİNYAL ETİKETİ 30x14 mm PANEL SIGNAL LABEL 30x14 mm	1,690	100
İRPSET-3015	PANO SİNYAL ETİKETİ 27x12 mm PANEL SIGNAL LABEL 27x12 mm	1,950	100
İRPSET-3016	PANO SİNYAL ETİKETİ 27x18 mm PANEL SIGNAL LABEL 27x18 mm	2,015	100
İRPSET-3017	PANO SİNYAL ETİKETİ 27x12 mm PANEL SIGNAL LABEL 27x12 mm	2,145	100



RAYA MONTAJ (KAPAKLI) PANO PRİZİ (16 A / 250 V)



KOD	AÇIKLAMA	AD. / ʘ	KUTU / KOLİ
ONKA - 7160	Tek Girişli LED'siz Topraklı	38,66	10 / 120
ONKA - 7161	Çift Girişli LED'siz Topraklı	48,05	
ONKA - 7162	Tek Girişli LED'li Topraklı	48,43	
ONKA - 7163	Çift Girişli LED'li Topraklı	57,35	
ONKA - 7164	Tek Girişli LED'siz UPS'li	38,49	
ONKA - 7165	Çift Girişli LED'siz UPS'li	52,88	
ONKA - 7166	Tek Girişli LED'li UPS'li	48,27	
ONKA - 7167	Çift Girişli LED'li UPS'li	61,74	







RAKOR IP68

Sıkmalı Tip
Poliamid Rakorlar



PG POLYAMİD KABLO RAKORU (IP-68)



Renkler   
Ral: 7035 7001 9005

ORİNG



KOD	BOY	MON. ÇAPI	K. AD.	KO. AD.	AD. / ʘ	KOD (ORİNG CONTALI)	AD. / ʘ (ORİNG CONTALI)
ONKA - 9000	PG-7	12.5 mm	450	6750	1,17	ONKA - 9058	1,94
ONKA - 9001	PG-9	15 mm	300	4500	1,47	ONKA - 9059	2,43
ONKA - 9002	PG-11	18.4 mm	200	3000	1,90	ONKA - 9060	2,02
ONKA - 9003	PG-13.5	20 mm	175	2625	2,30	ONKA - 9061	2,40
ONKA - 9004	PG-16	22 mm	125	1875	2,63	ONKA - 9062	3,91
ONKA - 9005	PG-21	28 mm	75	1125	3,88	ONKA - 9063	5,48
ONKA - 9006	PG-29	37 mm	40	600	6,14	ONKA - 9064	7,87
ONKA - 9007	PG-36	47 mm	20	300	12,28	ONKA - 9065	14,01
ONKA - 9008	PG-42	54 mm	15	225	15,10	ONKA - 9066	16,70
ONKA - 9009	PG-48	60 mm	12	180	16,39	ONKA - 9067	17,99

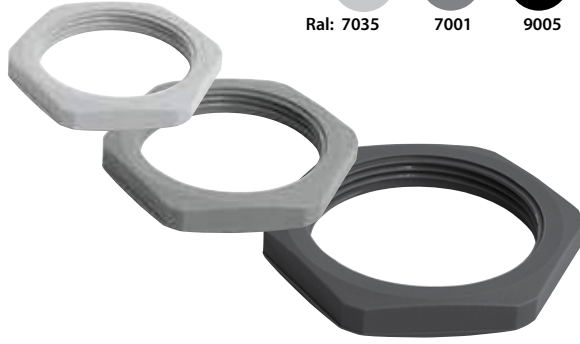

PG POLYAMİD SOMUN

Renkler   
Ral: 7035 7001 9005



KOD	BOY	MONTAJ DELİK	K. / AD.	AD. / ʘ
ONKA - 9070	PG-7	12.5	250	0,27
ONKA - 9071	PG-9	15.5	250	0,33
ONKA - 9072	PG-11	18.5	250	0,41
ONKA - 9073	PG-13.5	20.5	250	0,53
ONKA - 9074	PG-16	22.5	250	0,55
ONKA - 9075	PG-21	28.5	250	0,84
ONKA - 9076	PG-29	37.5	150	1,40
ONKA - 9077	PG-36	47.0	100	3,11
ONKA - 9078	PG-42	55.0	100	3,14
ONKA - 9079	PG-48	60.0	100	3,71

METRİK POLYAMİD KABLO RAKORU (IP-68)



Renkler   
Ral: 7035 7001 9005

ORİNG



KOD	BOY	MON. ÇAPI	K. AD.	KO. AD.	AD. / ʘ	KOD (ORİNG CONTALI)	AD. / ʘ (ORİNG CONTALI)
ONKA - 9050	M 12x1.5	12 mm	450	6750	1,14	ONKA - 9103	1,91
ONKA - 9051	M 16x1.5	16 mm	200	3000	2,05	ONKA - 9104	3,01
ONKA - 9052	M 20x1.5	20 mm	150	2250	2,37	ONKA - 9105	2,44
ONKA - 9053	M 25x1.5	25 mm	75	1125	4,25	ONKA - 9106	5,85
ONKA - 9054	M 32x1.5	32 mm	40	600	6,52	ONKA - 9107	8,09
ONKA - 9055	M 40x1.5	40	20	300	11,87	ONKA - 9108	13,60

METRİK POLYAMİD SOMUN

Renkler   
Ral: 7035 7001 9005

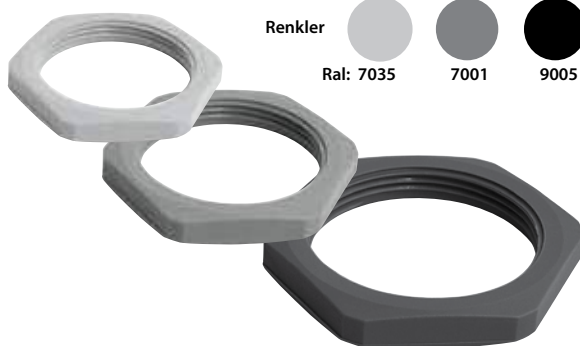

KOD	BOY	MONTAJ DELİK	K. / AD.	AD. / ʘ
ONKA - 9010	M 12 x 1.5	12	250	0,59
ONKA - 9013	M 16 x 1.5	16	250	0,32
ONKA - 9016	M 20 x 1.5	20	250	0,40
ONKA - 9020	M 25 x 1.5	25	250	0,75
ONKA - 9023	M 32 x 1.5	32	250	1,46
ONKA - 9026	M 40 x 1.5	40	250	1,93

PG SİRİRAL KABLO RAKORU (IP-68)



Ral: 7001



Ral: 7035



Ral: 9005

KOD	BOY	MONTAJ ÇAPI	AD. / ʘ	K. / AD.
ONKA - 9275	PG 7	12	1,52	200
ONKA - 9281	PG 11	16	2,40	100
ONKA - 9284	PG 13.5	20	3,02	80
ONKA - 9290	PG 21	25	6,20	30
ONKA - 9276	PG 7	12	1,52	200
ONKA - 9282	PG 11	16	2,40	100
ONKA - 9285	PG 13.5	20	3,02	80
ONKA - 9291	PG 21	25	6,20	30
ONKA - 9277	PG 7	12	1,52	200
ONKA - 9283	PG 11	16	2,40	100
ONKA - 9286	PG 13.5	20	3,02	80
ONKA - 9292	PG 21	25	6,20	30

METRİK SİRİRAL KABLO RAKORU (IP-68)



Ral: 7001



Ral: 7035



Ral: 9005

KOD	BOY	MONTAJ ÇAPI	AD. / ʘ	K. / AD.
ONKA - 9475	M 12 x1.5	12	1,48	200
ONKA - 9478	M 16 x1.5	16	2,48	100
ONKA - 9481	M 20 x 1.5	20	2,86	80
ONKA - 9484	M 25 x 1.5	25	6,22	30
ONKA - 9476	M 12 x1.5	12	1,48	200
ONKA - 9479	M 16 x1.5	16	2,48	100
ONKA - 9482	M 20 x 1.5	20	2,86	80
ONKA - 9485	M 25 x 1.5	25	6,22	30
ONKA - 9477	M 12 x1.5	12	1,48	200
ONKA - 9480	M 16 x1.5	16	2,48	100
ONKA - 9483	M 20 x 1.5	20	2,86	80
ONKA - 9486	M 25 x 1.5	25	6,22	30

PG ETANJ PİRİNÇ KABLO RAKOR NİKEL (SOMUNLU) (IP-68)



KOD	BOY	İÇİNDEN GEÇEN KABLO ÇAPI / mm	MONTAJ ÇAPI	AD. / ʘ	K. / AD.
REK.06.412	PG-7	3 - 6,5	12,5	ʘ	50
REK.06.416	PG-9	4 - 8	15,5		50
REK.06.418	PG-11	5 - 10	19		50
REK.06.420	PG-13.5	6 - 12	20,5		50
REK.06.425	PG-16	10 - 14	22,5		50
REK.06.432	PG-21	13 - 18	28,5		25
REK.06.440	PG-29	18 - 25	37,5		20
REK.06.450	PG-36	22 - 32	47		10
REK.06.456	PG-42	30 - 38	55		10
REK.06.462	PG-48	30 - 38	60		10

METRİK ETANJ PİRİNÇ KABLO RAKOR NİKEL (SOMUNLU) (IP-68)



KOD	BOY	İÇİNDEN GEÇEN KABLO ÇAPI / mm	MONTAJ ÇAPI	AD. / ʘ	K. / AD.
REK.06.012	M12x1,5	3 - 6,5	12	ʘ	50
REK.06.016	M16x1,5	4 - 8	16		50
REK.06.020	M20x1,5	6 - 12	20		50
REK.06.025	M25x1,5	10 - 14	25		50
REK.06.032	M32x1,5	13 - 18	32		25
REK.06.040	M40x1,5	18 - 25	40		25
REK.06.050	M50x1,5	22 - 32	50		10
REK.06.056	M56x1,5	30 - 38	56		10
REK.06.063	M63x1,5	30 - 38	63		10

PLASTİK SİRALLER (SİYAH)



KOD	çinsi	AD./t	M. AD.
M-020 400014 00 11	Ø 14	📞	100
M-020 400016 00 11	Ø 16		100
M-020 400018 00 11	Ø 18		50
M-020 400020 00 11	Ø 20		50
M-020 400026 00 11	Ø 26		50
M-020 400032 00 11	Ø 32		50
M-020 400040 00 11	Ø 40		25
M-020 400050 00 11	Ø 50		25

POLYAMİD (PA6) SİRAL BORU



Kod	Ölçü	Renk	İç Çap (mm)	Dış Çap (mm)	A.Miktarı (mt)	Adet (mt.)
İRPA6-07	PA7	Gri - Siyah / Black - Grey	6,5	10,0	100	📞
İRPA6-8,5	PA8,5	Gri - Siyah / Black - Grey	8,5	12,0	100	
İRPA6-10	PA10	Gri - Siyah / Black - Grey	10,0	13,0	100	
İRPA6-12	PA12	Gri - Siyah / Black - Grey	12,0	16,0	50	
İRPA6-14	PA14	Gri - Siyah / Black - Grey	14,0	18,5	50	
İRPA6-17	PA17	Gri - Siyah / Black - Grey	17,0	21,5	50	
İRPA6-19	PA19	Gri - Siyah / Black - Grey	19,0	24,0	50	
İRPA6-22	PA22	Gri - Siyah / Black - Grey	22,0	27,5	50	
İRPA6-23	PA23	Gri - Siyah / Black - Grey	23,0	28,7	50	
İRPA6-26	PA26	Gri - Siyah / Black - Grey	26,0	31,0	25	
İRPA6-29	PA29	Gri - Siyah / Black - Grey	29,0	34,5	25	
İRPA6-36	PA36	Gri - Siyah / Black - Grey	36,0	42,5	25	
İRPA6-48	PA48	Gri - Siyah / Black - Grey	48,0	54,5	25	

POLİPROPİLEN (pp) SİRAL BORU



KOD	Ölçü	Renk	İç Çap (mm)	Dış Çap (mm)	A.Miktarı (mt)	Adet (mt.)
İRPP-07	PP7	Gri - Siyah / Black - Grey	6,5	10,0	100	📞
İRPP-8,5	PP8,5	Gri - Siyah / Black - Grey	8,5	12,0	100	
İRPP-10	PP10	Gri - Siyah / Black - Grey	10,0	13,0	100	
İRPP-12	PP12	Gri - Siyah / Black - Grey	12,0	16,0	50	
İRPP-14	PP14	Gri - Siyah / Black - Grey	14,0	18,5	50	
İRPP-17	PP17	Gri - Siyah / Black - Grey	17,0	21,5	50	
İRPP-19	PP19	Gri - Siyah / Black - Grey	19,0	24,0	50	
İRPP-22	PP22	Gri - Siyah / Black - Grey	22,0	27,5	50	
İRPP-23	PP23	Gri - Siyah / Black - Grey	23,0	28,7	50	
İRPP-26	PP26	Gri - Siyah / Black - Grey	26,0	31,0	50	
İRPP-29	PP29	Gri - Siyah / Black - Grey	29,0	34,5	25	
İRPP-36	PP36	Gri - Siyah / Black - Grey	36,0	42,5	25	
İRPP-48	PP48	Gri - Siyah / Black - Grey	48,0	54,5	25	

POLYAMİD (PA6) SİRAL BORU RAKORU (Somunlu)



Kod	Ölçü	Renk	Uygun Spiral	A.Miktarı (mt)	Adet
İRAGP-07	PG7	Gri-Siyah/Black-Grey	PA8,5	50	📞
İRAGP-09	PG9	Gri-Siyah/Black-Grey	PA10	50	
İRAGP-11	PG11	Gri-Siyah/Black-Grey	PA12	50	
İRAGP-13	PG13,5	Gri-Siyah/Black-Grey	PA14	50	
İRAGP-16	PG16	Gri-Siyah/Black-Grey	PA17	50	
İRAGP-21	PG21	Gri-Siyah/Black-Grey	PA23	25	
İRAGP-29	PG29	Gri-Siyah/Black-Grey	PA29	20	
İRAGM-16	M16x1,5	Gri-Siyah/Black-Grey	PA12	50	
İRAGM-20	M20x1,5	Gri-Siyah/Black-Grey	PA17	50	
İRAGM-25	M25x1,5	Gri-Siyah/Black-Grey	PA23	25	
İRAGM-32	M32x1,5	Gri-Siyah/Black-Grey	PA29	20	

POLYAMİD (PA6) SİRAL BORU RAKORU 90° (Som.)



Kod	Ölçü	Renk	Uygun Spiral	A.Miktarı (mt)	Adet
İRAGP90-07	PG7	Gri-Siyah/Black-Grey	PA8,5	25	📞
İRAGP90-09	PG9	Gri-Siyah/Black-Grey	PA10	25	
İRAGP90-11	PG11	Gri-Siyah/Black-Grey	PA12	25	
İRAGP90-13	PG13,5	Gri-Siyah/Black-Grey	PA14	25	
İRAGP90-16	PG16	Gri-Siyah/Black-Grey	PA17	25	
İRAGP90-21	PG21	Gri-Siyah/Black-Grey	PA23	25	
İRAGP90-29	PG29	Gri-Siyah/Black-Grey	PA29	10	
İRAGP90-36	PG36	Gri-Siyah/Black-Grey	PA36	10	
İRAGP90-48	PG48	Gri-Siyah/Black-Grey	PA48	10	

GEÇMELİ TİP POLYAMİD SİRAL BORU RAKORU PG



Kod	Ölçü	Renk	Uygun Spiral	A.Miktarı (mt)	Adet
İRPG0707	PG7	Gri-Siyah/Black-Grey	PA8,5	100	📞
İRPG0910	PG9	Gri-Siyah/Black-Grey	PA10	50	
İRPG1112	PG11	Gri-Siyah/Black-Grey	PA12	50	
İRPG1314	PG13,5	Gri-Siyah/Black-Grey	PA14	50	
İRPG1617	PG16	Gri-Siyah/Black-Grey	PA17	50	
İRPG2123	PG21	Gri-Siyah/Black-Grey	PA23	25	
İRPG2929	PG29	Gri-Siyah/Black-Grey	PA29	25	
İRPG3636	PG36	Gri-Siyah/Black-Grey	PA36	10	
İRPG4848	PG48	Gri-Siyah/Black-Grey	PA48	10	

POLYAMİD (PA6) SİRAL BORU KLİPSİ



Kod	Ölçü	Renk	Uygun Spiral	A.Miktarı (mt)	Adet
İRTK-07	PG7	Gri-Siyah/Black-Grey	PA8,5	100	📞
İRTK-09	PG9	Gri-Siyah/Black-Grey	PA10	100	
İRTK-11	PG11	Gri-Siyah/Black-Grey	PA12	100	
İRTK-13	PG13,5	Gri-Siyah/Black-Grey	PA14	50	
İRTK-16	PG16	Gri-Siyah/Black-Grey	PA17	50	
İRTK-21	PG21	Gri-Siyah/Black-Grey	PA23	50	
İRTK-29	PG29	Gri-Siyah/Black-Grey	PA29	25	
İRTK-36	PG36	Gri-Siyah/Black-Grey	PA36	25	
İRTK-48	PG48	Gri-Siyah/Black-Grey	PA48	25	



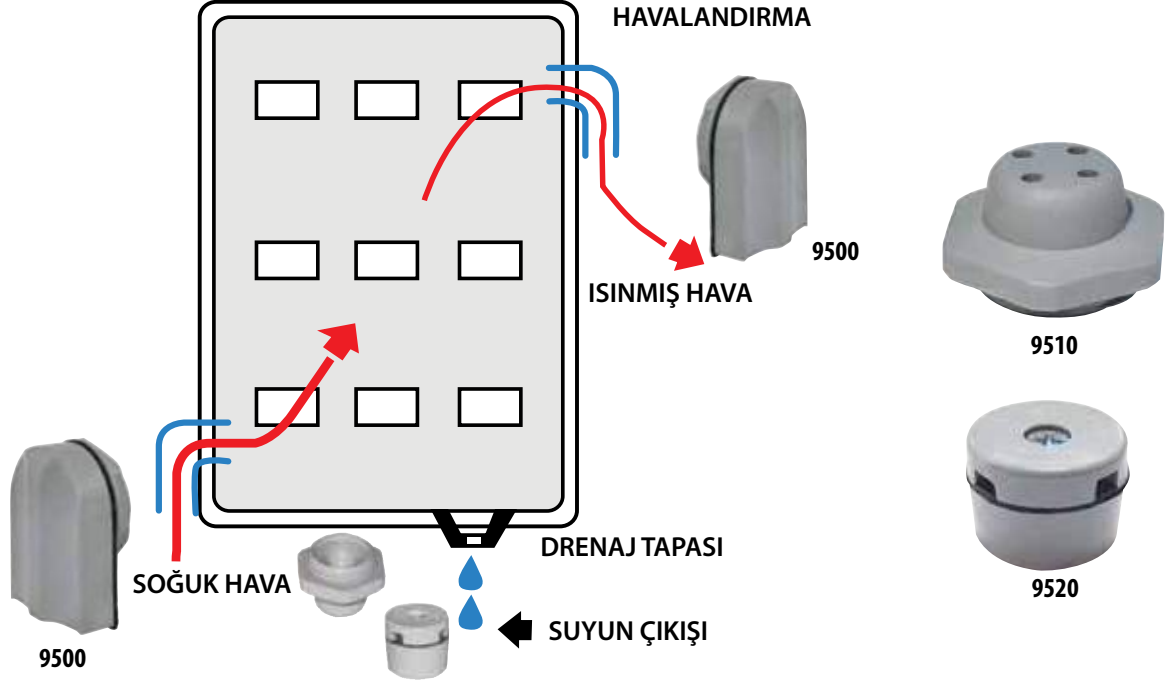

M40 x 1.5 PANO HAVALANDIRMA APARATI (YAPIŞKANLI ve SOMUNLU)

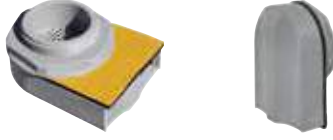

KOD	BOY	AD. / ₺	K. AD.
● ONKA - 9500	M 40 x 1.5	10,00	50
● ONKA - 9501	M 40 x 1.5	10,00	50
● ONKA - 9502	M 40 x 1.5	10,00	50

M25 x 1.5 DRENAJ TAPASI



KOD	BOY	AD. / ₺	K. AD.
● ONKA - 9510	25 x 1.5	1,67	100
● ONKA - 9511	25 x 1.5	1,67	100
● ONKA - 9512	25 x 1.5	1,67	100

Ø16 DRENAJ TAPASI



KOD	BOY (Delme Çapı)	AD. / ₺	K. AD.
● ONKA - 9520	Ø 16	3,37	100
● ONKA - 9521	Ø 16	3,37	100
● ONKA - 9522	Ø 16	3,37	100

PG POLYAMİD KÖRTAPA



KOD	BOY	MONTAJ DELİK	AD. / ₺	K. / AD.
ONKA-9090	PG-7	12.5	⌚	250
ONKA-9091	PG-9	15.5	⌚	250
ONKA-9092	PG-11	18.5	0,60	250
ONKA-9093	PG-13.5	20.5	0,73	250
ONKA-9094	PG-16	22.5	0,90	250
ONKA-9095	PG-21	28.5	0,93	250
ONKA-9096	PG-29	37.5	⌚	150
ONKA-9097	PG-36	47.5	⌚	100

KAUÇUK KÖRTAPA



KOD	BOY	MONTAJ ÇAPI	AD. / ₺	K. / AD.
ONKA-9490	PG-13.5	17	0,95	
ONKA-9491	PG-16	22.8	1,10	
ONKA-9492	PG-21	28.6	1,35	
ONKA-9493	PG-29	37.3	1,90	
ONKA-9494	PG-36	47	2,95	
ONKA-9495	PG-42	55	⌚	50

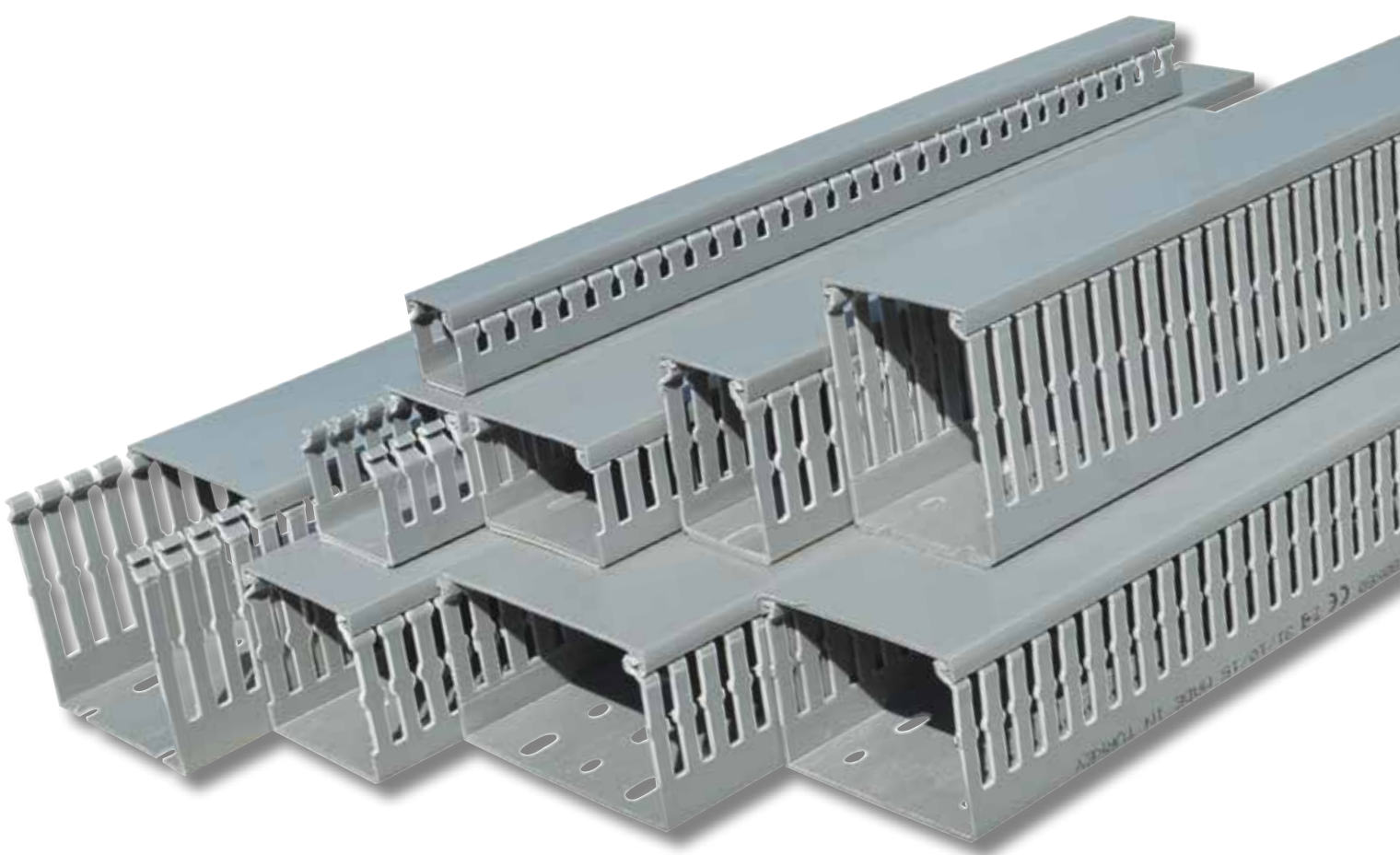

KABLO KANALLARI

Pano İçi Kablo Kanalları



Alternatif renkler için 

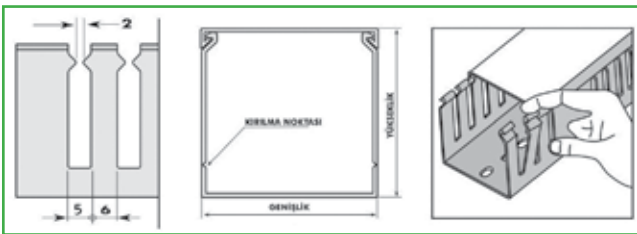

- Yüksek darbeye dayanıklı sert PVC malzeme
- -15 °C +70 °C arası sıcaklık dayanımı
- UL94V0 yanmazlık standardı
- Kolay kapanabilen kapak sistemi
- Yan tırnaklarda kesikler sayesinde kolay kırılabilme imkanı
- 2 m standart boy
- 390 kg/cm gerilme gücü
- Renk RAL 7030 (Gri)



PANO İÇİ DELİKLİ KABLO KANALI (GRİ)



KOD	EBAT (w x h) (Genişlik x Derinlik)	m / ̸	HALOJEN FREE KODU	HALOJEN FREE m / ̸	KUTU / M.
ONKA-7180	25 x 30 mm	14,03	ONKA-7310	18,51	84
ONKA-7181	25 x 40 mm	14,76	ONKA-7311	19,57	84
ONKA-7182	25 x 60 mm	17,69	ONKA-7312	23,89	48
ONKA-7183	40 x 40 mm	17,59	ONKA-7313	23,54	60
ONKA-7184	40 x 60 mm	20,86	ONKA-7314	28,07	36
ONKA-7186	40 x 80 mm	23,34	ONKA-7315	31,73	40
ONKA-7177	60 x 40 mm	22,73	ONKA-7316	30,68	40
ONKA-7185	60 x 60 mm	28,25	ONKA-7317	32,21	24
ONKA-7188	60 x 80 mm	30,84	ONKA-7318	41,47	24
ONKA-7187	80 x 60 mm	32,76	ONKA-7319	44,56	24
ONKA-7178	80 x 80 mm	36,97	ONKA-7320	50,47	24
ONKA-7179	100 X 60 mm	37,69	ONKA-7321	51,25	24

PANO İÇİ DELİKLİ KABLO KANALI (GRİ YAPIŞKANLI)

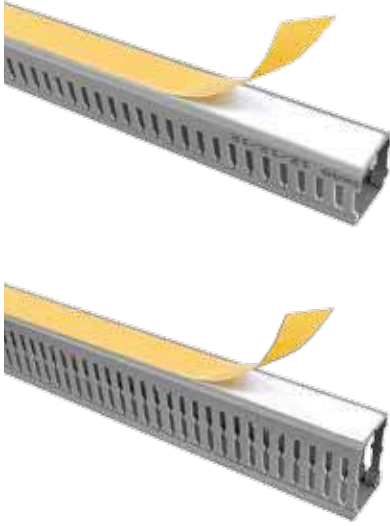

KOD	EBAT (w x h) (Genişlik x Derinlik)	m / ̸	HALOJEN FREE KODU	HALOJEN FREE m / ̸	KUTU / M.
ONKA-7220	25 x 30 mm	13,04	ONKA-7380	19,64	84
ONKA-7221	25 x 40 mm	13,77	ONKA-7381	20,70	84
ONKA-7222	25 x 60 mm	17,01	ONKA-7382	25,02	48
ONKA-7223	40 x 40 mm	17,35	ONKA-7383	25,52	60
ONKA-7224	40 x 60 mm	20,57	ONKA-7384	30,04	36
ONKA-7225	40 x 80 mm	23,25	ONKA-7385	33,71	40
ONKA-7226	60 x 40 mm	23,24	ONKA-7386	33,62	40
ONKA-7227	60 x 60 mm	28,43	ONKA-7387	41,15	24
ONKA-7228	60 x 80 mm	30,87	ONKA-7388	44,70	24
ONKA-7229	80 x 60 mm	34,00	ONKA-7389	48,85	24
ONKA-7230	80 x 80 mm	38,06	ONKA-7390	54,76	24
ONKA-7231	100 X 60 mm	39,50	ONKA-7391	56,61	24

DELİKLİ GRİ KABLO KANALI KAPAKLARI



KOD	GENİŞLİK	m / ̸	HALOJEN FREE KODU	HALOJEN FREE m / ̸	KUTU / M.
ONKA-7290	25 mm	3,92	ONKA-7295	5,13	140
ONKA-7291	40 mm	4,57	ONKA-7296	6,14	80
ONKA-7292	60 mm	8,09	ONKA-7297	10,78	50
ONKA-7293	80 mm	9,29	ONKA-7298	12,35	50
ONKA-7294	100 mm	11,34	ONKA-7299	15,30	40

MEKANİK PVC KANALET MAKASI



KOD	MAX. KESME (EN)	CETVEL BOY AYARI	AĞIRLIK	EBATLAR	AD. / ̸
ŞAFA - PKM 125	125 mm	50 cm	6,00 kg	22 x 59 x 63 cm	2.352,00
ONKA-KKM	60 mm Köşe Makası	-	-	-	Ⓢ

Onka®



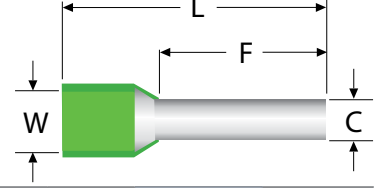

RENK NÖRMLERİ		
FRANSIZ	ALMAN	DIN

	KOD	KABLO KESİTİ (mm ²)	F	L	C	W	AD. / ʘ	K. AD.
ST	ONKA - 8005	0.34	8.0	12.0	0.80	1.9	0,165	1.000
	ONKA - 8006	0.50	6.0	12.0	1.00	2.6	0,082	1.000
ST	ONKA - 8007	0.50	8.0	14.0	1.00	2.6	0,042	1.000
	ONKA - 8008	0.50	10.0	16.0	1.00	2.6	0,126	1.000
	ONKA - 8009	0.75	6.0	12.0	1.20	2.8	0,082	1.000
ST	ONKA - 8010	0.75	8.0	14.0	1.20	2.8	0,042	1.000
	ONKA - 8011	0.75	10.0	16.0	1.20	2.8	0,126	1.000
	ONKA - 8012	0.75	12.0	18.0	1.20	2.8	0,156	1.000
	ONKA - 8013	1.00	6.0	12.0	1.40	3.0	0,082	1.000
ST	ONKA - 8014	1.00	8.0	14.0	1.40	3.0	0,044	1.000
	ONKA - 8015	1.00	10.0	16.0	1.40	3.0	0,126	1.000
	ONKA - 8016	1.00	12.0	18.0	1.40	3.0	0,156	1.000
ST	ONKA - 8017	1.50	8.0	14.0	1.70	3.5	0,050	500
	ONKA - 8018	1.50	10.0	16.0	1.70	3.5	0,156	500
	ONKA - 8019	1.50	12.0	18.0	1.70	3.5	0,186	500
	ONKA - 8020	1.50	18.0	24.0	1.70	3.5	0,216	500
ST	ONKA - 8021	2.50	8.0	14.0	2.20	4.2	0,060	500
	ONKA - 8022	2.50	10.0	16.0	2.20	4.2	0,183	500
	ONKA - 8023	2.50	12.0	18.0	2.20	4.2	0,222	500
	ONKA - 8024	2.50	18.0	24.0	2.20	4.2	0,243	500
ST	ONKA - 8025	4.00	10.0	17.0	2.80	4.8	0,081	200
	ONKA - 8026	4.00	12.0	20.0	2.80	4.8	0,234	200
	ONKA - 8027	4.00	18.0	26.0	2.80	4.8	0,291	200
ST	ONKA - 8028	6.00	12.0	20.0	3.50	6.3	0,116	200
	ONKA - 8029	6.00	18.0	26.0	3.50	6.3	0,408	200
ST	ONKA - 8030	10	12.0	22.0	4.50	7.6	0,176	100
	ONKA - 8031	10	18.0	28.0	4.50	7.6	0,612	100
ST	ONKA - 8032	16	12.0	24.0	5.80	8.8	0,216	100
	ONKA - 8033	16	18.0	28.0	5.80	8.8	0,819	75
ST	ONKA - 8034	25	16.0	30.0	7.30	11.2	0,432	50
	ONKA - 8156	25	18.0	32.0	7.30	11.2	1,260	50
	ONKA - 8035	25	22.0	36.0	7.30	11.2	1,260	50
ST	ONKA - 8036	35	16.0	30.0	8.30	12.7	0,513	50
	ONKA - 8037	35	18.0	32.0	8.30	12.7	1,440	25
	ONKA - 8038	35	25.0	39.0	8.30	12.7	1,578	25
ST	ONKA - 8039	50	20.0	36.0	10.30	15.0	0,999	25
	ONKA - 8040	50	25.0	40.0	10.30	15.0	2,340	25
	ONKA - 8041	70	21.0	37.0	13.50	16.0	1,485	10
	ONKA - 8042	95	25.0	44.0	14.70	18.0	8,190	10
	ONKA - 8043	120	27.0	48.0	16.70	20.0	9,930	10
	ONKA - 8044	150	32.0	58.0	19.50	23.0	15,09	10



DIN 46228 Standartı,

Bakır Malzemeden Kalay Kaplı,

Polyamid İzoleli,

-40 °C + 105 °C Çalışma Sıcaklığı

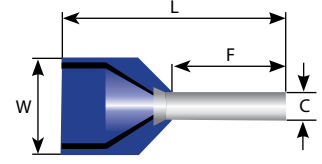

KUTULU SERİ İZOLELİ ÇİFT GİRİŞLİ KABLO YÜKSÜKLERİ DIN 46228

RENK NORMLARI		
FRANSIZ	ALMAN	DIN

KOD	KABLO KESİTİ (mm ²)	F	L	C	W	AD. / ʘ	K. AD.
ONKA - 8161	2 x 0.50	8.0	15.0	1.5	2.5 / 4.7	0,067	500
ONKA - 8162	2 x 0.75	8.0	15.0	1.8	2.8 / 5.0	0,067	500
ONKA - 8163	2 x 0.75	10.0	17.0	1.8	2.8 / 5.0	0,252	500
ONKA - 8164	2 x 1.0	8.0	15.0	2.05	3.4 / 5.4	0,069	500
ONKA - 8165	2 x 1.0	10.0	17.0	2.05	3.4 / 5.4	0,252	500
ONKA - 8166	2 x 1.5	8.0	16.0	2.3	3.6 / 6.6	0,073	500
ONKA - 8528	2 x 1.5	10.0	16.0	2.3	3.6 / 6.6	0,294	500
ONKA - 8167	2 x 1.5	12.0	20.0	2.3	3.6 / 6.6	0,315	500
ONKA - 8168	2 x 2.5	10.0	18.5	2.8	4.2 / 7.8	0,117	250
ONKA - 8169	2 x 2.5	13.0	21.5	2.8	4.2 / 7.8	0,429	250
ONKA - 8170	2 x 4.0	12.0	23.0	3.7	4.9 / 8.8	0,162	100
ONKA - 8171	2 x 6.0	14.0	26.0	4.8	6.9 / 10.0	0,230	100
ONKA - 8172	2 x 10.0	14.0	26.5	6.4	7.6 / 12.8	0,351	50
ONKA - 8173	2 x 16.0	14.0	31.5	8.3	9.6 / 18.6	0,527	50

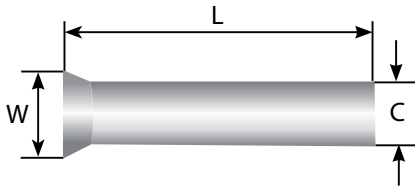

KOD	KABLO KESİTİ (mm ²)	L	C	W	AD. / ʘ	K. AD.
ONKA - 8100	0.50	6.0	1.0	2.1	0,069	1.000
ONKA - 8101	0.50	8.0	1.0	2.1	0,069	1.000
ONKA - 8102	0.50	10.0	1.0	2.1	0,034	1.000
ONKA - 8103	0.75	6.0	1.2	2.3	0,069	1.000
ONKA - 8104	0.75	8.0	1.2	2.3	0,069	1.000
ONKA - 8105	0.75	10.0	1.2	2.3	0,040	1.000
ONKA - 8107	1.0	8.0	1.4	2.5	0,072	1.000
ONKA - 8108	1.0	10.0	1.4	2.5	0,0351	1.000
ONKA - 8109	1.0	12.0	1.4	2.5	0,084	1.000
ONKA - 8111	1.5	8.0	1.7	2.8	0,084	1.000
ONKA - 8112	1.5	10.0	1.7	2.8	0,041	1.000
ONKA - 8113	1.5	12.0	1.7	2.8	0,093	1.000
ONKA - 8115	2.5	8.0	2.2	3.4	0,099	1.000
ONKA - 8116	2.5	10.0	2.2	3.4	0,114	1.000
ONKA - 8117	2.5	12.0	2.2	3.4	0,049	1.000
ONKA - 8118	4.0	8.0	2.8	4.0	0,147	1000
ONKA - 8120	4.0	10.0	2.8	4.0	0,147	1000
ONKA - 8121	4.0	12.0	2.8	4.0	0,072	1000
ONKA - 8122	4.0	15.0	2.8	4.0	0,231	1000
ONKA - 8123	4.0	18.0	2.8	4.0	0,252	1000
ONKA - 8124	6.0	10.0	3.5	4.7	0,198	500
ONKA - 8125	6.0	12.0	3.5	4.7	0,097	500
ONKA - 8126	6.0	15.0	3.5	4.7	0,273	500
ONKA - 8127	6.0	18.0	3.5	4.7	0,357	500
ONKA - 8128	10.0	12.0	4.5	5.8	0,142	200
ONKA - 8129	10.0	15.0	4.5	5.8	0,387	200
ONKA - 8130	10.0	18.0	4.5	5.8	0,420	200
ONKA - 8131	16.0	12.0	5.8	7.5	0,162	100
ONKA - 8132	16.0	15.0	5.8	7.5	0,408	100
ONKA - 8133	16.0	18.0	5.8	7.5	0,462	100
ONKA - 8134	25.0	15.0	7.3	9.5	0,660	100
ONKA - 8135	25.0	16.0	7.3	9.5	0,324	100
ONKA - 8136	25.0	18.0	7.3	9.5	0,882	100
ONKA - 8137	25.0	22.0	7.3	9.5	1,050	100
ONKA - 8138	35.0	16.0	8.3	11.0	0,378	75
ONKA - 8139	35.0	18.0	8.3	11.0	1,092	75
ONKA - 8140	35.0	20.0	8.3	11.0	1,206	75
ONKA - 8141	35.0	25.0	8.3	11.0	1,533	75
ONKA - 8142	50.0	18.0	10.3	13.0	1,533	25
ONKA - 8143	50.0	20.0	10.3	13.0	0,756	25
ONKA - 8144	50.0	25.0	10.3	13.0	2,352	25
ONKA - 8146	70.0	25.0	13.5	15.3	3,906	10
ONKA - 8148	95.0	25.0	14.7	16.6	5,565	10
ONKA - 8151	120.0	32.0	16.7	18.0	8,610	10
ONKA - 8153	150.0	32.0	19.5	21.5	13,65	10

DIN 46228 Standartı,
Bakır Malzemedden Kalay Kaplı

İZOLELİ YUVARLAK KABLO UÇLARI

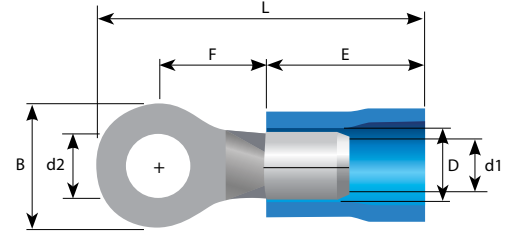

DIN 46237 Standartı, Bakır Malzemeden Kalay Kaplı, PVC İzoleli, 105 °C Çalışma Sıcaklığı, 600 Volt Enerjiye Dayanabilir.

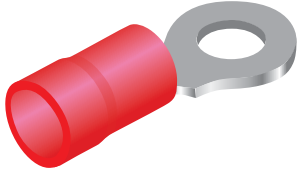

0,5 ~ 1,5 mm², Kablo Kesiti

KOD	METRİK ÖLÇÜ (d2)	B	L	F	E	D	d1	AD. / ı	K. AD.
ONKA-8045 -R1-3 V	3.2	5.5	16.7	4.0	10.0	4.1	1.7	0,195	200
ONKA-8047-R1-3.5 MV	3.7	6.6	19.6	6.3	10.0	4.1	1.7	0,195	200
ONKA-8049-R1-4 SV	4.3	6.6	19.6	6.3	10.0	4.1	1.7	0,198	200
ONKA-8050-R1-4 LV	4.3	8.0	21.0	7.0	10.0	4.1	1.7	0,597	200
ONKA-8051-R1-5 V	5.3	8.0	21.0	7.0	10.0	4.1	1.7	0,210	200
ONKA-8052-R1-6 V	6.5	11.6	26.8	11.1	10.0	4.1	1.7	0,345	200
ONKA-8053-R1-8 V	8.4	11.6	26.8	11.1	10.0	4.1	1.7	0,345	200
ONKA-8054-R1-10 V	10.5	13.6	30.7	13.9	10.0	4.1	1.7	1,050	100
ONKA-8055-R1-12 V	13	19.2	35.6	16.0	10.0	4.1	1.7	1,605	100

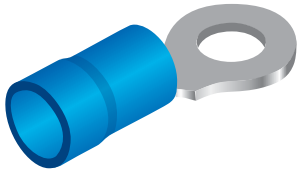

1,5 ~ 2,5 mm², Kablo Kesiti

ONKA-8056-R2-3 V	3.2	6.4	17.5	4.3	10.0	4.5	2.3	0,222	200
ONKA-8058-R2-3.5 MV	3.7	6.6	19.5	6.3	10.0	4.5	2.3	0,681	200
ONKA-8059-R2-3.5 LV	3.7	8.5	22.0	7.8	10.0	4.5	2.3	0,702	200
ONKA-8060-R2-4 SV	4.3	6.6	19.5	6.3	10.0	4.5	2.3	0,225	200
ONKA-8086-R2-4 LV	4.3	8.5	22.0	7.8	10.0	4.5	2.3	0,702	200
ONKA-8087-R2-5 SV	5.3	8.5	22.0	7.8	10.0	4.5	2.3	0,260	200
ONKA-8088-R2-5 LV	5.3	9.5	22.0	7.3	10.0	4.5	2.3	0,735	200
ONKA-8089-R2-6 V	6.5	12.0	27.0	11.0	10.0	4.5	2.3	0,372	200
ONKA-8090-R2-8 V	8.4	12.0	27.0	11.0	10.0	4.5	2.3	0,375	200
ONKA-8091-R2-10 V	10.5	13.6	30.7	13.9	10.0	4.5	2.3	0,420	100
ONKA-8092-R2-12 V	13.0	19.2	35.6	16.0	10.0	4.5	2.3	2,016	100



4,0 ~ 6,0 mm², Kablo Kesiti

ONKA-8093-R5-4 SV	4.3	7.2	22.0	5.9	12.5	6.5	3.4	0,450	75
ONKA-8094-R5-4 LV	4.3	9.5	25.5	8.3	12.5	6.5	3.4	1,281	75
ONKA-8095-R5-5 V	5.3	9.5	25.5	8.3	12.5	6.5	3.4	0,522	75
ONKA-8096-R5-6 V	6.5	12.0	29.0	10.5	12.5	6.5	3.4	0,567	75
ONKA-8097-R5-8 V	8.4	15.0	33.7	13.7	12.5	6.5	3.4	0,774	75
ONKA-8098-R5-10 V	10.5	15.0	33.7	13.7	12.5	6.5	3.4	0,780	75
ONKA-8099-R5-12 V	13.0	19.2	38.1	16.0	12.5	6.5	3.4	0,930	75

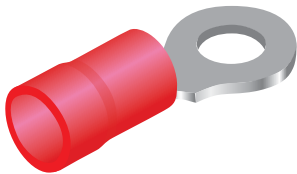

8,0 ~ 10,0 mm², Kablo Kesiti

ONKA-8158-R8-4 LV	4.3	12.0	32.5	9.7	17.0	8.0	4.5	3,045	50
ONKA-8159-R8-5 MV	5.3	12.0	32.5	9.7	17.0	8.0	4.5	1,122	50
ONKA-8160-R8-6 SV	6.7	12.0	32.5	9.7	17.0	8.0	4.5	1,125	50
ONKA-8174-R8-5 LV	5.3	15.0	38.0	13.8	17.0	8.0	4.5	3,360	50
ONKA-8175-R8-6 LV	6.7	15.0	38.0	13.8	17.0	8.0	4.5	3,570	50
ONKA-8176-R8-8 V	8.4	15.0	38.0	13.8	17.0	8.0	4.5	3,780	50
ONKA-8177-R8-10 V	10.5	15.0	38.0	13.8	17.0	8.0	4.5	3,990	50

İZOLELİ ÇATAL TİP KABLO UÇLARI

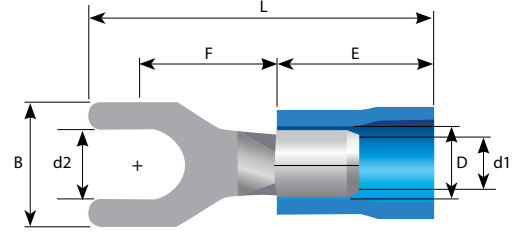

DIN 46237 Standartı, Bakır Malzemedен Kalay Kaplı, PVC İzoleli, 105 °C Çalışma Sıcaklığı, 600 Volt Enerjiye Dayanabilme.

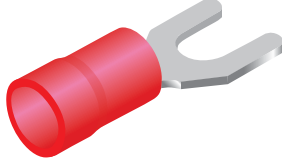

0,5 ~ 1,5 mm², Kablo Kesiti

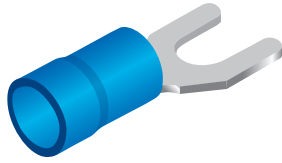

1,5 ~ 2,5 mm², Kablo Kesiti

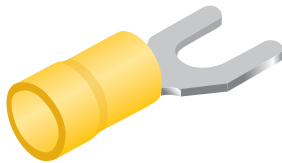

4,0 ~ 6,0 mm², Kablo Kesiti

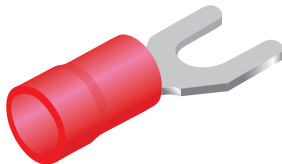

8,0 ~ 10,0 mm², Kablo Kesiti

KOD	METRİK ÖLÇÜ (d2)	B	L	F	E	D	d1	AD. / ı	K. AD.
ONKA - 8061-3 V	3.2	5.8	21.0	6.3	10.0	4.1	1.7	0,195	200
ONKA - 8062-3.5 SV	3.7	6.4	20.6	6.3	10.0	4.1	1.7	0,576	200
ONKA - 8063-3.5 LV	3.7	7.2	21.0	6.3	10.0	4.1	1.7	0,576	200
ONKA - 8064-4 SV	4.3	6.4	20.6	6.3	10.0	4.1	1.7	0,195	200
ONKA - 8065-4 MV	4.3	7.2	21.0	6.3	10.0	4.1	1.7	0,624	200
ONKA - 8066-5 SV	5.3	8.0	21.0	7.0	10.0	4.1	1.7	0,210	200
ONKA - 8067-5 LV	5.3	9.5	21.0	7.0	10.0	4.1	1.7	0,639	200
ONKA - 8068-6 LV	6.5	12.0	27.2	11.0	10.0	4.1	1.7	0,225	200
ONKA - 8069-8 V	8.4	12.0	27.2	11.0	10.0	4.1	1.7	1,122	100
ONKA - 8070-3 V	3.2	5.8	21.0	6.3	10.0	4.5	2.3	0,222	200
ONKA - 8071-3.5 MV	3.7	6.4	21.0	6.3	10.0	4.5	2.3	0,714	200
ONKA - 8072-4 SV	4.3	6.4	21.0	6.3	10.0	4.5	2.3	0,225	200
ONKA - 8073-4 MV	4.3	7.2	21.2	6.5	10.0	4.5	2.3	0,756	200
ONKA - 8074-5 LV	5.3	9.5	22.0	7.2	10.0	4.5	2.3	0,261	200
ONKA - 8075-6 LV	6.5	12.0	27.2	11.0	10.0	4.5	2.3	0,276	200
ONKA - 8076-8 V	8.4	12.0	27.2	11.0	10.0	4.5	2.3	1,140	100
ONKA - 8580 -3.5 SV	3.7	7.2	25.2	7.5	12.5	6.5	3.4	0,630	75
ONKA - 8077-4 SV	4.3	8.5	25.2	7.5	12.5	6.5	3.4	0,462	75
ONKA - 8078-4 LV	4.3	9.5	25.2	7.5	12.5	6.5	3.4	1,035	75
ONKA - 8079-5 V	5.3	9.5	25.2	7.5	12.5	6.5	3.4	0,465	75
ONKA - 8080-6 SV	6.5	9.5	25.2	7.5	12.5	6.5	3.4	0,468	75
ONKA - 8081-6 LV	6.5	12.0	31.2	12.0	12.5	6.5	3.4	1,428	75
ONKA - 8082-8V	8.4	13.5	30.0	10.5	12.5	6.5	3.4	0,759	75
ONKA - 8083-4V	4.3	8.2	29.0	8.1	17.0	8.0	4.5	2,940	50
ONKA - 8084-5V	5.3	9.0	29.0	8.1	17.0	8.0	4.5	3,045	50
ONKA - 8085-6V	6.5	10.8	30.5	8.6	17.0	8.0	4.5	3,108	50

S: Smal

M: Medium

L: Large

PVC İZOLELİ FASTON DIŞI KABLO UCU



EXTRA ÇİFT YÜKSÜKLÜ

Pirinç Malzemedenden Kalay Kaplı,
PVC İzoleli,
75 °C Çalışma Sıcaklığı,
300 Volt Enerjiye Dayanabilme.

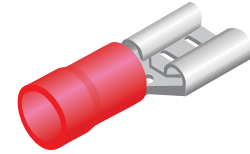
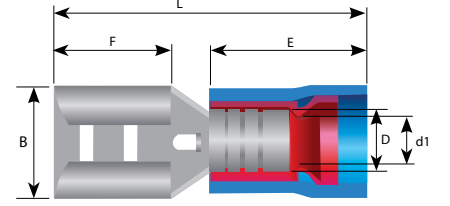

0,5 ~ 1,5 mm², Kablo Kesiti

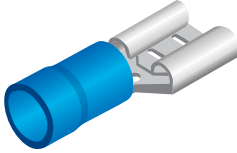

1,5 ~ 2,5 mm², Kablo Kesiti

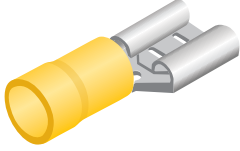

4,0 ~ 6,0 mm², Kablo Kesiti

KOD	SOKET GENİŞLİĞİ	B	F	L	E	D	d1	AD. / ʘ	K. AD.
ONKA - 8230-F1-2.8 VD/5	0.5 x 2.8	3.2	6.4	18.5	10.0	4.3	1.7	0,639	200
ONKA - 8231-F1-2.8 VD/8	0.8 x 2.8	3.2	6.4	18.5	10.0	4.3	1.7	0,630	200
ONKA - 8232-F1-4.8 VD/5	0.5 x 4.8	5.0	6.5	19.0	10.0	4.3	1.7	0,660	200
ONKA - 8233-F1-4.8 VD/8	0.8 x 4.8	5.0	6.5	19.0	10.0	4.3	1.7	0,660	200
ONKA - 8234-F1-6.4 VD	0.8 x 6.4	6.6	7.9	21.0	10.0	4.3	1.7	0,840	200
ONKA - 8235-F1-8 VD	0.8 x 8.0	8.4	10.0	24.0	10.0	4.3	1.7	1,071	200

ONKA - 8236-F2-2.8 VD/5	0.5 x 2.8	3.2	6.4	18.5	10.0	5.0	2.3	0,660	150
ONKA - 8237-F2-2.8 VD/8	0.8 x 2.8	3.2	6.4	18.5	10.0	5.0	2.3	0,639	150
ONKA - 8238-F2-4.8 VD/5	0.5 x 4.8	5.0	6.5	19.0	10.0	5.0	2.3	0,723	150
ONKA - 8239-F2-4.8 VD/8	0.8 x 4.8	5.0	6.5	19.0	10.0	5.0	2.3	0,693	150
ONKA - 8240-F2-6.4 VD	0.8 x 6.4	6.6	7.9	21.0	10.0	5.0	2.3	0,891	150
ONKA - 8241 -F2-8 VD	0.8 x 8.0	8.4	10.0	24.0	10.0	5.0	2.3	1,080	150
ONKA - 8242-F2-9.5 VD	1.2 x 9.5	9.5	12.5	29.0	10.0	5.0	2.3	1,260	150

ONKA - 8243-F5-6.4 VD	0.8 x 6.4	6.6	7.9	23.5	12.5	6.5	3.4	1,134	100
ONKA - 8244-F5-9.5VD	1.2 x 9.5	9.9	12.5	28.5	12.5	6.5	3.4	1,995	100

PVC FULL İZOLELİ FASTON DIŞI KABLO UCU



Pirinç Malzemedenden Kalay Kaplı,
PVC İzoleli,
75 °C Çalışma Sıcaklığı,
300 Volt Enerjiye Dayanabilme.

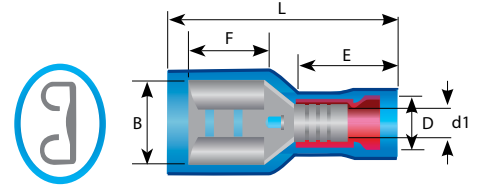

EXTRA ÇİFT YÜKSÜKLÜ

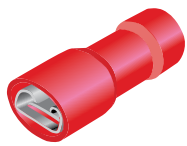

0,5 ~ 1,5 mm², Kablo Kesiti

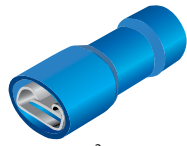

1,5 ~ 2,5 mm², Kablo Kesiti

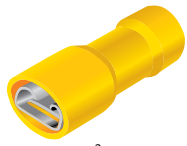

4,0 ~ 6,0 mm², Kablo Kesiti

KOD	SOKET GENİŞLİĞİ	B	F	L	E	D	d1	AD. / ʘ	K. AD.
ONKA - 8250-F1-2.8 VFD-5	0.5 x 2.8	3.2	6.4	19.0	10.0	4.3	1.7	0,819	200
ONKA - 8251-F1-2.8 VFD-8	0.8 x 2.8	3.2	6.4	19.0	10.0	4.3	1.7	0,798	200
ONKA - 8252-F1-4.8 VFD-5	0.5 x 4.8	5.0	6.5	20.0	10.0	4.3	1.7	0,819	200
ONKA - 8253-F1-4.8 VFD-8	0.8 x 4.8	5.0	6.5	20.0	10.0	4.3	1.7	0,798	200
ONKA - 8254-F1-6.4 VFD	0.8 x 6.4	6.6	7.9	22.0	10.0	4.3	1.7	0,954	100

ONKA - 8255-F2-2.8 VFD-5	0.5 x 2.8	3.2	6.4	19.0	10.0	5.0	2.3	0,819	100
ONKA - 8256-F2-2.8 VFD-8	0.8 x 2.8	3.2	6.4	19.0	10.0	5.0	2.3	0,798	100
ONKA - 8257-F2-4.8 VFD-5	0.5 x 4.8	5.0	6.5	20.0	10.0	5.0	2.3	0,819	100
ONKA - 8258-F2-4.8 VFD-8	0.8 x 4.8	5.0	6.5	20.0	10.0	5.0	2.3	0,798	100
ONKA - 8259-F2-6.4 VFD	0.8 x 6.4	6.6	7.9	22.0	10.0	5.0	2.3	0,954	100

ONKA - 8260-F5-6.4 VFD	0.8 x 6.4	6.6	7.9	25.0	13.0	6.5	3.4	1,197	75
------------------------	-----------	-----	-----	------	------	-----	-----	--------------	----

İZOLELİ EKSTRA ÇİFT YÜKSÜKLÜ ERKEK KABLO UCU



Pirinç malzemedен kalay kaplı, PVC izoleli, 75 °C çalışma sıcaklığı, 300 Volt enerjiye dayanabilme özelliğine sahiptir.

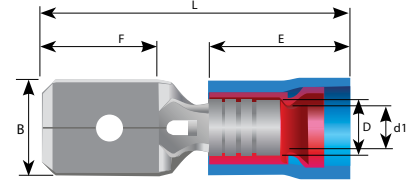

KOD	KABLO KESİTİ	SOKET GENİŞLİĞİ	ÖLÇÜLER (mm)						AD. / ʘ	Kutu Adedi
			B	F	L	E	D	d1		
ONKA-8264-M1 - 2.8 VD/5	0.5~1.5 mm 22~16 AWG	0.5 x 2.8	2.8	7.0	19.2	10.0	4.3	1.7	0,600	200
ONKA-8265-M1 - 2.8 VD/8		0.8 x 2.8	2.8	7.8	20.5				0,588	200
ONKA-8266-M1 - 4.8 VD/5		0.5 x 4.8	4.8	7.0	19.2				0,690	200
ONKA-8267-M1 - 4.8 VD/8		0.8 x 4.8	4.8	7.8	20.5				0,672	200
ONKA-8268-M1 - 6.4 VD		0.8 x 6.4	6.4	7.8	21.2				0,786	200
ONKA-8269-M2 - 2.8 VD/5	1.5~2.5 mm 16~14 AWG	0.5 x 2.8	2.8	7.0	19.2	10.0	5.0	2.3	0,735	200
ONKA-8270-M2 - 2.8 VD/8		0.8 x 2.8	2.8	7.8	20.5				0,723	200
ONKA-8271-M2 - 4.8 VD/5		0.5 x 4.8	4.8	7.0	19.2				0,735	200
ONKA-8272-M2 - 4.8 VD/8		0.8 x 4.8	4.8	7.8	20.5				0,723	200
ONKA-8273-M2 - 6.4 VD		0.8 x 6.4	6.4	7.8	21.2				0,798	200
ONKA-8274-M5 - 6.4 VD	4.0~6.0 mm 12~10 AWG	0.8 x 6.4	6.4	7.8	23.7	12.5	6.5	3.4	1,230	100

POLYAMİD FULL İZOLELİ DİŞİ FASTON KABLO UCU

Pirinç malzemedен kalay kaplı, polyamid izoleli, 105 °C çalışma sıcaklığı, 300 Volt enerjiye dayanabilme özelliğine sahiptir.

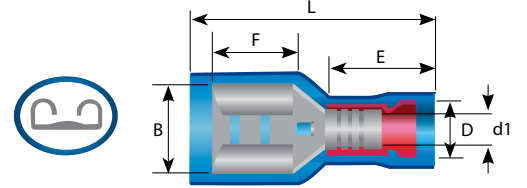

SİPARİŞ KODU	KABLO KESİTLERİ	SOKET GENİŞLİĞİ	ÖLÇÜLER (MM)						RENKLER	AD. / ʘ	KUTU ADEDİ
			B	F	L	E	D	d1			
ONKA - 8529-F1 - 2.8 AFC	0.5 ~ 1.5 mm 22 ~ 16 AWG	0.8x2.8	2.8	19.0	10.5	4.2	1.7	1.7		1,176	100
ONKA - 8261-F1 - 6.4 AFC		0.8x6.4	6.4	22.0	10.5	4.2	1.7	1.7		1,449	100
ONKA - 8262-F2 - 6.4 AFC	1.5 ~ 2.5 mm 16 ~ 14 AWG	0.8 x 6.4	6.4	7.9	22.0	10.5	4.9	2.3		1,449	100
ONKA - 8263-F5 - 6.4 AFC	4.0 ~ 6.0 mm 12 ~ 10 AWG	0.8x6.4	6.4	24.5	13.0	6.5	3.4	3.4		1,890	100

İZOLELİ EK MUFLAR



Pirinç Malzemeden
Kalay Kaplı, PVC İzoleli,
75 °C Çalışma Sıcaklığı,
300 Volt Enerjiye Dayanabilme.



KOD	KABLO KESİTİ (mm ²)	L	d	D	AD. / ʘ	K. AD.
ONKA-8215-BB 1V	0,5 - 1,5	26.0	1.7	4.1	0,681	200
ONKA-8216-BB 2V	1,5 - 2,5	26.0	2.3	4.5	0,765	200
ONKA-8217-BB 5V	4,0 - 6,0	27.0	3.4	6.5	1,323	100

İZOLELİ ŞEFFAF EK MUFLAR



Bakır Malzemeden
Kalay Kaplı, Naylon İzoleli,
150 °C Çalışma Sıcaklığı,
600 Volt Enerjiye Dayanabilme.

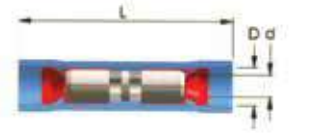

KOD	KABLO KESİTİ (mm ²)	L	d	D	AD. / ʘ	K. AD.
ONKA-8219-BC 0.5A	0,2 - 0,5	20.0	1.0	2.3	0,639	200
ONKA-8220-BC 1A	0,5 - 1,5	26.0	1.8	4.2	0,681	200
ONKA-8221-BC 2A	1,5 - 2,5	26.0	2.4	4.8	0,786	200
ONKA-8222-BC 5A	4,0 - 6,0	27.0	3.6	4.8	1,218	100

ŞEFFAF İZOLELİ DARALAN MAKARONLU EK MUF

Pirinç malzemeden kalay kaplı, PVC izoleli, 75 °C çalışma sıcaklığı, 300 Volt enerjiye dayanabilme özelliğine sahiptir.

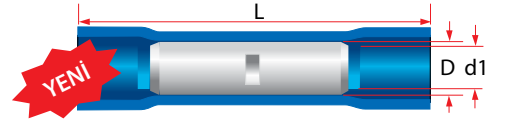

Sipariş Kodu	Kablo Kesitleri	Ölçüler (mm)			Renkler	Kutu Adedi	Adet Fiyatı (\$)
		L	D	d1			
BCT1H	0.5 ~ 1.5 mm 22 ~ 16 AWG	24.0	1.6	0.75		200	0,20 0 USD
BCT2H	1.5 ~ 2.5 mm 16 ~ 14 AWG	37.0	2.3	0.8		200	0,235 USD
BCT5H	4 ~ 6 mm 12 ~ 10 AWG	41.0	3.6	0.9		200	0,325 USD

İZOLESİZ EK MUFLARI

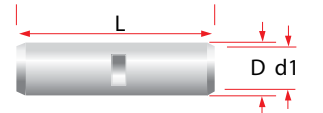

Sipariş Kodu	Kablo Kesitleri	Ölçüler (mm)			Renkler	Kutu Adedi	Adet Fiyatı (\$)
		L	D	d1			
BCT-0.5 N	0.1 ~ 0.5 mm ² 26 ~ 22 AWG	12.0	2.0	1.0		200	0,040 USD
BCT-1N	0.5 ~ 1.5 mm ² 22 ~ 16 AWG	15.0	3.3	1.6		100	0,045 USD
BCT-2N	1.5 ~ 2.5 mm ² 16 ~ 14 AWG	15.0	4.0	2.3		100	0,055 USD
BCT-5N	4.0 ~ 6.0 mm ² 12 ~ 10 AWG	15.0	5.5	3.6		100	0,088 USD
BCT-8N	8 mm ² 8 AWG	21.0	7.0	4.5		100	0,230 USD

EKSTRA ÇİFT LÜ ERKEK, GERİ DÖNÜŞLÜ DİŞİ KABLO UCU



EXTRA ÇİFT YÜKSÜKLÜ

Pirinç Malzemedden Kalay Kaplı,
PVC İzoleli,
75 °C Çalışma Sıcaklığı,
300 Volt Enerjiye Dayanabilme.

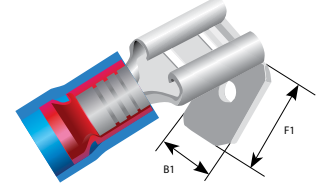
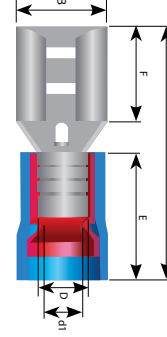

0,5 ~ 1,5 mm², Kablo Kesiti

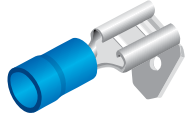

1,5 ~ 2,5 mm², Kablo Kesiti

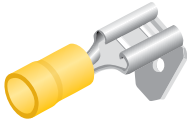

4,0 ~ 6,0 mm², Kablo Kesiti

KOD	SOKET GENİŞLİĞİ	B	B1	F	F1	L	E	D	d1	AD. / ʘ	K. AD.
ONKA - 8280-PB1-6.4 VD	0.8 x 6.4	6.6	6.4	8.0	8.2	21.0	10.0	4.3	1.7	1,281	100

ONKA - 8281-PB2-6.4 VD	0.8 x 6.4	6.6	6.4	8.0	8.2	21.0	10.0	5.0	2.3	1,302	100
------------------------	-----------	-----	-----	-----	-----	------	------	-----	-----	-------	-----

ONKA - 8282-PB5 -6.4 VD	0.8 x 6.4	6.6	6.4	8.0	8.2	23.5	12.5	6.5	3.4	1,575	50
-------------------------	-----------	-----	-----	-----	-----	------	------	-----	-----	-------	----

FULL İZOLELİ EKSTRA ÇİFT YÜKSÜKLÜ ERKEK, GERİ DÖNÜŞLÜ DİŞİ KABLO UCU



EXTRA ÇİFT YÜKSÜKLÜ

Pirinç Malzemedden Kalay Kaplı,
PVC İzoleli,
75 °C Çalışma Sıcaklığı,
300 Volt Enerjiye Dayanabilme.

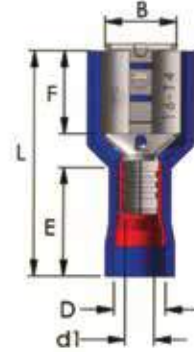

0,5 ~ 1,5 mm², Kablo Kesiti



1,5 ~ 2,5 mm², Kablo Kesiti



4,0 ~ 6,0 mm², Kablo Kesiti

KOD	SOKET GENİŞLİĞİ	B	B1	F	F1	L	E	D	d1	AD. / ʘ	K. AD.
ONKA-8285-PB1-6.4 VFD	0.8 x 6.4	6.6	6.4	8.0	8.2	22.0	10.0	4.3	1.7	1,785	100

ONKA-8286-PB2-6.4 VFD	0.8 x 6.4	6.6	6.4	8.0	8.2	22.0	10.0	5.0	2.3	2,130	100
-----------------------	-----------	-----	-----	-----	-----	------	------	-----	-----	-------	-----

ONKA-8590-PB5-6.4 VFD	0.8 x 6.4	6.6	6.4	8.0	8.2	25.0	13.0	6.5	3.4	2,688	50
-----------------------	-----------	-----	-----	-----	-----	------	------	-----	-----	-------	----

İĞNE TİP PVC İZOLELİ KABLO UÇLARI

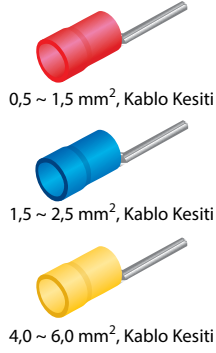
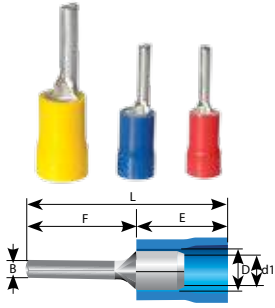

0,5 ~ 1,5 mm², Kablo Kesiti

1,5 ~ 2,5 mm², Kablo Kesiti

4,0 ~ 6,0 mm², Kablo Kesiti

KOD	B	L	F	E	D	d1	AD. / ʘ	K. AD.
ONKA-8186-PT1-10V	1.9	20.5	10.5	10.0	4.1	1.7	0,336	200
ONKA-8187-PT2-10V	1.9	20.5	10.5	10.0	4.5	2.3	0,366	200
ONKA-8188-PT2-12V	1.9	22.5	12.5	10.0	4.5	2.3	0,366	200
ONKA-8189-PT2-18V	1.9	28.5	18.5	10.0	4.5	2.3	0,651	200
ONKA-8190-PT5-13V	2.8	26.2	13.7	12.5	6.5	3.4	0,735	100

Bakır malzemeden, kalay kaplı, PVC izoleli, 75 °C çalışma sıcaklığı, 600 Volt enerjiye dayanabilme.

BIÇAK TİP PVC İZOLELİ KABLO UÇLARI

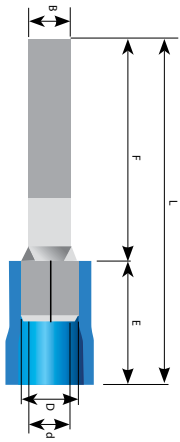

0,5 ~ 1,5 mm², Kablo Kesiti

1,5 ~ 2,5 mm², Kablo Kesiti

4,0 ~ 6,0 mm², Kablo Kesiti

KOD	B	L	F	E	D	d1	AD. / ʘ	K. AD.
ONKA-8191-BT1-10A	2.4	21.5	10.5	11.0	4.1	1.7	0,819	100
ONKA-8192-BT1-14A	3.0	22.0	11.0	11.0	4.1	1.7	0,840	100
ONKA-8193-BT1-18A	3.0	25.0	14.0	11.0	4.1	1.7	1,185	100
ONKA-8194-BT2-9A	2.8	20.0	9.0	11.0	4.5	2.3	0,975	100
ONKA-8195-BT2-18A	2.4	29.0	18.0	11.0	4.5	2.3	0,975	100
ONKA-8196-BT5-18A	3.0	31.0	18.0	13.0	6.5	3.4	2,100	100

Bakır malzemeden kalay kaplı, Naylon izoleli, 105 °C çalışma sıcaklığı, 600 Volt enerjiye dayanabilme özelliğine sahiptir.

UCU KIVRIK İZOLELİ BIÇAK TERMİNALLER

Bakır malzemeden kalay kaplı, Naylon izoleli, 105 °C çalışma sıcaklığı, 600 Volt enerjiye dayanabilme özelliğine sahiptir.

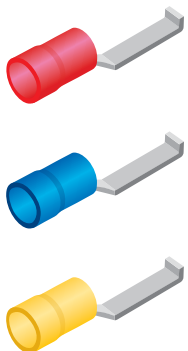
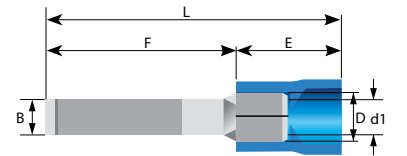

KOD	KABLO KESİTİ	ÖLÇÜLER (mm)						AD. / ʘ	KUTU ADEDİ
		B	F	L	E	D	d1		
ONKA-LB1-3A	0.5 ~ 1.5 mm 22 ~ 16 AWG	3.0	18.0	29.0	11.0	4.1	1.7	1,113	200
ONKA-LB1-4.6A		4.6							
ONKA-LB2-3A	1.5 ~ 2.5 mm 16 ~ 14 AWG	3.0	18.0	29.0	11.0	4.5	2.3	1,476	100
ONKA-LB2-4.6A		4.6							
ONKA-LB5-3A	4.0 ~ 6.0 mm 12 ~ 10 AWG	3.0	17.5	30.5	13.0	6.5	3.4	2,130	100
ONKA-LB5-4.6A		4.6							

FULL İZOLELİ ERKEK TERMİNAL & T BAĞLANTI TERMİNALİ

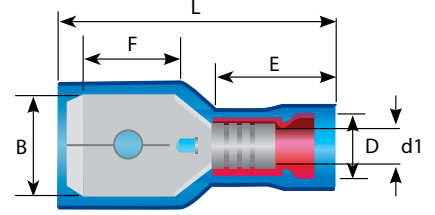
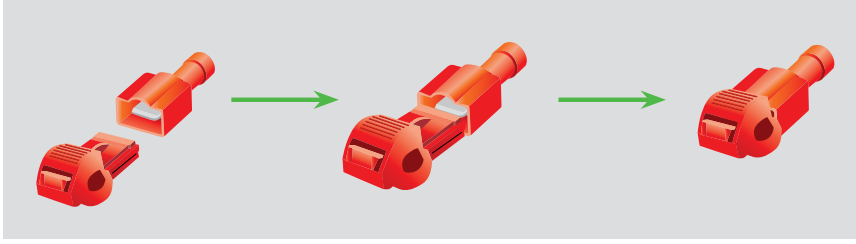

KOD	KABLO KESİTİ	ÖLÇÜLER (mm)						AD. / ʘ	KUTU ADEDİ
		B	F	L	E	D	d1		
ONKA-M1-6.4AFC	0.5 ~ 1.5 mm 22 ~ 16 AWG	6.35	7.9	23.5	10.5	4.2	1.7	0,945	100
ONKA-M2-6.4AFC	1.5 ~ 2.5 mm 16 ~ 14 AWG	6.35	7.9	23.5	10.5	4.9	2.3	1,071	100
ONKA-M5-6.4AFC	4.0 ~ 6.0 mm 12 ~ 10 AWG	6.35	7.9	27.0	13.0	6.5	3.4	1,512	100

Pirinç malzemeden kalay kaplı, Naylon izoleli, 105 °C çalışma sıcaklığı, 600 Volt enerjiye dayanabilme özelliğine sahiptir.

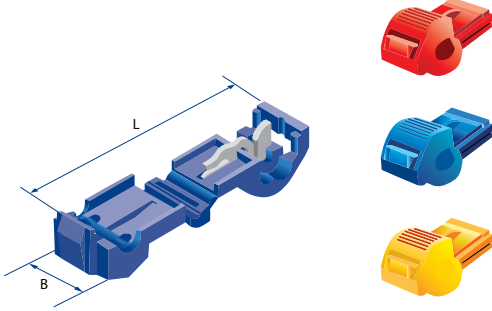

KOD	KABLO KESİTİ	ÖLÇÜLER (mm)		AD. / ʘ	KUTU ADEDİ
		B	L		
ONKA-SPM1A	0.5 ~ 1.5 mm 22 ~ 16 AWG	6.35	23.5	1,155	100
ONKA-SPM2A	1.5 ~ 2.5 mm 16 ~ 14 AWG	6.35	23.5	1,269	100
ONKA-SPM5A	4.0 ~ 6.0 mm 12 ~ 10 AWG	6.35	27.0	2,049	100

ÇENGEL İZOLELİ KABLO UCU

Pirinç Malzemeden Kalay Kaplı,
PVC İzoleli,
75 °C Çalışma Sıcaklığı,
300 Volt Enerjiye Dayanabilme.

EXTRA ÇİFT YÜKSÜKLÜ

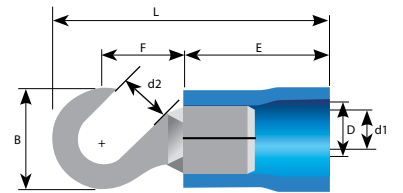

0,5 ~ 1,5 mm², Kablo Kesiti

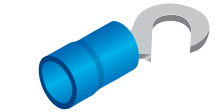

1,5 ~ 2,5 mm², Kablo Kesiti



4,0 ~ 6,0 mm², Kablo Kesiti

KOD	METRİK ÖLÇ. (d2)	B	L	F	E	D	d1	AD. / ʘ	K. AD.
ONKA - 8290-H1-4V	4.3	8.0	21.0	7.0	10.0	4.1	1.7	0,840	100
ONKA - 8291-H1-5V	5.3	8.0	21.0	7.0	10.0	4.1	1.7	0,894	100
ONKA - 8292-H1-6V	6.5	11.6	26.8	11.1	10.0	4.1	1.7	1,290	100
ONKA - 8293-H2-4V	4.3	8.5	22.0	7.8	10.0	4.5	2.3	1,155	100
ONKA - 8294-H2-5V	5.3	9.5	22.0	7.3	10.0	4.5	2.3	1,239	100
ONKA - 8295-H2-6V	6.5	12.0	27.0	11.0	10.0	4.5	2.3	1,416	100
ONKA - 8296-H5-4V	4.3	9.5	25.5	8.3	12.5	6.5	3.4	1,932	50
ONKA - 8297-H5-5V	5.3	9.5	25.0	8.3	12.5	6.5	3.4	1,953	50
ONKA - 8298-H5-6V	6.5	12.0	29.0	10.5	12.5	6.5	3.4	2,130	50

İZOLELİ KURŞUN ERKEK KABLO UCU



0,5 ~ 1,5 mm², Kablo Kesiti

KOD	B	F	L	E	D	d1	AD. / ʘ	K. AD.
ONKA-8200-BD1-4VD	4.0	8.5	21.0	10.0	4.3	1.7	0,882	100



1,5 ~ 2,5 mm², Kablo Kesiti

ONKA-8201-BD2-4VD	4.0	8.5	21.0	10.0	4.3	2.3	0,903	100
ONKA-8202-BD2-5VD	5.0	8.5	21.0	10.0	5.0	2.3	0,954	100

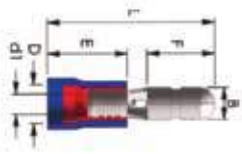

4,0 ~ 6,0 mm², Kablo Kesiti

ONKA-8203-BD5-5VD	5.0	8.5	23.5	13.0	6.5	3.4	1,416	100
--------------------------	-----	-----	------	------	-----	-----	--------------	-----

Bakır malzemeden, kalay kaplı, PVC izoleli, 75 °C çalışma sıcaklığı, 600 Volt enerjiye dayanabilme.

FULL İZOLELİ KURŞUN DIŞI KABLO UCU



0,5 ~ 1,5 mm², Kablo Kesiti

KOD	B	F	L	E	D	d1	AD. / ʘ	K. AD.
ONKA-8210-RE1-4VFD	4.0	9.0	23.5	11.0	4.3	1.7	0,891	100



1,5 ~ 2,5 mm², Kablo Kesiti

ONKA-8211-RE2-4VFD	4.0	9.0	23.5	11.0	5.0	2.3	0,915	100
ONKA-8212-RE2-5VFD	5.0	9.0	23.5	11.0	5.0	2.3	0,954	100

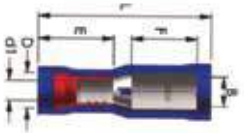

4,0 ~ 6,0 mm², Kablo Kesiti

ONKA-8213-RE5-5VFD	5.0	9.0	25.0	13.0	6.5	3.4	1,416	100
---------------------------	-----	-----	------	------	-----	-----	--------------	-----

Bakır malzemeden, kalay kaplı, PVC izoleli, 75 °C çalışma sıcaklığı, 300 Volt enerjiye dayanabilme.

İZOLELİ BAYRAK TİP KABLO UCU



Pirinç Malzemeden Kalay Kaplı,
PVC İzoleli,
105 °C Çalışma Sıcaklığı, 300
Volt Enerjiye Dayanabilme.

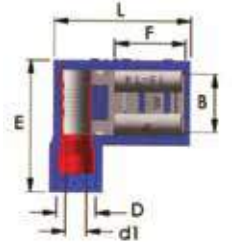

KOD	KABLO KESİTİ	RENK	SOKET GENİŞLİĞİ	B	L	F	E	D	d1	AD. / ʘ	K. AD.
ONKA-8225-FL1-6.4AC	0,5 - 1,5 mm ²	Kırmızı	0.8 x 6.4	6.6	7.9	16.1	15.0	4.5	1.7	1,071	100
ONKA-8226-FL2-6.4AC	1,5 - 2,5 mm ²	Mavi	0.8 x 6.4	6.6	7.9	16.1	15.0	4.5	1.7	1,071	100

HAWCON TERMINAL

HF-1D



HF-2D



HF-1D MİNİ



HF-1/2D



HF-3D



HF-1D EĞRİ



HF-1D MİNİ EĞRİ



HF-1DE



HF-1DE MİNİ



HF-1EÇK



HF-1EU1



HK-2,5-04



HK-4-04



HK-6-06



HW-4-04



HW-5-05



HKN1-04



HKN2,5-04



HKN4-05



HKN6-06



HKN6-08



HKN10-08



HKN10-10



HKN10-12



AVİZE TERMİNALİ





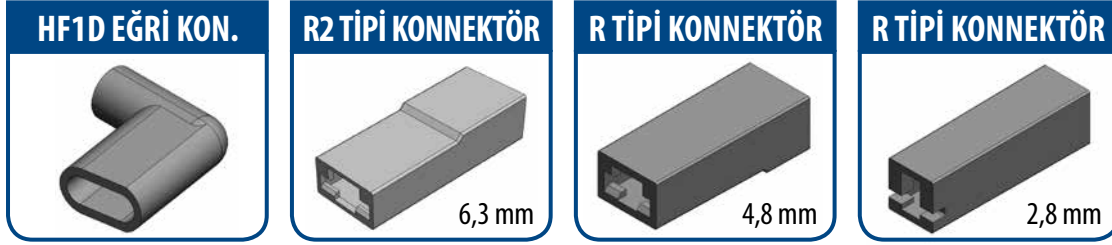

HAWCON – MESA İZOLESİZ KABLO UÇLARI ve KONNEKTÖRLER



ÜRÜN KODU	CİNSİ	TL / AD.
HF-1D	Dişi Terminal 6,3 mm	
HF-2D	Tırnaklı Diş Terminal 6,3 mm	
HF-1D	Mini Dişi Terminal 4,8 mm	
HF-½ D	Mikro Dişi Terminal 2,8 mm	

ÜRÜN KODU	CİNSİ	TL / AD.
HF-3D	Dişi Terminal	
HF-1D	Eğri Dişi Terminal 6,3 mm	
HF-1D	Mini Eğri Dişi Terminal 4,8 mm	
HF-1DE	Dişi + Erkek Terminal 6,3 mm	
HF-1D	DÇN Dişi Terminal 6,3 mm	
HF-2,5 D	Eğri Dişi Terminal 6,3 mm	

ÜRÜN KODU	CİNSİ	TL / AD.
HF-1E ÇK	Erkek Terminal 6,3 mm	
HF-1EU1	Uzun Erkek Terminal 6,3 mm	
HF-½	Mikro Erkek Terminal 2,8 mm	

ÜRÜN KODU	CİNSİ	TL / AD.
H HK-2,5	Boru Tip Top.Terminali	
H HK-4	Boru Tip Top.Terminali	
H HK-6	Boru Tip Top.Terminali	

ÜRÜN KODU	CİNSİ	TL / AD.
H HW-4	Topraklama Terminali	
HHKN1	Topraklama Terminali	
HHKN2,5	Topraklama Terminali	
HHKN4	Topraklama Terminali	
HHKN6	Topraklama Terminali	
HHKN10	Topraklama Terminali	
HSB-W	Buji Terminali	

ÜRÜN KODU	CİNSİ	TL / AD.
HHKN1 C	Çatal Terminal	
HHKN2,5 C	Çatal Terminal	
HHKN4 C	Çatal Terminal	
HHKN6 C	Çatal Terminal	

ÜRÜN KODU	CİNSİ	TL / AD.
H HF-1D DPK	(Kalaylı) 6,3 mm	
H HF-1D B	(Büyük ayak)	
H HF-23 D	Kilitli Zımbalı Dişi Fiş 6,3 mm	
HFK-1-04	Topraklama Terminali	

ÜRÜN KODU	CİNSİ	TL / AD.
KYD-3801 / KYE-3901	1'Lİ DİŞİ ve ERKEK KONNEKTÖR	
KYD-3802 / KYE-3902	2'Lİ DİŞİ ve ERKEK KONNEKTÖR	
KYD-3803 / KYE-3903	3'LÜ DİŞİ ve ERKEK KONNEKTÖR	
KYD-3804 / KYE-3904	4'LÜ DİŞİ ve ERKEK KONNEKTÖR	
KYD-3805 / KYE-3905	6'Lİ DİŞİ ve ERKEK KONNEKTÖR	
KYD-3806 / KYE-3906	9'LU DİŞİ ve ERKEK KONNEKTÖR	
KYD-3807 / KYE-3907	12'Lİ DİŞİ ve ERKEK KONNEKTÖR	
KYD-3808 / KYE-3908	15'Lİ DİŞİ ve ERKEK KONNEKTÖR	
TYE-2705 / HF-22 E	ERKEK TERMİNAL	
TYD-2614 / HF-22 D	DİŞİ TERMİNAL	

ÜRÜN KODU	CİNSİ	TL / AD.
HF-1D	Kılıf 6,3 mm	
HF-1D	Kılıf 6,3 mm Renkli	
HF-1D	Mini Kılıf 4,8 mm	
HF-1E	Erkek Kılıf 6,3 mm	
HF-3D	Kılıf 9,5 mm	
HF-1D	PVC Kılıf 6,3 mm	
HF-1D	PVS Eğri Kılıf (ithal)	

ÜRÜN KODU	CİNSİ	TL / AD.
R Tipi	Konnektör 6,3 mm	
R Tipi	Konnektör 4,8 mm	
R Tipi	Konnektör 2,8 mm	
HF-1D	Eğri Konnektör 6,3 mm	

ÜRÜN KODU	CİNSİ	TL / AD.
BYT - 10	Bakır Top.Kablo Ucu	
BYT - 16	Bakır Top.Kablo Ucu	
BYT - 25	Bakır Top.Kablo Ucu	
BYT - 35	Bakır Top.Kablo Ucu	
BYT - 50	Bakır Top.Kablo Ucu	
BYT - 70	Bakır Top.Kablo Ucu	

ÜRÜN KODU	CİNSİ	TL / AD.
41100	Telefon.Çatal Terminal	
Mikro	Telefon Dişi Fiş 2,8 mm	

ÜRÜN KODU	CİNSİ	TL / AD.
HHFK-25	Kart Tipi Erkek Terminal 6,3 mm	
HHFK-35	Kart Tipi Erkek Terminal 6,3 mm	
HHFK-39	Kart Tipi Erkek Terminal 6,3 mm	
HHFK-43	Kart Tipi Erkek Terminal 6,3 mm	
TÖZ-2031	Kart Tipi DPK Dişi Terminal 6,3 mm	
TD-2162	DPK Kart Tipi Dişi Terminal 6,3 mm	
Kart Tipi	Asker Terminal 2,8 mm	

ÜRÜN KODU	CİNSİ	TL / AD.
HF-1D DPG	Dişi Terminal 6,3 mm	
HF-2D DPG	(TD-2114.80) Gümüş Ter.	
HF-1D ½	DPG Mikro Dişi Fiş 2,8 mm	
HF-1EU1	DPG Uzun Erkek	
HF-1D	MINİ DÇN	

Onka®

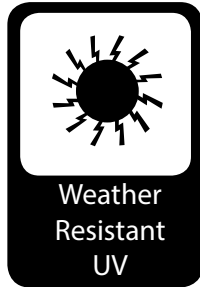

KABLO BAĞLARI

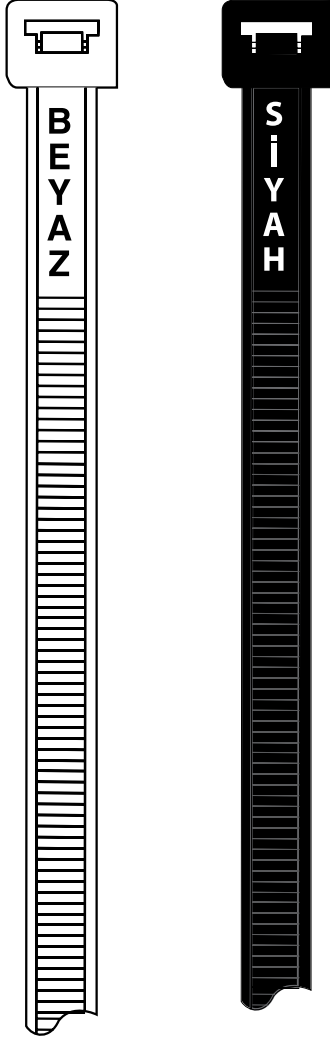
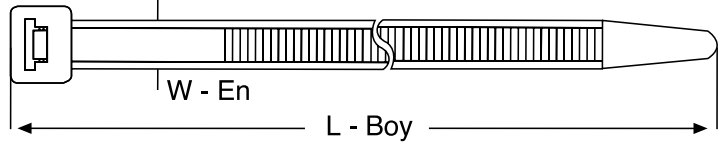

KOD	L	W	MAK. BAĞ. ÇAPI	TAŞI. AĞIR. (kg)	AD. / ʘ	POŞET ADEDİ	KOLİ ADEDİ
ONKA - 8480	100	2.5	22	8.1	0,042	100 / 1000	70.000
ONKA - 8432	140	2.5	40	8.1	0,062	100 / 1000	45.000 / 50.000
ONKA - 8482	200	2.5	53	8.1	0,092	100 / 1000	40.000 / 45.000
ONKA - 8483	150	3.6	35	18.2	0,095	100 / 1000	33.000
ONKA - 8484	200	3.6	53	18.2	0,126	100 / 1000	25.000
ONKA - 8485	250	3.6	65	18.2	0,165	100 / 1000	20.000
ONKA - 8486	300	3.6	76	18.2	0,203	100 / 1000	20.000
ONKA - 8487	370	3.6	102	18.2	0,246	100 / 1000	15.000
ONKA - 8489	200	4.8	50	22.2	0,179	100	16.000
ONKA - 8490	250	4.8	60	22.2	0,227	100	13.000
ONKA - 8491	300	4.8	76	22.2	0,270	100	13.000
ONKA - 8492	370	4.8	102	22.2	0,338	100	10.000
ONKA - 8493	430	4.8	110	22.2	0,429	100	9.000
ONKA - 8495	300	7.6	76	54.5	0,495	100	6.500
ONKA - 8496	370	7.6	102	54.5	0,570	100	5.000
ONKA - 8497	450	7.6	127	54.5	0,750	100	3.500
ONKA - 8498	530	7.6	140	54.5	0,930	100	3.000
ONKA - 8502	710	9.0	190	79.4	1,875	100	2.000

B

GW ürünleri DUPONT marka, nylon 6/6 hammaddeden imal edilmiş olup, – 40 + 85 °C ortam sıcaklığında çalışır. UL 94 / V2 normunda, kendini söndürme özelliğine sahiptir. Yüksek kaliteli

S

GW kablo bağları (benzin, mazot, hayvansal yağ, boya, vernik) gibi maddelere karşı üstün direnç göstermektedir. Ürünler beyaz / siyah ve yandaki renkler olarak STOK mevcuttur. Beyaz / siyah renk dışındaki kablo bağlarının fiyatları farklıdır. Diğer renk istekleriniz için firmamızla irtibata geçiniz. Ürünlerimizin dış ortam kullanımı için UV Modelleri mevcuttur.

KABLO BAĞLARI (Renkli)

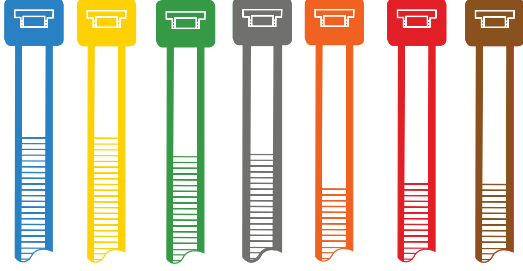

KOD	L	W	MAK. BAĞ. ÇAPI	TAŞI. AĞIR. (kg)	AD. / ₺	POŞET ADEDİ	KOLİ ADEDİ
ONKA - 8178	100	2.5	22	8.1	0,126	100 / 1000	70.000
ONKA - 8179	140	2.5	40	8.1	0,189	100 / 1000	45.000
ONKA - 8180	200	2.5	53	8.1	0,294	100 / 1000	40.000 / 45.000
ONKA - 8181	150	3.6	35	18.2	0,294	100 / 1000	35.000
ONKA - 8182	200	3.6	53	18.2	0,378	100 / 1000	25.000
ONKA - 8183	250	3.6	65	18.2	0,492	100 / 1000	20.000
ONKA - 8184	300	3.6	76	18.2	0,615	100 / 1000	20.000
ONKA - 8185	300	4.8	76	22.2	0,870	100	13.000
ONKA - 8205	370	4.8	102	22.2	1,092	100	10.000
ONKA - 8209	370	7.6	102	54.5	1,827	100	5.000
ONKA - 8218	450	7.6	127	54.5	2,100	100	3.000
ONKA - 8219	530	7.6	140	54.5	2,730	100	3.000

GW ürünleri DUPONT marka, nylon 6/6 hammaddeden imal edilmiş olup, - 40 - 85 °C ortam sıcaklığında çalışır. UL 94 / V2 normunda, kendini söndürme özelliğine sahiptir. Yüksek kaliteli GW kablo bağları (benzin, mazot, hayvansal yağ, boya, vernik) gibi maddelere karşı üstün direnç göstermektedir. Ürünler beyaz / siyah ve yandaki renkler olarak STOK mevcuttur. Beyaz / siyah renk dışındaki kablo bağlarının fiyatları farklıdır. Diğer renk istekleriniz için firmamızla irtibata geçiniz. Ürünlerimizin dış ortam kullanımı için UV modelleri mevcuttur.

ULTRAVIOLE KABLO BAĞLARI

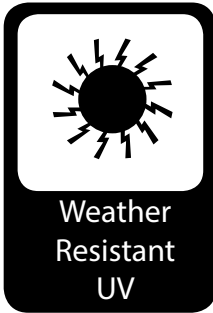
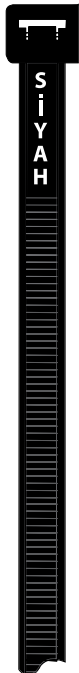

Sipariş Kodu	L	W	MAKS. BAĞ. ÇAPI	TAŞ. AĞIR. (Kg)	ADET (₺)	POŞET ADEDİ	KOLİ ADEDİ
ONKA - 8950	100	2.5	22	8.1	0,045	1000	70.000
ONKA - 8952	140	2.5	33	8.1	0,074	100	55.000
ONKA - 8956	200	2.5	53	8.1	0,098	100	45.000 / 50.000
ONKA - 8960	150	3.6	35	18.2	0,113	100	33.000
ONKA - 8962	200	3.6	53	18.2	0,150	100	25.000
ONKA - 8964	250	3.6	65	18.2	0,195	100	20.000
ONKA - 8966	300	3.6	76	18.2	0,240	100	20.000
ONKA - ?????	370	3.6	102	18.2	0,255	100	20.000
ONKA - 8970	200	4.8	50	22.2	0,210	100	16.000
ONKA - 8972	250	4.8	60	22.2	0,270	100	13.000
ONKA - 8974	300	4.8	76	22.2	0,323	100	13.000
ONKA - 8976	370	4.8	102	22.2	0,405	100	10.000
ONKA - 8980	300	7.6	76	54.5	0,585	100	6.500
ONKA - 8982	370	7.6	102	54.5	0,675	100	5.000
ONKA - 8984	450	7.6	127	54.5	0,885	100	3.500
ONKA - 8986	530	7.6	140	54.5	1,080	100	3.000
ONKA - 8990	760	9.0	236	79.4	2,250	100	2.000
ONKA - 8994	940	9.0	280	79.4	3,000	100	1.000

ÖZEL KABLO BAĞLARI



KULLANIM ALANLARI

Gıda ve ilaç endüstrilerinde kullanılan tipik metal dedektörleri, metal algılama sistemleri ve X-Ray kontrol sistemleri tarafından algılanma ve reddedilme yeteneğine sahiptir.

Özellikle gıda ve ilaç endüstrilerinde hammadde, yarımamül, diğer ürün yan girdi ambalajları, poşet, torba, çuval ağızlarının bağlanmasında, üretim hatlarındaki elektrik kablo, boru ve boru demetlerinin bağlanmasında ve diğer tesisatların sabitlenmesinde, ürünü kirletme riski bulunan makine aksamlarının sabitlenmesinde vb... ve diğer bir çok uygulama alanında kullanılmak üzere tasarlanmıştır. Kuvvetli ve dayanıklı malzemelerden Naylon 6, Naylon 6.6, Polypropilen malzemelerden yapılmıştır.

Ürün boyunca dağıtılmış metal içeriğe sahiptir ve bu sebeple parçalar halinde kesilseler dahi tespit edilebilme özelliğine sahiptir.

Genel Özellikler :

- Metal algılama sistemleri (metal dedektörü ve mıknatıs) tarafından tespit edilebilir,
- X-Ray kontrol sistemleri tarafından tespit edilebilir,
- HACCP sisteminin bir parçası olarak kullanılabilir,
- Farklı renk seçenekleri mevcuttur (sadece DTMN 0500 ürünü için geçerli),
- Uygun maliyetlidir,
- Çevre dostudur.



METAL DEDEKTÖRLERİ

X-RAY KONTROL SİSTEMLERİ

ENDÜSTRİYEL MİKNATISLAR

KİLİTLİ KABLO BAĞI

KOD	RENK	BOY (mm)	EN (mm)	AD. / ʘ	POŞET/AD.
DTMN 01523	MAVİ	92	2,4	ʘ	100
DTMN 01525		186	4,8		100
DTMN 01527		340	7		100
DTMN 01528		360	4,8		100

KABLO BAĞI

KOD	RENK	BOY (mm)	EN (mm)	AD. / ʘ	POŞET/AD.
DTMN 01529	MAVİ	150	3,5	ʘ	100
DTMN 01530		200	4,6		100
DTMN 01531		145	3,4		100
DTMN 01532		185	4,6		100
DTMN 01533		380	4,7		100
DTMN 01540		390	7,6		100

RENKLİ KABLO BAĞI

KOD	RENK	BOY (mm)	EN (mm)	AD. / ʘ	POŞET/AD.
DTMN 0500	MAVİ	390	4,6	ʘ	100
	KIRMIZI				100
	SARI				100
	YEŞİL				100
	TURUNCU				100

TEKRAR KULLANILABİLİR KABLO BAĞI

KOD	RENK	BOY (mm)	EN (mm)	AD. / ʘ	POŞET/AD.
DTMN 01539	MAVİ	250	4,7	ʘ	100



PASLANMAZ SINIFI 304 ÇELİK KABLO BAĞLARI

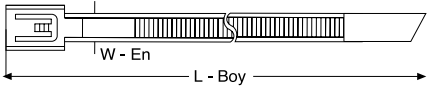

AISI 304 Paslanmaz Çelik

KOD	L	W	MAK. BAĞ. ÇAPI	TAŞI. AĞIR. (kg)	AD. / TL 304 PASLANMAZ	POŞET ADEDİ	KOLİ ADEDİ
ONKA - 8600	127	4.6	25.0	46	1,869	100	8000
ONKA - 8601	152	4.6	37.0	46	1,890	100	8000
ONKA - 8602	201	4.6	50.0	46	2,100	100	6000
ONKA - 8603	266	4.6	69.0	46	2,310	100	6000
ONKA - 8604	300	4.6	76.0	46	2,520	100	4000
ONKA - 8605	362	4.6	102	46	2,835	100	4000
ONKA - 8606	521	4.6	152	46	3,330	100	3000
ONKA - 8607	679	4.6	203	46	4,620	100	2000
ONKA - 8608	838	4.6	254	46	5,460	100	2000
ONKA - 8609	152	7.9	25.0	114	2,940	100	4000
ONKA - 8610	201	7.9	50.0	114	3,150	100	3000
ONKA - 8611	266	7.9	69.0	114	3,570	100	3000
ONKA - 8612	300	7.9	76.0	114	3,675	100	2000
ONKA - 8613	362	7.9	102	114	3,780	100	2000
ONKA - 8614	521	7.9	152	114	4,830	100	1500
ONKA - 8615	679	7.9	203	114	5,775	100	1000
ONKA - 8616	838	7.9	254	114	7,140	100	1000

PASLANMAZ SINIFI 316 ÇELİK KABLO BAĞLARI

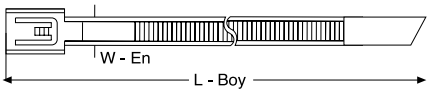
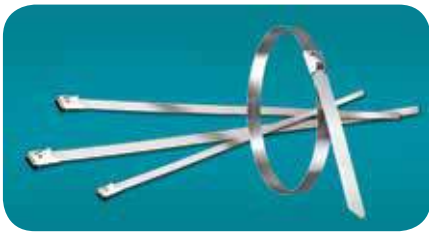

AISI 316 Paslanmaz Çelik

KOD	L	W	MAK. BAĞ. ÇAPI	TAŞI. AĞIR. (kg)	AD. / 316 PASLANMAZ	POŞET ADEDİ	KOLİ ADEDİ
ONKA - 8600	127	4.6	25.0	46	2,802	100	8000
ONKA - 8601	152	4.6	37.0	46	2,835	100	8000
ONKA - 8602	201	4.6	50.0	46	3,150	100	6000
ONKA - 8603	266	4.6	69.0	46	3,465	100	6000
ONKA - 8604	300	4.6	76.0	46	3,780	100	4000
ONKA - 8605	362	4.6	102	46	4,200	100	4000
ONKA - 8606	521	4.6	152	46	4,980	100	3000
ONKA - 8607	679	4.6	203	46	6,930	100	2000
ONKA - 8608	838	4.6	254	46	8,190	100	2000
ONKA - 8609	152	7.9	25.0	114	4,410	100	4000
ONKA - 8610	201	7.9	50.0	114	4,725	100	3000
ONKA - 8611	266	7.9	69.0	114	5,355	100	3000
ONKA - 8612	300	7.9	76.0	114	5,460	100	2000
ONKA - 8613	362	7.9	102	114	5,670	100	2000
ONKA - 8614	521	7.9	152	114	7,245	100	1500
ONKA - 8615	679	7.9	203	114	8,610	100	1000
ONKA - 8616	838	7.9	254	114	10,710	100	1000

PANELE KAFADAN SIKIŞAN KABLO BAĞI

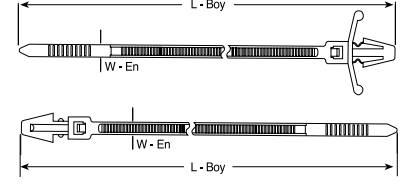

KOD	L	W	MAKSİMUM BAĞLAMA ÇAPI	TAŞIMA AĞIRLIĞI (kg)	DELİK ÇAPI (Ø)	AD. / ʘ	POŞET ADEDİ
ONKA - 8380	100	2.5	22	12	Ø 4.8	0,273	100
ONKA - 8382	200	4.8	46	25	Ø 6.4	0,579	100

ETİKETLİ KABLO BAĞI

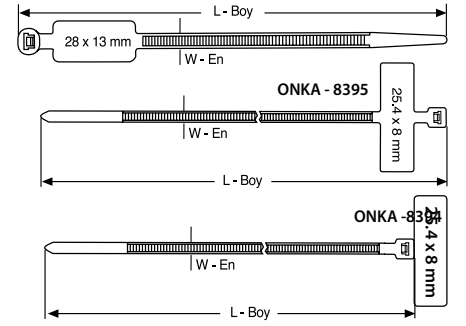
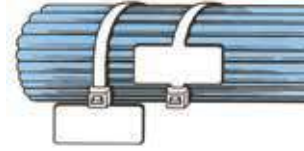
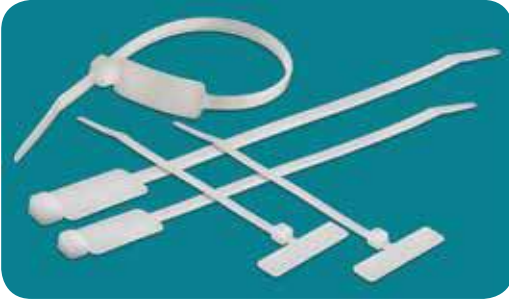

KOD	L	W	MAKSİMUM BAĞLAMA ÇAPI	TAŞIMA AĞIRLIĞI (kg)	AD. / ʘ	POŞET ADEDİ
ONKA - 8390	100	2.5	18	8.1	0,315	100
ONKA - 8395	100	2.5	18	8.1	0,315	100
ONKA - 8396	195	4.8	45	22.2	0,681	100

KAFADAN VİDA MONTAJLI KABLO BAĞI

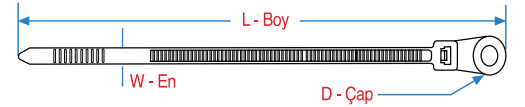

KOD	L	W	D	MAKSİMUM BAĞLAMA ÇAPI	TAŞIMA AĞIRLIĞI (kg)	AD. / ʘ	POŞET ADEDİ
ONKA - 8411	200	v4.8	4.8	54	22.2	0,525	1000

BONCUK TİP KABLO BAĞI



KOD	L	W	MAKSİMUM BAĞLAMA ÇAPI	TAŞIMA AĞIRLIĞI (kg)	AD. / ʘ	POŞET ADEDİ
GTB-110 M	105	2	25	5	0,210	1.000
GTB-150 I	165	3.5	45	7	0,441	500

ÖRNEK UYGULAMALAR

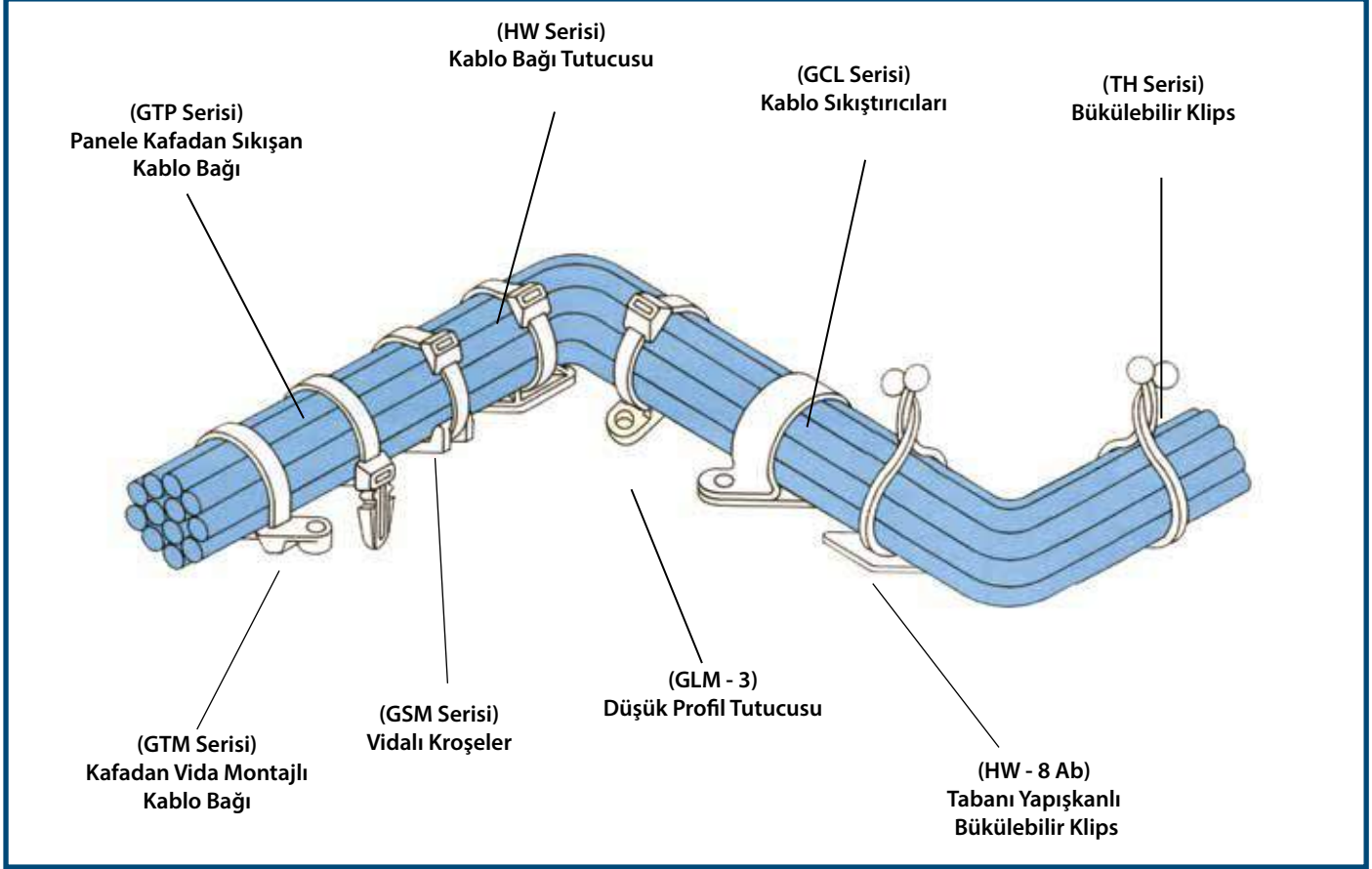

DUBELLİ KABLO TUTUCULAR (Delik Çapı : Ø 4.8 mm)

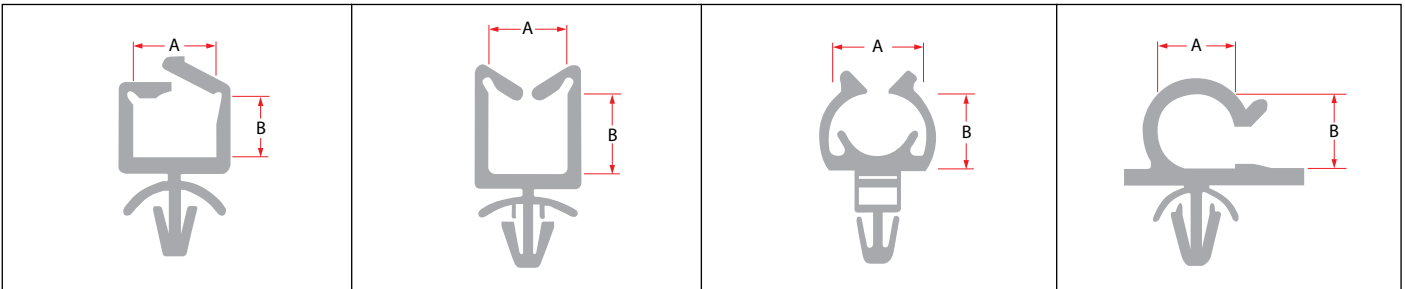
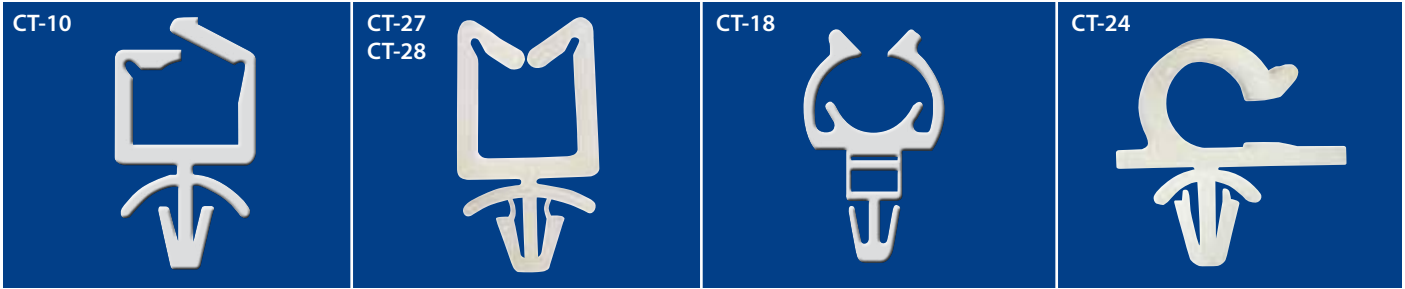

KOD	YÜKSEKLİK	GENİŞLİK	A	B	AD./ (t)	POŞET ADEDİ
ONKA-CT-10	21.7 mm	15.3 mm	11.3 mm	6.0 mm	0,483	1000
ONKA-CT-27	27.3 mm	15.2 mm	11.2 mm	9.8 mm	0,546	
ONKA-CT-28	36.3 mm	15.2 mm	11.2 mm	19.0 mm	0,630	
ONKA-CT-18	22.0 mm	15.5 mm	11.6 mm	7.0 mm	0,483	
ONKA-CT-24	20.3 mm	20.0 mm	8.0 mm	8.0 mm	0,924	

TABAN YAPIŞKANLI BÜKÜLEBİLİR KLİPS

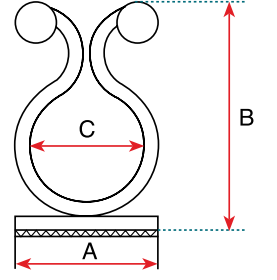

KOD	A	B	C	AD. / ʘ	POŞET ADEDİ
ONKA - 8435	20 x 20	32	16	2,625	100

BÜKÜLEBİLİR KLİPS

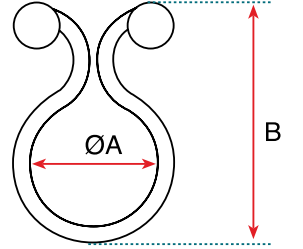
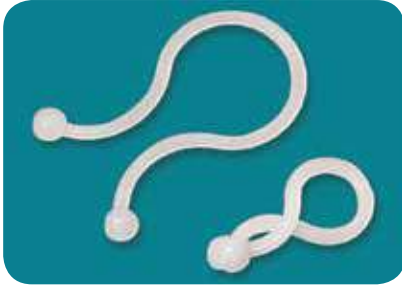

ÜRÜN CİNSİ	TH-D	TH-E	TH-F	TH-G	TH-H	TH-I	TH-J	TH-K	TH-L
KOD	ONKA-8370	ONKA-8371	ONKA-8372	ONKA-8373	ONKA-8374	ONKA-8375	ONKA-8376	ONKA-8377	ONKA-8378
ØA	11.2	5.2	8.3	11.5	15.0	18.0	19.5	22.5	5.2
B	28.4	21.0	25.2	30.9	35.1	40.0	42.5	45.5	22.0
BAĞLAMA ÇAPI	10.2	4.5	7.3	10.5	14.0	17.0	19.0	22.0	5.0
POŞET ADEDİ	1000	1000	1000	1000	1000	1000	1000	1000	1000
AD. / ʘ	0,399	0,390	0,306	0,378	0,399	0,483	0,840	0,945	0,399

FLAT CABLE KABLO TUTUCUSU

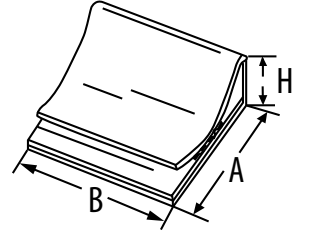

KOD	A	B	H	AD. / ʘ	K. AD.
ONKA - 8433	15	26	6.5	1,575	100
ONKA - 8434	25	26	10.0	2,100	100

TABANI YAPIŞKANLI KANCALI KLİPS

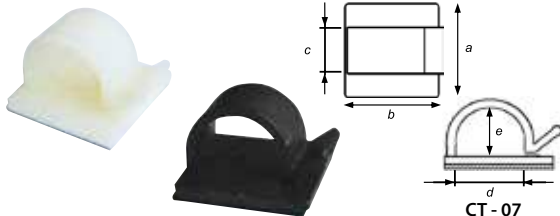

KOD	A	B	C	D	MAX. BAĞLAMA GENİŞLİĞİ (E)	AD. / ʘ	K. AD.
CT-05	25	25	12.7	12.5	8	1,050	100
CT-07	25	25	12.7	16.5	12	1,260	100

VİDALI KROŞELER

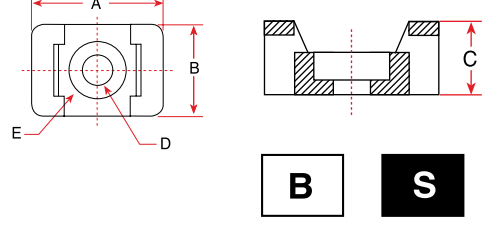

KOD	A	B	C	D	E	MAK. BAĞ. GENİŞLİĞİ	AD. / ʘ	KUTU ADEDİ	
ONKA - 8360	2	14.9	9.5	6.9	4.5	7.8	4.8	0,306	100
ONKA - 8361	3	22.2	15.9	9.7	6.4	12.6	7.6	0,378	100
ONKA - 8595	5	30.0	15.0	11.7	4.8	-	7.6	0,525	100

DÜŞÜK PROFİL TUTUCUSU

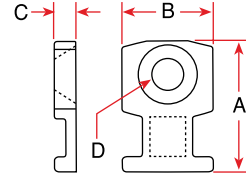

KOD	A	B	C	D	MAK. BAĞ. GENİŞLİĞİ	AD. / ʘ	KUTU ADEDİ
ONKA - 8445	19.1	12.7	3.4	4.5	4.8	1,575	100

KABLO SIKIŞTIRICILARI

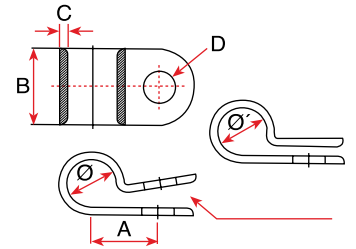

KOD	Ø	Ø'	A	B	C	D	AD. / ʘ	POŞET ADEDİ
ONKA - 8450 1/8S	3.6	3.3	8.2	9.1	1.27	M5	0,360	100
ONKA - 8451 3/16S	5.3	4.8	9.6	9.1	1.27	M5	0,600	100
ONKA - 8452 1/4S	7.4	6.6	10.3	9.1	1.27	M5	0,42	100
ONKA - 8453 5/16S	8.9	7.8	10.6	9.1	1.27	M5	0,462	100
ONKA - 8454 3/8S	10.9	9.7	11.9	9.2	1.27	M5	0,546	100
ONKA - 8457 3/8	9.5	9.1	13.4	12.7	1.50	M5	0,756	100
ONKA - 8458 1/2	12.7	12.2	15.0	12.7	1.50	M5	1,260	100
ONKA - 8459 9/16	14.2	13.8	15.8	12.7	1.50	M5	1,995	100
ONKA - 8460 3/4	19.0	18.6	19.8	12.7	1.50	M5	2,310	100
ONKA - 8461 7/8	22.2	21.8	21.4	12.7	1.50	M5	3,640	100

BETON KROŞE

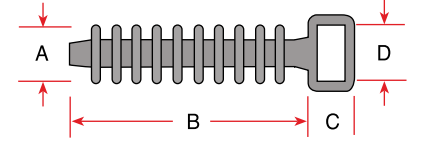

KOD	A	B	C	D	MAK. BAĞ. GENİŞLİĞİ	AD. / ʘ	KUTU ADEDİ
ONKA - 8362	9.5	36.0	6.0	9.5	9.5	0,378	100

BASKILI DEVRE TAŞIYICILARI

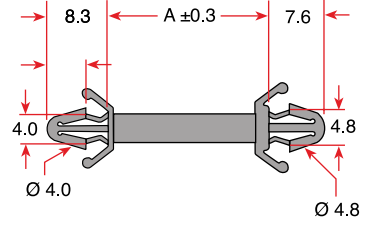

KOD	ÖLÇÜ (A)	AD. / ʘ	KUTU ADEDİ
ONKA - 8420 CBS-6A	6.2	0,305	1000
ONKA - 8421 CBS-9A	9.2	0,441	1000
ONKA - 8422 CBS-13A	12.6	0,483	1000
ONKA - 8423 CBS-16A	15.8	0,840	1000
ONKA - 8424 CBS-19A	19.1	1,680	1000

TERS KİLİTLEMELİ BASKILI DEVRE TAŞIYICILARI

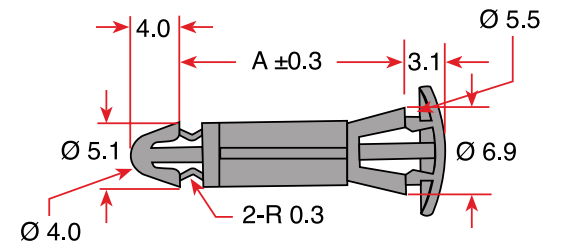

KOD	ÖLÇÜ (A)	AD. / ʘ	KUTU ADEDİ
ONKA - 8425 WMB-5	5.0	0,546	1000
ONKA - 8427 WMB-8	8.0	0,588	1000
ONKA - 8428 WMB-10	10.0	0,672	1000
ONKA - 8429 WMB-12	12.0	0,756	1000
ONKA - 8430 WMB-14	14.0	0,84	1000
ONKA - 8431 WMB-19	19.0	1,26	1000

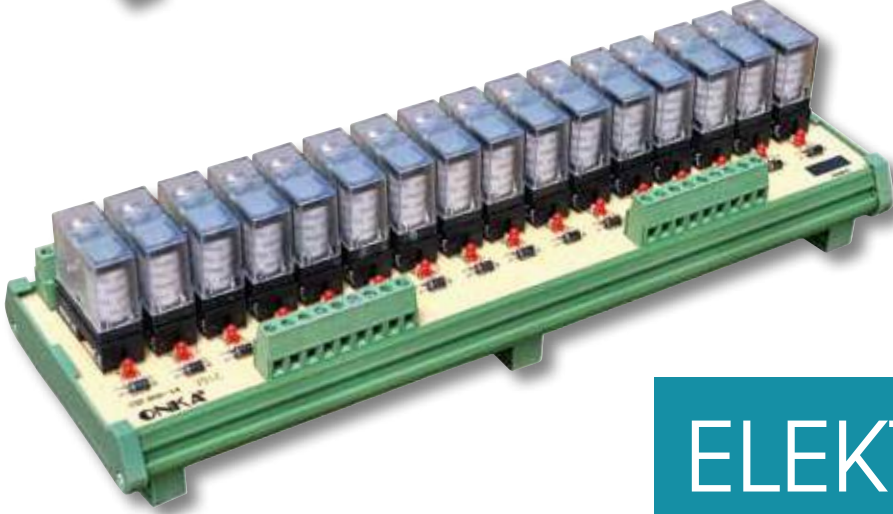
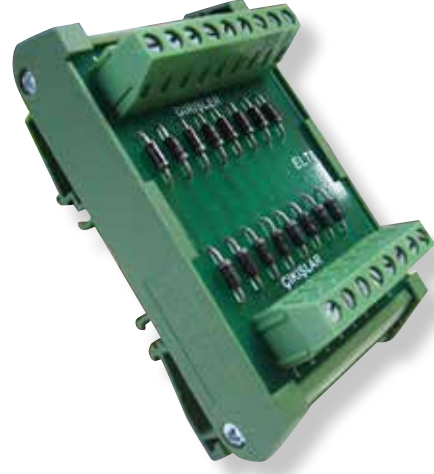

ELEKTRONİK KLEMENSLER

Röle ve Diyot
Modüller



PUSH IN

ELEKTRONİK DEVRELİ KLEMENSLER



KOD	AÇIKLAMA	AD. / ʈ
ONKA-600-ERDM	Ters Akım Koruma Modülü	38,32
ONKA-601-ERDM	Bobin Ters Akım Koruma Modülü	36,95
ONKA-602-ERDM	Lamba Test Modülü Tekli	38,32
ONKA-603-ERDM	İki Kanallı Diyot Modül	38,32
ONKA-604-ERDM	Gerilim Göstergesi 24 VDC	39,90
ONKA-605-ERDM	Gerilim Göstergesi 220 VAC	45,38
ONKA-606-ERDM	Gerilim Göstergesi Ters Akım Boşaltmalı 24 VDC	41,28
ONKA-607-ERDM	Aşırı Gerilim Koruma 30 V	48,34
ONKA-608-ERDM	Aşırı Gerilim Koruma 75 V	50,60
ONKA-609-ERDM	Aşırı Gerilim Koruma 130 V	50,60
ONKA-610-ERDM	Aşırı Gerilim Koruma 275 V	50,60
ONKA-611-ERDM	Gerilim Göstergesi - Doğrultma 24 VAC	45,38
ONKA-612-ERDM	Gerilim Göstergesi - Doğrultma 110 VAC	45,38
ONKA-613-ERDM	Gerilim Göstergesi - Doğrultma 220 VAC	45,38

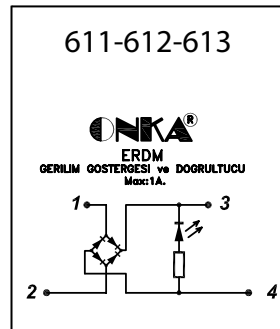
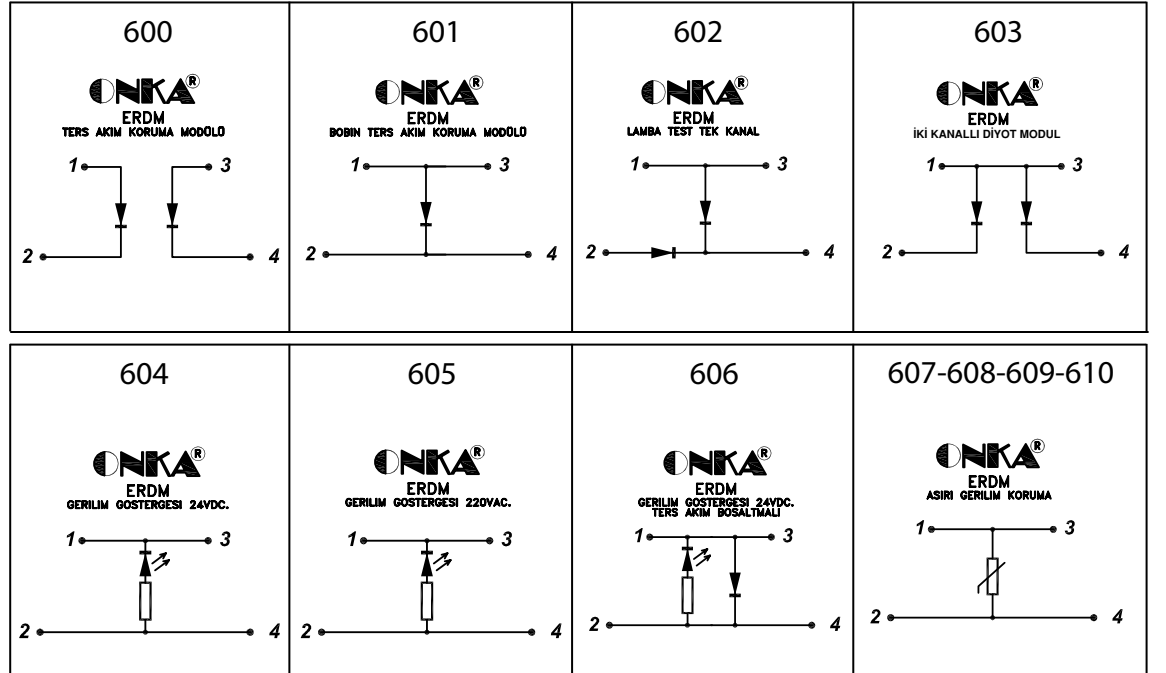

600 Ters Akım Koruma



Özelliği: DC Gerilimlerde bobin devrelerinde akımın ters gelmesini engeller. Herhangi bir kontaktör, röle, valf eğer DC akımda kullanılıyor ise bu bobin devrelerinin elektriklerini kestiğimiz anda 1000 V civarına ulaşabilecek ters EMK voltaj oluşabilmektedir. Bu zıt EMK 'da bobinden önceki devreye oldukça zarar verebilir. Bu olay DC akımda kullanılan bobinler için geçerlidir.

Bobin Ters Akım Koruma

601



602 Lamba Test Kartları



Özelliği: Sinyal devrelerinde lambaların sağlam olup olmadığını kontrol eder. Elektrik panolarında kullanılan sinyal lambaları veya büyük tesislerde kullanılan mimik diyagramlardaki led aydınlatmalar bizlere herhangi bir sistemin çalıştığını veya arızası olduğunu bildirirler. Ancak ampullerinin patlaması veya led'in bozulması durumunda tesisteki büyük bir arıza durumunu göremeyebiliriz. O yüzden bu lambaların belli aralıklarla sağlamlığının test edilmesi gerekmektedir. Lamba test olarak kullanılan kartlar bu test işlemini bir buton üzerinden sistemi bozmadan yapmamıza olanak tanır.

İki Kanallı Diyot Modül

603

604 - 605 Gerilim Göstergeleri



Özelliği: Yapılan elektrik sistemlerindeki voltaj VAR/YOK durumunu izler. Üzerinde bulunan LED ışık sayesinde bağlı bulunduğu elektrik sistemindeki gerilimin var olup olmadığını gösterir.

606 Ters Akım Korumalı Gerilim Göstergeleri



Özelliği: Bağlandığı yerdeki 24 VDC gerilimi led vasıtası ile var/yok olarak gösterir. Aynı zamanda içerisindeki diyot ile bobini ters akımdan korur.

607 608 Aşırı Gerilim Koruma 30 VAC-75 VAC- 609 130 VAC-275 VAC 610



Özelliği : Varistör üzerindeki gerilime duyarlı olan bir dirençtir. Üzerindeki gerilimle ters orantılı olarak direnci değişir. Bu yüzden korunacak olan devre veya elemana paralel olarak bağlanır. Gerilim 30 V geçtiği zaman devreyi kısa devre ederek ona bağlı olan sigortanın atmasını sağlar.

611 612 Gerilim Göstergesi ve Doğrultma 613 Devresi 24-110-220 VAC



Özelliği: 1 ve 2 numaralı klemenslerden uygulanan AC (Alternatif akım) diyotların köprü bağlantısı ile DC (Doğru Akım) şekline dönerek 3-4 klemenslerinden kullanıcıya verilir. Bu dönüşümün yapılabildiği LED göstergesi ile anlaşılır. Bir amperlik köprü diyottur.

ELEKTRONİK KLEMENSLER

101 ... 107

Diyot Kartları



Özelliği : 7 farklı tipte imal edilmektedirler. 6'lı, 12'li, 14'lü ortak anot, 14'lü ortak katot, 22'li ortak anot ve 22'li ortak katot şeklindedir. Diyot ihtiyaç olan yerlerde klemens bağlantısı olmasından dolayı tercih edilir. Diyotlar 1 A ve 700 V olarak kullanılmaktadır..

120 - 121

Lamba Test Kartları



Özelliği : Makina veya elektrik panosundaki sinyal lambalarını kontrol eder. 8 kanallı ve 16 kanallı diye 2 tip imal edilmektedir.

130 ... 132

Optokupler Modülleri



Özelliği: PLC veya micro işlemcili sistemlerde güç devresi ile elektronik devreyi elektriksel olarak birbirlerinden izole ederek PLC veya mikro işlemcinin bozulmasını engeller. Bu kartımız PLC veya mikro işlemciye giriş/çıkış olarak kullanılır. 4 kanalıdır. Genellikle giriş sinyallerinin güçlendirilmesi ve izole edilmesi için tercih edilir. Kartımızın girişi 5 V DC -12 - 24 V DC çıkışı ise 24 V DC, NPN'dir (Yani "-" çıkış). Her iki devrede izole halindedir. Üzerindeki LED ile çalışması takip edilebilir.

255 405

Röle Modülleri

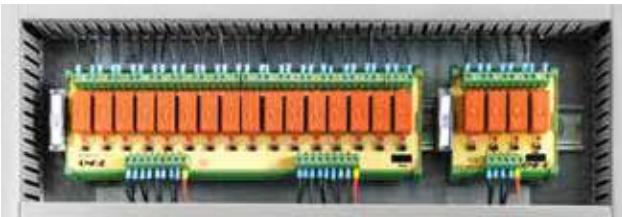

Özelliği : Röle, neredeyse kumanda panolarının olmazsa olmazıdır. Her elektrik panosunu açtığınızda % 95 ihtimalle görebileceğiniz bir malzemedir. Bizim imalatlarımızda, bu röleleri standart olarak LED'li, ters akım koruma diyotlu olarak imal edilmekte ve tek tek kullanılan rölelerden daha cazip hale gelmektedir. Aynı zamanda röle sayısı azaldığından daha ekonomiktir. İmalatda 2 kanallı, 4 kanallı, 8 kanallı ve 16 kanallı olarak yapılmaktadır. Gerilim olarak 24 V DC ve 220 V AC dir. Bu modellerimiz soketli olarak yapılmaktadır.



LAMBA TEST MODÜLLERİ

KOD	AÇIKLAMA	AD. / ₺
ONKA-120-ELT8	Lamba Test Kartı 8 Kanallı	175,55
ONKA-122-ELT11	Lamba Test Kartı 11 Kanallı	180,78
ONKA-121-ELT16	Lamba Test Kartı 16 Kanallı	230,23



DİYOT KARTLARI

KOD	AÇIKLAMA	AD. / ₺
ONKA-101-EDM6	Diyot Kartı 6 Kanallı	150,00
ONKA-102-EDM8	Diyot Kartı 8 Kanallı	170,00
ONKA-103-EDM12	Diyot Kartı 12 Kanallı	197,00
ONKA-104-EDM14A	Diyot Kartı 14 Kanallı Ortak Anot	190,00
ONKA-105-EDM14K	Diyot Kartı 14 Kanallı Ortak Katot	179,00
ONKA-106-EDM22A	Diyot Kartı 22 Kanallı Ortak Anot	220,00
ONKA-107-EDM22K	Diyot Kartı 22 Kanallı Ortak Katot	220,00



OPTOKUPLER MODÜLÜ

KOD	AÇIKLAMA	AD. / ₺
ONKA-130-EOM-4	Optokupler Kartı 4 Kanallı 5 VDC Giriş, 24 VDC Çıkış, NPN	364,15
ONKA-131-EOM-4	Optokupler Kartı 4 Kanallı 12 VAC / DC Giriş, 24 VDC Çıkış, NPN	364,15
ONKA-132-EOM-4	Optokupler Kartı 4 Kanallı 24 VAC / DC Giriş, 24 VDC Çıkış, NPN	364,15



RÖLE KARTLARI

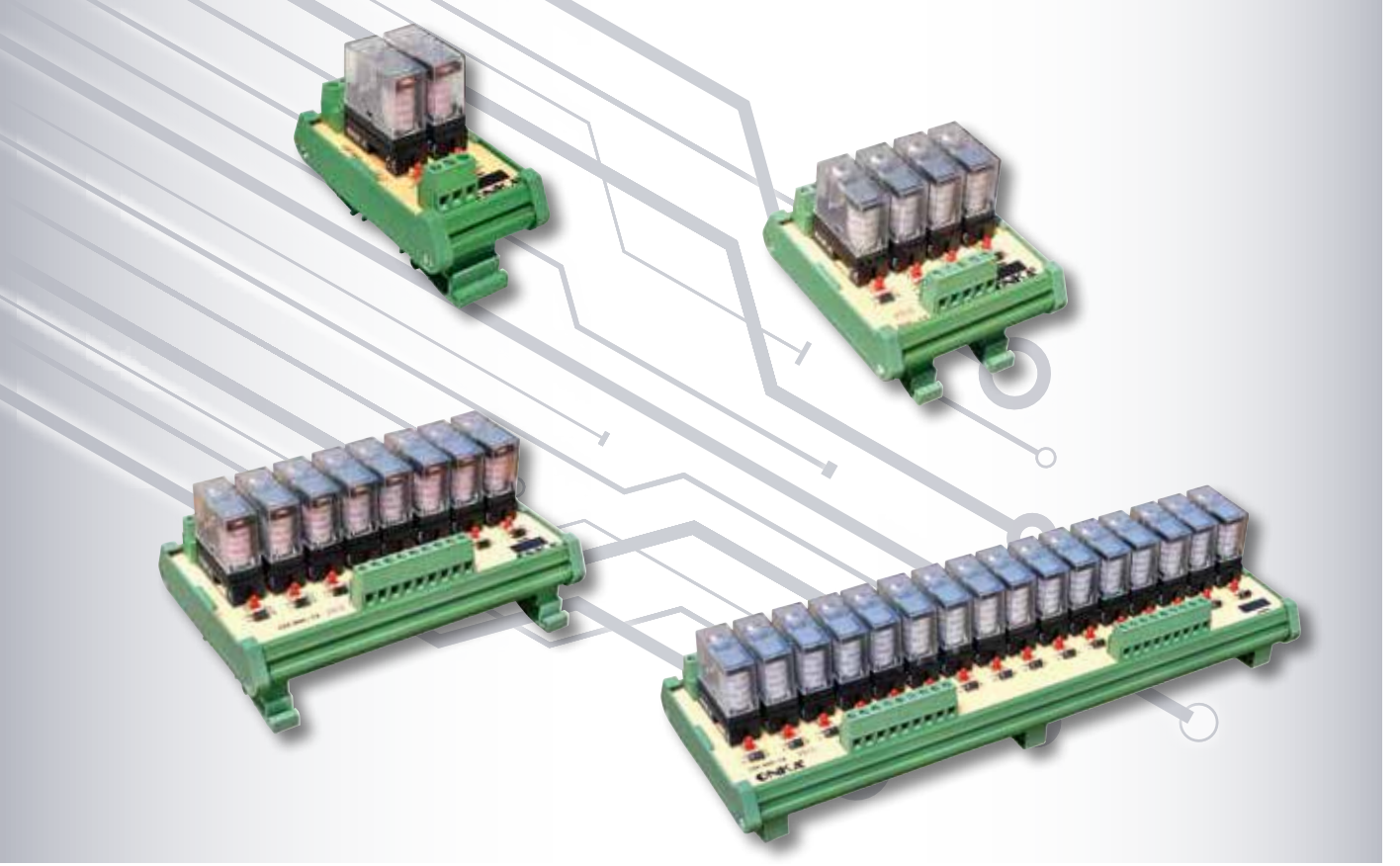

TEK KONTAK İKİLİ

KOD	AÇIKLAMA	AD. / ₺
ONKA-255-E24RMTS2 (+)	Tek Kontak 16 A. Röle Modülü Soketli "+ Ortak" 24 VDC.	314,40
ONKA-257-E24RMTS2 (-)	Tek Kontak 16 A. Röle Modülü Soketli "- Ortak" 24 VDC.	314,40
ONKA-265-E220RMTSO2	Tek Kontak 16 A. Röle Modülü Soketli 220 VAC.	434,63

TEK KONTAK DÖRTLÜ

KOD	AÇIKLAMA	AD. / ₺
ONKA-305-E24RMTS4 (+)	Tek Kontak 16 A. Röle Modülü Soketli "+ Ortak" 24 VDC.	536,56
ONKA-307-E24RMTS4 (-)	Tek Kontak 16 A. Röle Modülü Soketli "- Ortak" 24 VDC.	536,56
ONKA-315-E220RMTSO4	Tek Kontak 16 A. Röle Modülü Soketli 220 VAC.	627,52

TEK KONTAK SEKİZLİ

KOD	AÇIKLAMA	AD. / ₺
ONKA-355-E24RMTS8 (+)	Tek Kontak 16 A. Röle Modülü Soketli "+ Ortak" 24 VDC.	945,40
ONKA-357-E24RMTS8 (-)	Tek Kontak 16 A. Röle Modülü Soketli "- Ortak" 24 VDC.	945,40
ONKA-365-E220RMTSO8	Tek Kontak 16 A. Röle Modülü Soketli 220 VAC.	1.123,36

TEK KONTAK ONALTILI

KOD	AÇIKLAMA	AD. / ₺
ONKA-401-E24RMTS16 (+)	Tek Kontak 16 A. Röle Modülü Soketli "+ Ortak" 24 VDC.	1.795,50
ONKA-403-E24RMTS16 (-)	Tek Kontak 16 A. Röle Modülü Soketli "- Ortak" 24 VDC.	1.795,50
ONKA-405-E220RMTSO16	Tek Kontak 16 A. Röle Modülü Soketli 220 VAC.	2.146,00

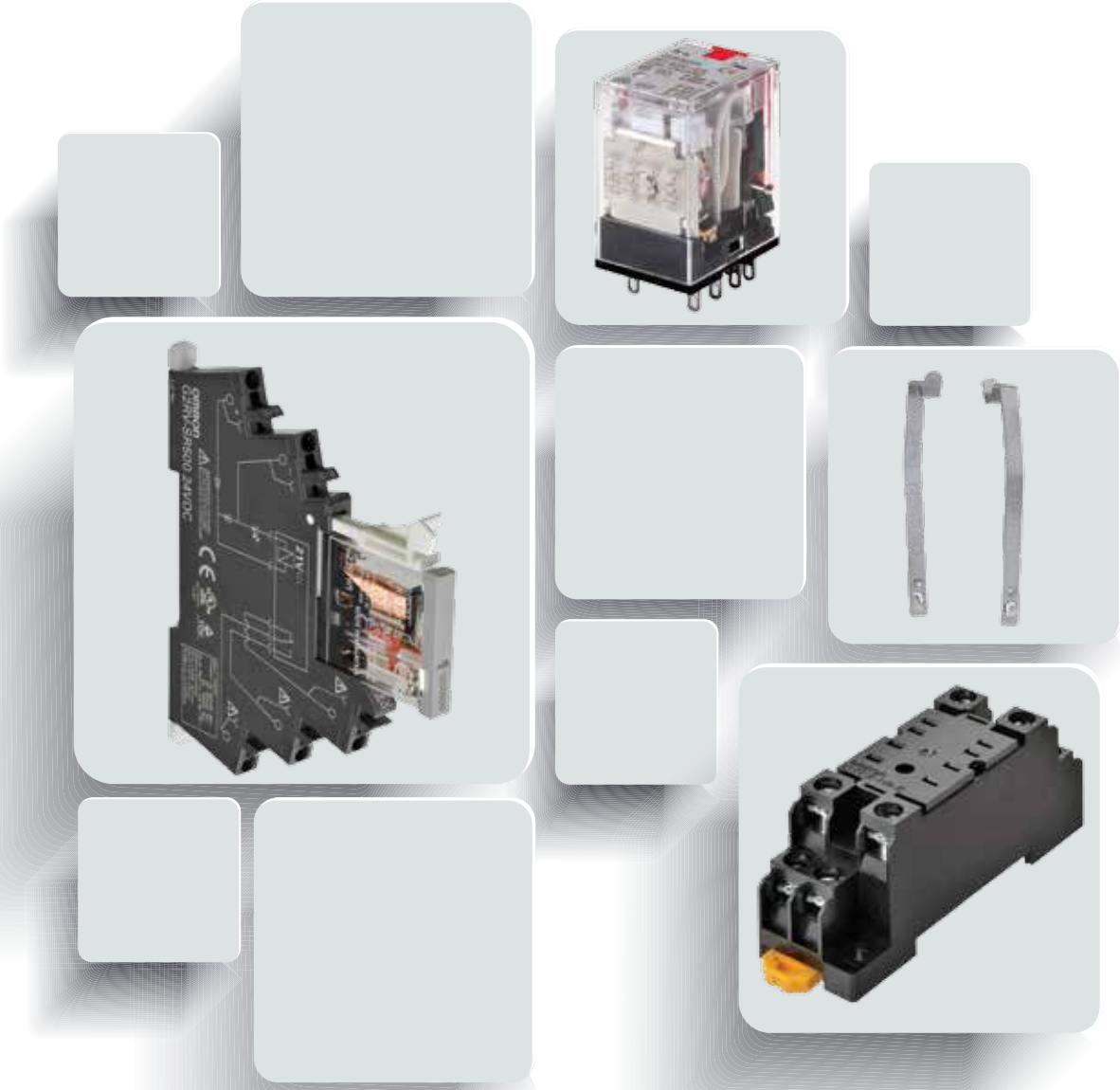

ONKA SLIM RÖLE + SOKET 6A

KOD	çinsi	AD. / €	K. AD.
G2RV-SR500 24VDC	24 V DC VİDA BASKILI SLIM RÖLE + SOKET	⌚	10
G2RV-SR500 24VAC/DC	24 V AC VİDA BASKILI SLIM RÖLE + SOKET	⌚	10
G2RV-SR500 230VAC	220 V AC VİDA BASKILI SLIM RÖLE + SOKET	⌚	10
G2RV	KÖPRÜLEME BARASI	⌚	10

MİNYATÜR RÖLE - 2 KONTAKLI



KOD	CİNSİ	AD. / €	K. AD.
MY2IN-GS 24VDC	24 V DC MİNYATÜR RÖLE 2NO / 2NC	10	10
MY2IN-GS 24VAC	24 V AC MİNYATÜR RÖLE 2NO / 2NC	10	10
MY2IN-GS 220/240VAC	220 V AC MİNYATÜR RÖLE 2NO / 2NC	10	10
PYFZ-08-E	2 KONTAK MİNYATÜR RÖLE SOKETİ	50	50

MİNYATÜR RÖLE - 4 KONTAKLI



KOD	CİNSİ	AD. / €	K. AD.
MY4IN-GS 24VDC	24 V DC MİNYATÜR RÖLE 4NO / 4NC	10	10
MY4IN-GS 24VAC	24 V AC MİNYATÜR RÖLE 4NO / 4NC	10	10
MY4IN-GS 220/240VAC	220 V AC MİNYATÜR RÖLE 4NO / 4NC	10	10
PYFZ-14-E	4 KONTAK MİNYATÜR RÖLE SOKETİ	50	50

MİNYATÜR RÖLE AKSESUARLAR



KOD	CİNSİ	AD. / €	K. AD.
PYC-A1	AÇMA KLİPSİ	1 SET	1 SET

MİNYATÜR RÖLE

1 Kontak 5 Pin Minyatür Röle (Faston Tipi Bacaklı) 12A



KOD	AD. / \$	K. AD.
SLOK-JQX-14FT-1C-12VDC	3,80 \$	50
SLOK-JQX-14FT-1C-24VDC	3,80 \$	50
SLOK-JQX-14FT-1C-48VDC	4,32 \$	50
SLOK-JQX-14FT-1C-24VAC	6,08 \$	50
SLOK-JQX-14FT-1C-230VAC	6,40 \$	50
AKSESUAR		
SLOK-SRU05-E	3,48 \$	10
SLOK-SR25C	0,20 \$	10
SABİTLEME TELİ	Ⓢ	10

2 Kontak 8 Pin Minyatür Röle (Yassı Bacaklı) 8A



KOD	AD. / \$	K. AD.
SLOK-JQX-14FT-2C-12VDC	4,00 \$	50
SLOK-JQX-14FT-2C-24VDC	4,00 \$	50
SLOK-JQX-14FT-2C-48VDC	4,60 \$	50
SLOK-JQX-14FT-2C-24VAC	6,40 \$	50
SLOK-JQX-14FT-2C-230VAC	6,68 \$	50
AKSESUAR		
SLOK-SRU08-E	3,68 \$	10
SLOK-SR25C	0,20 \$	10
SABİTLEME TELİ	Ⓢ	10

1 Kontak 8 Pin Minyatür Röle (İğne Bacaklı) 12A



KOD	AD. / \$	K. AD.
SLOK-JQX-14FC-1CH-12VDC	3,24 \$	50
SLOK-JQX-14FC-1CH-24VDC	3,24 \$	50
SLOK-JQX-14FC-1CH-48VDC	3,80 \$	50
SLOK-JQX-14FC-1CH-24VAC	8,32 \$	50
SLOK-JQX-14FC-1CH-230VAC	6,52 \$	50
AKSESUAR		
SLOK-SRC08-E	3,48 \$	10
SLOK-SR25C	0,20 \$	10
SABİTLEME TELİ	Ⓢ	10

2 Kontak 8 Pin Minyatür Röle (İğne Bacaklı) 8A



KOD	AD. / \$	K. AD.
SLOK-JQX-14FC-2C-12VDC	3,16 \$	50
SLOK-JQX-14FC-2C-24VDC	3,16 \$	50
SLOK-JQX-14FC-2C-48VDC	3,88 \$	50
SLOK-JQX-14FC-2C-24VAC	7,72 \$	50
SLOK-JQX-14FC-2C-230VAC	6,68 \$	50
AKSESUAR		
SLOK-SRC08-E	3,48 \$	10
SLOK-SR25C	0,20 \$	10
SABİTLEME TELİ	Ⓢ	10

1 Kontak 5 Pin Minyatür Röle (Faston Tipi Bacaklı) 12A



KOD	AD. / \$	K. AD.
SLOK-RFT1CO012VDC	4,28 \$	50
SLOK-RFT1CO024VDC	3,64 \$	50
SLOK-RFT1CO048VDC	4,28 \$	50
SLOK-RFT1CO110VDC	4,28 \$	50
SLOK-RFT1CO524VAC	5,48 \$	50
SLOK-RFT1CO730VAC	4,48 \$	50
AKSESUAR		
SLOK-SRU05-E	3,16 \$	10
SLOK-SR20T	0,20 \$	10
SABİTLEME TELİ	Ⓢ	10

2 Kontak 8 Pin Minyatür Röle (Yassı Bacaklı) 8A



KOD	AD. / \$	K. AD.
SLOK-RFT2CO012VDC	4,64 \$	50
SLOK-RFT2CO024VDC	3,96 \$	50
SLOK-RFT2CO048VDC	4,64 \$	50
SLOK-RFT2CO110VDC	4,64 \$	50
SLOK-RFT2CO524VAC	5,84 \$	50
SLOK-RFT2CO730VAC	4,80 \$	50
AKSESUAR		
SLOK-SRU08-E	3,16 \$	10
SLOK-SR20T	0,20 \$	10
SABİTLEME TELİ	Ⓢ	10

LEDLİ ve TEST BUTONLU

1 Kontak 5 Pin Minyatür Röle (Faston Tipi Bacaklı) 12A



KOD	AD. / \$	K. AD.
SLOK-RFT1CO012LTVDC	6,32 \$	50
SLOK-RFT1CO024LTVDC	5,56 \$	50
SLOK-RFT1CO048LTVDC	6,32 \$	50
SLOK-RFT1CO110LTVDC	6,32 \$	50
SLOK-RFT1CO524LTVAC	8,56 \$	50
SLOK-RFT1CO730LTVAC	6,24 \$	50
AKSESUAR		
SLOK-SRU05-E	3,16 \$	10
SLOK-SR20T	0,20 \$	10
SABİTLEME TELİ	Ⓢ	10

LEDLİ ve TEST BUTONLU

2 Kontak 8 Pin Minyatür Röle (Yassı Bacaklı) 8A



KOD	AD. / \$	K. AD.
SLOK-RFT2CO012LTVDC	6,68 \$	50
SLOK-RFT2CO024LTVDC	5,88 \$	50
SLOK-RFT2CO048LTVDC	6,68 \$	50
SLOK-RFT2CO110LTVDC	6,68 \$	50
SLOK-RFT2CO524LTVAC	8,64 \$	50
SLOK-RFT2CO730LTVAC	6,80 \$	50
AKSESUAR		
SLOK-SRU08-E	3,16 \$	10
SLOK-SR20T	0,20 \$	10
SABİTLEME TELİ	Ⓢ	10

2 KONTAK 8 PİN ENDÜSTRİYEL TİP RÖLE 7A



KOD	AD. / \$	K. AD.
SLOK-JQX-13F-KF2CL-12VDC	5,40 \$	20
SLOK-JQX-13F-KF2CL-24VDC	5,40 \$	20
SLOK-JQX-13F-KF2CL-48VDC	6,20 \$	20
SLOK-JQX-13F-KF2CL-110VDC	6,20 \$	20
SLOK-JQX-13F-KF2CL-24VAC	6,24 \$	20
SLOK-JQX-13F-KF2CL-230VAC	5,92 \$	20
AKSESUAR		
SLOK-SKB08-E	3,16 \$	10
SLOK-SK36F	0,24 \$	5
SLOK-SK36M	0,24 \$	10

4 KONTAK 14 PİN ENDÜSTRİYEL TİP RÖLE 5A



KOD	AD. / \$	K. AD.
SLOK-JQX-13F-KF4CL-12VDC	5,28 \$	20
SLOK-JQX-13F-KF4CL-24VDC	5,40 \$	20
SLOK-JQX-13F-KF4CL-48VDC	6,20 \$	20
SLOK-JQX-13F-KF4CL-110VDC	6,20 \$	20
SLOK-JQX-13F-KF4CL-24VAC	6,20 \$	20
SLOK-JQX-13F-KF4CL-230VAC	5,92 \$	20
AKSESUAR		
SLOK-SKB14-E	4,44 \$	10
SLOK-SK36F	0,24 \$	5
SLOK-SK36M	0,24 \$	10

2 KONTAK 8 PİN ENDÜSTRİYEL TİP RÖLE 7A



KOD	AD. / \$	K. AD.
SLOK-RKE2CO012LTVDC	4,84 \$	20
SLOK-RKE2CO024LTVDC	4,40 \$	20
SLOK-RKE2CO048LTVDC	4,84 \$	20
SLOK-RKE2CO110LTVDC	4,84 \$	20
SLOK-RKE2CO524LTVAC	4,84 \$	20
SLOK-RKE2CO730LTVAC	4,84 \$	20
AKSESUAR		
SLOK-SKB08-E	3,84 \$	10
SLOK-SK36F	0,24 \$	5
SLOK-SK36M	0,24 \$	10

4 KONTAK 14 PİN ENDÜSTRİYEL TİP RÖLE 5A



KOD	AD. / \$	K. AD.
SLOK-RKE4CO012LTVDC	4,84 \$	20
SLOK-RKE4CO024LTVDC	4,40 \$	20
SLOK-RKE4CO048LTVDC	4,84 \$	20
SLOK-RKE4CO110LTVDC	4,84 \$	20
SLOK-RKE4CO524LTVAC	4,84 \$	20
SLOK-RKE4CO730LTVAC	4,84 \$	20
AKSESUAR		
SLOK-SKB14-E	4,44 \$	10
SLOK-SK36F	0,24 \$	5
SLOK-SK36M	0,24 \$	10

YENİ

2 KONTAK 8 PİN ENDÜSTRİYEL TİP RÖLE 12A



KOD	AD. / \$	K. AD.
SLOK-RKF2CO012LTVDC	7,40 \$	20
SLOK-RKF2CO024LTVDC	6,36 \$	20
SLOK-RKF2CO048LTVDC	7,40 \$	20
SLOK-RKF2CO110LTVDC	7,40 \$	20
SLOK-RKF2CO524LTVAC	8,16 \$	20
SLOK-RKF2CO730LTVAC	7,12 \$	20
AKSESUAR		
SLOK-SKB08-E	3,68 \$	10
SLOK-SK36F	0,24 \$	5
SLOK-SK36M	0,24 \$	10

4 KONTAK 14 PİN ENDÜSTRİYEL TİP RÖLE 6A



KOD	AD. / \$	K. AD.
SLOK-RKF4CO012LTVDC	7,96 \$	20
SLOK-RKF4CO024LTVDC	6,88 \$	20
SLOK-RKF4CO048LTVDC	7,96 \$	20
SLOK-RKF4CO110LTVDC	7,96 \$	20
SLOK-RKF4CO524LTVAC	8,68 \$	20
SLOK-RKF4CO730LTVAC	7,64 \$	20
AKSESUAR		
SLOK-SKB14-E	4,44 \$	10
SLOK-SK36F	0,24 \$	5
SLOK-SK36M	0,24 \$	10

2 KONTAK 8 PİN ENDÜSTRİYEL TİP RÖLE 16A



KOD	AD. / \$	K. AD.
SLOK-REH2CO012LTVDC	18,68 \$	20
SLOK-REH2CO024LTVDC	17,60 \$	20
SLOK-REH2CO048LTVDC	18,68 \$	20
SLOK-REH2CO110LTVDC	18,68 \$	20
SLOK-REH2CO524LTVAC	20,76 \$	20
SLOK-REH2CO730LTVAC	19,72 \$	20
AKSESUAR		
SLOK-SEB11-E	5,68 \$	10
SLOK-SE52M	0,44 \$	10

3 KONTAK 11 PİN ENDÜSTRİYEL TİP RÖLE 16A



KOD	AD. / \$	K. AD.
SLOK-REH3CO012LTVDC	19,72 \$	20
SLOK-REH3CO024LTVDC	18,68 \$	20
SLOK-REH3CO048LTVDC	18,68 \$	20
SLOK-REH3CO110LTVDC	19,72 \$	20
SLOK-REH3CO524LTVAC	21,04 \$	20
SLOK-REH3CO730LTVAC	20,00 \$	20
AKSESUAR		
SLOK-SEB11-E	5,68 \$	10
SLOK-SE52M	0,44 \$	10

2 KONTAK 8 PİN (YUVARLAK PİN) END. TİP RÖLE 10A



KOD	AD. / \$	K. AD.
SLOK-MK2PLT-12VDC	8,52 \$	20
SLOK-MK2PLT-24VDC	8,24 \$	20
SLOK-MK2PLT-48VDC	8,24 \$	20
SLOK-MK2PLT-110VDC	8,52 \$	20
SLOK-MK2PLT-24VAC	8,52 \$	20
SLOK-MK2PLT-230VAC	7,96 \$	20
AKSESUAR		
SLOK-SUB08-E	3,56 \$	10
SLOK-SU52M	0,60 \$	10

3 KONTAK 11 PİN (YUVARLAK PİN) END. TİP RÖLE 7A



KOD	AD. / \$	K. AD.
SLOK-MK3PLT-12VDC	8,92 \$	20
SLOK-MK3PLT-24VDC	8,92 \$	20
SLOK-MK3PLT-48VDC	8,92 \$	20
SLOK-MK3PLT-110VDC	8,92 \$	20
SLOK-MK3PLT-24VAC	8,92 \$	20
SLOK-MK3PLT-230VAC	8,12 \$	20
AKSESUAR		
SLOK-SUB11-E	4,12 \$	10
SLOK-SU52M	0,60 \$	10

2 KONTAK 8 PİN (YUVARLAK PİN) END. TİP RÖLE 10A



KOD	AD. / \$	K. AD.
SLOK-RUB2C1012LTVDC	10,32 \$	20
SLOK-RUB2C1024LTVDC	9,48 \$	20
SLOK-RUB2C1048LTVDC	10,32 \$	20
SLOK-RUB2C1110LTVDC	10,32 \$	20
SLOK-RUB2C1524LTVAC	10,68 \$	20
SLOK-RUB2C1730LTVAC	9,84 \$	20
AKSESUAR		
SLOK-SUB08-E	3,56 \$	10
SLOK-SU52M	0,60 \$	10

3 KONTAK 11 PİN (YUVARLAK PİN) END. TİP RÖLE 7A



KOD	AD. / \$	K. AD.
SLOK-RUB3C5012LTVDC	11,36 \$	20
SLOK-RUB3C5024LTVDC	8,80 \$	20
SLOK-RUB3C5048LTVDC	11,36 \$	20
SLOK-RUB3C5110LTVDC	11,36 \$	20
SLOK-RUB3C5524LTVAC	12,16 \$	20
SLOK-RUB3C5730LTVAC	8,80 \$	20
AKSESUAR		
SLOK-SUB11-E	3,56 \$	10
SLOK-SU52M	0,60 \$	10

VİDALI TİP, RAYA MONTAJ, 2 KONTAKLI GÜÇ RÖL. 25A



KOD	AD. / \$	K. AD.
SLOK-RGF2BD012LVDC	16,84 \$	20
SLOK-RGF2BD024LVDC	16,84 \$	20
SLOK-RGF2BD048LVDC	16,84 \$	20
SLOK-RGF2BD110LVDC	16,84 \$	20
SLOK-RGF2BD524LVAC	17,88 \$	20
SLOK-RGF2BD730LVAC	17,88 \$	20

FASTON BACAĞI, DÜZ ZEM. MON., 2 KON.GÜÇ RÖL. 25A



KOD	AD. / \$	K. AD.
SLOK-RGF2OU012VDC	15,76 \$	20
SLOK-RGF2OU024VDC	15,76 \$	20
SLOK-RGF2OU048VDC	15,76 \$	20
SLOK-RGF2OU110VDC	15,76 \$	20
SLOK-RGF2OU524VAC	16,84 \$	20
SLOK-RGF2OU730VAC	16,84 \$	20

VİDALI TİP, DÜZ ZEM. MON., 2 KONTAKLI GÜÇ RÖL. 25A



KOD	AD. / \$	K. AD.
SLOK-RGF2BU012LVDC	15,76 \$	20
SLOK-RGF2BU024LVDC	15,76 \$	20
SLOK-RGF2BU048LVDC	15,76 \$	20
SLOK-RGF2BU110LVDC	15,76 \$	20
SLOK-RGF2BU524LVAC	16,84 \$	20
SLOK-RGF2BU730LVAC	16,84 \$	20

GENEL AKSESUARLAR



KOD	ÇİNSİ	AD. / \$	K. AD.
SLOK-SKC14-S	14 PIN YASSI BACAĞI ENDÜSTRİYEL TİP RÖLE İÇİN SOKET PUSH-IN SİSTEM, YAY BASKILI BAĞLANTI	5,80 \$	10
SLOK-SKC11-E	11 PIN YASSI BACAĞI ENDÜSTRİYEL TİP RÖLE İÇİN SOKET	4,64 \$	10
SLOK-SRC08-P	5 mm PIN ARALIĞI, PCB KARTA MONTAJ 8 PIN İĞNE BACAĞI SOKET	1,24 \$	20
SLOK-SRC05-P	3.5 mm PIN ARALIĞI, PCB KARTA MONTAJ 5 PIN İĞNE BACAĞI SOKET	1,32 \$	20
SLOK-SNC05	SLİM RÖLE İÇİN PCB KARTA MONTAJ SOKET	6,24 \$	20
SLOK-SRB08-E	KISA TİP 5mm PIN ARALIĞI, İĞNE BACAĞI RÖLE İÇİN SOKET	3,84 \$	20
SLOK-AMD-L1	6/24V AC/DC LED MODÜL (YEŞİL LEDLİ)	1,56 \$	10
SLOK-AMD-L1	110/230V AC/DC LED MODÜL (YEŞİL LEDLİ)	1,56 \$	10
SLOK-AMD-LDD1-6-24VDC	24V DC LED MODÜL (YEŞİL LEDLİ)	2,60 \$	10



REAKTİF GÜÇ KONTROL RÖLELERİ



KOD	AÇIKLAMA	AD. / ₺	K. AD.
KAEL-VARKOMBI-18-PC-TFT-OG	Orta Gerilim Kompanzasyon Uygulamaları İçin	1.870,00	
KAEL-VARKOMBI-18-PC-TFT-OG-SOLAR	Orta Gerilim GES Kompanzasyon Uygulamaları İçin	2.100,00	
KAEL-VARKOMBI-18-PC-TFT	18 Kademe (Trifaze Kontrol) RS-485 Modbus - RTU Bilgisayar Haberleşme	1.650,00	
KAEL-VARKOMBI-18-TFT	18 Kademe (Trifaze Kontrol)	1.550,00	
KAEL-VARKOMBI-15-PC-TFT	15 Kademe Trifaze Kontrol RS-485 Modbus - RTU Bilgisayar Haberleşme	1.440,00	
KAEL-VARKOMBI-15-TFT	15 Kademe Trifaze Kontrol	1.250,00	
KAEL-VARKOMBI-12-PC-TFT	12 Kademe (Trifaze Kontrol) RS-485 Modbus - RTU Bilgisayar Haberleşme	1.290,00	
KAEL-VARKOMBI-12-TFT	12 Kademe (Trifaze Kontrol)	1.150,00	
KAEL-VARKO-15-TFT	15 Kademe (Trifaze Kontrol)	1.100,00	
KAEL-VARKO-12-TFT	12 Kademe (Trifaze Kontrol)	850,00	
KAEL-VARKOMBI-12-PC	12 Kademe (Trifaze Kontrol) RS-485 Modbus - RTU Bilgisayar Haberleşme	950,00	
KAEL-VARKOMBI-12	12 Kademe (Trifaze Kontrol)	850,00	
KAEL-VARKO-312	12 Kademe (Trifaze Kontrol)	830,00	
KAEL-VARKO-308	8 Kademe (Trifaze Kontrol)	810,00	
KAEL-VARKO-112	12 Kademe 1 Faz 1 Akım Trafosundan Kumanda alma, Kademe sayısı Seçimi (max 12)	800,00	
KAEL-VARKO-108	8 Kademe 1 Faz 1 Akım Trafosundan Kumanda	750,00	
KAEL-VARKO-106	6 Kademe 1 Faz 1 Akım Trafosundan Kumanda	600,00	
KAEL-PFR-3	Dalgıç Pomp. Pan. Kompanzasyonları İçin 3 Kademe	295,00	
KAEL-PFR-2	Dalgıç Pomp. Pan. Kompanzasyonları İçin 2 Kademe	280,00	
KAEL-PFR-1	Dalgıç Pomp. Pan. Kompanzasyonları İçin 1 Kademe	249,00	
KH100-CL0.5 100/5A	OG Akım Trafosu	1.130,00	1

DÖNÜŞTÜRÜCÜLER



KOD	AÇIKLAMA	AD. / ₺	K. AD.
KAEL-CON1	RS 485-USB Dönüştürücü	461,00	1
KAEL-CON2	RS 485 - Ethernet Dönüştürücü	510,00	1
KAEL-CON3	USB - Infrared Veri Aktarıcı	233,00	1
KAEL-CON5	RS 485 - Ethernet Dönüştürücü	710,00	1

ENERJİ ANALİZÖRLERİ



KOD	AÇIKLAMA	AD. / ₺	K. AD.
KAEL-MULTISER-05-PC-TFT	Şebeke Analizörü 3 Faz Ölçüm V, A Cos ϕ , Hz, W, VA, Σ W, Σ VA, Σ VAR 96 x 96 Renkli Ekran	1.650,00	6
KAEL-MULTISER-53-PC-TFT		1.260,00	6
KAEL-MULTISER-52-PC-TFT		1.450,00	6
KAEL-MULTISER-04-PC-TFT		1.600,00	6
KAEL-MULTISER-03-PC-TFT		1.550,00	6
KAEL-MULTISER-02-PC-TFT		1.530,00	6
KAEL-MULTISER-21-PC-TFT		1.390,00	6
KAEL-MULTISER-13-PC-TFT		1.047,00	6
KAEL-MULTISER-11-PC-TFT		950,00	6
KAEL-MULTISER-01-PC-TFT		1.250,00	6
KAEL-MULTISER-01-TFT		900,00	6
KAEL-MULTISER-TFT		800,00	6
KAEL-MULTISER-H1-TFT		1.300,00	6
KAEL-MULTISER-03-T-PC-TFT		1.590,00	6
KAEL-MULTISER-01-96	Şebeke Analizörü 3 Faz Ölçüm V, A Cos ϕ , Hz, W, VA, Σ W, Σ VA, Σ VAR DIN	415,00	12
KAEL-MULTISER-11-96		425,00	12
KAEL-MULTISER-01-PC-96		455,00	12
KAEL-MULTISER-11-PC-96		580,00	12
KAEL-MULTISER-02-PC-96		550,00	12
KAEL-MULTISER-03-PC-96	585,00	12	
KAEL-MICRO SD CARD	8 GB	150,00	1

ULTRA HIZLI GÜÇ DENGELİYİCİLER (SÜPER-SVC, SÜPER-TCR)



KOD	AÇIKLAMA	AD. / ₺	K. AD.
KAEL-SUPER-SVC	Ultra Hızlı, Çift Yönlü Reaktif Güç Dengeleyici	2.862,00	1
KAEL-SUPER-TCR-5	Ultra Hızlı, İndüktif Güç Dengeleyici	1.690,00	1
KAEL-SUPER-TCR-10	Ultra Hızlı, İndüktif Güç Dengeleyici (Gövdeye Montajlı Soğutma Fanı)	1.784,00	1
KAEL-SUPER-TCR-20	Ultra Hızlı, İndüktif Güç Dengeleyici	1.950,00	1
KAEL-SUPER-TCR-30	Ultra Hızlı, İndüktif Güç Dengeleyici (Gövdeye Montajlı Soğutma Fanı)	2.267,00	1
KAEL-SF	Soğutma Fanı	286,00	1

ENERJİ ANALİZÖRLERİ (EKONOMİK SERİ)



KOD	AÇIKLAMA	AD. / ₺	K. AD.
KAEL-MULTISER-01-DIN	Şebeke Analizörü 3 Faz Ölçüm V, A Cos ϕ , Hz, W, VA, Σ W, Σ VA, Σ VAr DIN	695,00	12
KAEL-MULTISER-11-DIN		750,00	12
KAEL-MULTISER-01-PC-DIN		710,00	12
KAEL-MULTISER-11-PC-DIN		825,00	12
KAEL-MULTISER-02-PC-DIN		877,00	12
KAEL-MULTISER-03-PC-DIN		990,00	12

MULTİMETRELER



KOD	AÇIKLAMA	AD. / ₺	K. AD.
KAEL-MULTIMET-01-96	3 Faz Ölçüm Güç Ölçer V, A Cos ϕ , Hz, W, VA, VAr 96 x 96	437,00	12
KAEL-MULTIMET 01-DIN	3 Faz Ölçüm V, A Cos ϕ , Hz	457,00	12
KAEL-MULTIMET-01-PC-96	3 Faz Ölçüm Güç Ölçer V, A, Hz, 96 x 96	525,00	12
KAEL-MULTIMET-01-PC-DIN	3 Faz Ölçüm V, A Hz	550,00	12
KAEL-MULTIMET-02-96	3 Faz Ölçüm V, A Hz, 96 x 96	450,00	12
KAEL-MULTIMET-02-DIN	3 Faz Ölçüm V, A Hz	480,00	12
KAEL-MULTIMET-02-R-96	3 Faz Ölçüm V, A Hz 96 x 96	510,00	12
KAEL-MULTIMET-02-R-DIN	3 Faz Ölçüm V, A Hz	590,00	12
KAEL-MULTIMET-03-96	3 Faz Ölçüm V, A Hz 96 x 96	310,00	12
KAEL-MULTIMET-03-144	3 Faz Ölçüm V, A Hz, 144 x 144	373,00	5
KAEL-MULTIMET-03-72	3 Faz Ölçüm V, A Hz, 72 x 72	389,00	10
KAEL-MULTIMET-03-DIN	3 Faz Ölçüm V, A Hz	346,00	6
KAEL-MULTIMET-04-DIN	Tek Faz Ölçüm V, A Hz	340,00	6

ENERJİ VE GÜÇ ÖLÇERLER



KOD	AÇIKLAMA	AD. / ₺	K. AD.
KAEL-ENERGY-01-DIN	Enerji Ölçer	814,00	12
KAEL-ENERGY-01-DIN-100A	Enerji Ölçer	958,00	12
KAEL-ENERGY-11-DIN	Enerji Ölçer	550,00	12
KAEL-ENERGY-11-DIN-100A	Enerji Ölçer	610,00	12
KAEL-ENERGY-02-PC-96	Enerji Ölçer	738,00	12
KAEL-ENERGY-02-PC-DIN	Enerji Ölçer	834,00	12
KAEL-POWER-01-96	Güç Ölçer	595,00	12
KAEL-POWER-01-DIN	Güç Ölçer	616,00	12

DİJİTAL AMPERMETRELER



KOD	AÇIKLAMA	AD. / ₺	K. AD.
KAEL - DAM-A-96	AC. (Demandlı) 5-10000 A. Akım Trafo Ayarı 220 V Besleme	198,00	12
KAEL - DAM-A-72	AC. (Demandlı) 5-10000 A. Akım Trafo Ayarı 220 V Besleme	198,00	10
KAEL - DAM-B-96	AC. (Demandlı) 5-10000 A. Akım Trafo Ayarı 220 V Besleme	205,00	12
KAEL - DAM-B-72	AC. (Demandlı) 5-10000 A. Akım Trafo Ayarı 220 V Besleme	205,00	10
KAEL - DAM-C-96	AC. (Demandlı) 5-10000 A. Akım Trafo Ayarı 220 V Besleme	224,00	12
KAEL - DAM-C-72	AC. (Demandlı) 5-10000 A. Akım Trafo Ayarı 220 V Besleme	224,00	10
KAEL - DAM-D-96	AC. 5-10000 A. Akım Trafo Ayarı 220 V Besleme	224,00	12
KAEL - DAM-D-72	AC. 5-10000 A. Akım Trafo Ayarı 220 V Besleme	224,00	10
KAEL - DAK-96	Direkt Ampermetre AC 1-100 A. 220 V Besleme	178,00	12
KAEL - DAK-72	Direkt Ampermetre AC 1-100 A. 220 V Besleme	178,00	10
KAEL - DAK-72-B	Direkt Ampermetre AC Aşırı Akım Setli 1-100 A. 220 V Besleme	212,00	10
KAEL - DAM-A-48	AC 5-10,000 A Akım Trafo Ayarı; 220 V Beslemeli	135,00	16
KAEL - DAK-A-48-PC	Direkt Ampermetre AC RS 485 Haberleşmeli	423,00	16

DİJİTAL VOLTMETRELER



KOD	AÇIKLAMA	AD. / ₺	K. AD.
KAEL - DV-96	Voltmetre AC ölçüm :0-500 Vac 220 V Beslemeli	168,00	12
KAEL - DV-96-03	Seçilebilir 3 faz Voltmetre AC ölçüm: 0-500 Vac	216,00	12
KAEL - DV-72	Voltmetre AC. 0-500 V. Beslemeli 72 x 72	168,00	10
KAEL - DV-72-01	Voltmetre AC. 0-500 V, Hz Beslemeli 72 x 72	193,00	10
KAEL - DV-72-03	Voltmetre AC. 0-500 V, Hz 220 V Beslemeli 72 x 72 Seçilebilir 3 Faz	210,00	10
KAEL - DV-72-01C	Gerilim ve Frekans Kontrol Cihazı, Aşırı Düşük Gerilim	200,00	10
KAEL - DV-72-03C	AC. 0-500 V, Hz 220 V Besle. 72 x 72 Seçilebilir 3 Faz Aşırı Düşük Gerilim Setli	243,00	10
KAEL - DV-72-R	Servo Regülatör Kontrol Cihazı 0-500 Vac 220 V Beslemeli	185,00	10
KAEL - DV-72-RR	Servo Regülatör Kontrol Cihazı 0-500 Vac 220 V Besle. Aşırı ve Düşük Gerilim Setli	191,00	10
KAEL - DV-03-(D)	Seçilebilir 3 Faz Voltmetre AC + Frekansmetre Ölçüm: 0-500 Vac - 40-100 Hz	170,00	10
KAEL - DV-48-01	Voltmetre AC ölçüm: 0-500 Vac ; 220 V Beslemeli	155,00	16
KAEL - DV-48-03	Seçilebilir 3 Faz Voltmetre AC Ölçüm: 0-500 V, 220 Z Beslemeli	178,00	16

ASTRONOMİK ZAMAN SAATLERİ



KOD	AÇIKLAMA	AD. / ₺	K. AD.
KAEL-ASTRO-30	Astronomik ve/veya Zaman Saati (8 A)	250,00	26
KAEL-ASTRO-31	Astronomik ve/veya Zaman Saati (16 A)	288,00	26
KAEL-ASTRO-01	Astronomik ve/veya Zaman Saati (8 A), Infrared Alıcı	295,00	26
KAEL-ASTRO-03	Astronomik ve/veya Zaman Saati (8 A), Infrared Alıcı	311,00	26
KAEL-ASTRO-05	Astronomik ve/veya Zaman Saati (8 A), Infrared Alıcı	345,00	26
KAEL-ASTRO-11	Astronomik ve/veya Zaman Saati (16 A), Infrared Alıcı	315,00	26
KAEL-ASTRO-13	Astronomik ve/veya Zaman Saati (16 A), Infrared Alıcı	330,00	26
KAEL-ASTRO-15	Astronomik ve/veya Zaman Saati (16 A), Infrared Alıcı	380,00	26
KAEL-ASTRO-13-RS485	Astronomik ve/veya Zaman Saati (16 A), Infrared Alıcı, RS 485 Çıkışlı	445,00	16
KAEL-ASTRO-01-GPS	Astronomik ve/veya Zaman Saati (5 A) Dahili GPS Anten	330,00	10
KAEL-ASTRO-02-GPS	Astronomik ve/veya Zaman Saati (10 A) Harici GPS Anten	445,00	10
KAEL-CR 2032	Pil	12,00	1
KAEL-LIR 2032	Şarjlı Pil	17,00	1

GERİLİM ve AKIM KORUMA RÖLELERİ



KOD	AÇIKLAMA	AD. / ₺	K. AD.
KAEL-Ke-DP01	Trifaze Gerilim ve Akım Kontrol Rölesi DIN RAIL, 3 Fazlı	430,00	16
KAEL-Ke-DP01-100A	Trifaze Gerilim ve Akım Kontrol Rölesi DIN RAIL, 3 Fazlı	537,00	16
KAEL-Ke-DP02	Monofaze Gerilim ve Akım Kontrol Rölesi DIN RAIL, Tek Faz	366,00	16
KAEL-Ke-DP02-100A	Monofaze Gerilim ve Akım Kontrol Rölesi, Tek Fazlı	400,00	16
KAEL-DP01-72	Trifaze Gerilim ve Akım Kontrol Rölesi, 3 Fazlı	455,00	10
KAEL-DP01-72-100A	Trifaze Gerilim ve Akım Kontrol Rölesi, 3 Fazlı	605,00	12
KAEL-DP02-72	Monofaze Gerilim ve Akım Kontrol Rölesi 72 x 72, Tek Faz	382,00	10
KAEL-DP02-72-100A	Monofaze Gerilim ve Akım Kontrol Rölesi 72 x 72, Tek Faz	425,00	12

SEVİYE KONTROL RÖLELERİ



KOD	AÇIKLAMA	AD. / ₺	K. AD.
KAEL-Ke-SKR	Seviye Kontrol Rölesi, Hassasiyet Ayarlı (5-100 Ω)	85,00	8
KAEL-SKR-DIN	Seviye Kontrol Rölesi, Hassasiyet Ayarlı (5-100 Ω)	83,00	26
KAEL-SE	Serbest Elektrod	22,00	1

AKIM KORUMA RÖLELERİ



KOD	AÇIKLAMA	AD. / ₺	K. AD.
KAEL-OCM-01	Aşırı Akım Koruma Rölesi, Akım Ayarı: 0,5 - 5A	182,00	26
KAEL-OCM-03	Aşırı Akım Koruma Rölesi, Akım Ayarı: 10 - 100A	195,00	26
KAEL-UCM-01	Aşırı Akım Koruma Rölesi, Akım Ayarı: 0,5 - 5A	150,00	26
KAEL-UCM-03	Aşırı Akım Koruma Rölesi, Akım Ayarı: 10 - 100A	190,00	26

ZAMAN RÖLELERİ



KOD	AÇIKLAMA	AD. / ₺	KO. AD.
KAEL-ZRMX.G	Mod Seçimli Çok Fonksiyonlu Zaman Rölesi, Gold Serisi	187,00	10
KAEL-ZRXX.G	Çok Fonksiyonlu Zaman Rölesi, Gold Serisi	84,00	10
KAEL-ZR30.G	30 sn Zaman Rölesi, Gold Serisi	68,00	10
KAEL-ZR60.G	60 sn Zaman Rölesi, Gold Serisi	70,00	10
KAEL-DRN.G	Çift Ayarlı Flaşör Röle, Gold Serisi	92,00	10
KAEL-ZRSS.G	Sağ - Sol Rölesi, Gold Serisi	115,00	10
KAEL-SD.G	Yıldız - Üçgen Rölesi, Gold Serisi	100,00	10
KAEL-DG60.G	Düşmede Gecikmeli Zaman Rölesi, Gold Serisi	270,00	10
KAEL-HSRG	Çok Fonksiyonlu Hidrofor Sıralama Rölesi	198,00	10
KAEL-ke-DRN1	Çift Ayarlı Flaşör Röle (On Start)	106,00	10
KAEL-ke-DRN2	Çift Ayarlı Flaşör Röle (Off Start)	106,00	10
KAEL-ke-FRXX	Flaşör Röle (On Start)	91,00	10
KAEL-ke-SS1	Sağ - Sol Rölesi (On Start)	105,00	10
KAEL-ke-SS2	Sağ - Sol Rölesi (Off Start)	105,00	10
KAEL-ke-SD	Yıldız - Üçgen Rölesi	95,00	10
KAEL-ke-ZR30	30 sn Zaman Rölesi	70,00	10
KAEL-ke-ZR60	60 sn Zaman Rölesi	70,00	10
KAEL-ke-ZRXX	Çok Fonksiyonlu Zaman Rölesi	95,00	10
KAEL-ke-ZRXX (D)	Dijital Çok Fonksiyonlu Zaman Rölesi	185,00	10
KAEL-ke-ZRC	Sayıcı Fonksiyonlu Zaman Rölesi	190,00	10
KAEL-YMR-5-T	Yıkama Makinesi Rölesi	175,00	10

FAZ KORUMA RÖLELERİ



KOD	AÇIKLAMA	AD. / ₺	K. AD.
KAEL-FKR1.G	Faz Koruma Rölesi	75,00	10
KAEL-FKR2.G.4W	Faz Sıralama Rölesi	120,00	10
KAEL-FKR2.G.3W	Faz Sıralama Rölesi (Nötrsüz)	125,00	10
KAEL-FKR1	Faz Koruma Rölesi	80,00	8
KAEL-FKR1T	PTC'li Faz Koruma Rölesi	122,00	8
KAEL-FKR2	Faz Sıralamalı Faz Koruma Rölesi	195,00	8
KAEL-FKR3	Faz Sıralamalı Faz Koruma Rölesi	170,00	8
KAEL-FKR4	Faz Sıralamalı Faz Koruma Rölesi	180,00	26
KAEL-FKR1-DIN	Faz Koruma Rölesi	80,00	26
KAEL-FKR1T-DIN	PTC'li Faz Koruma Rölesi	84,00	26
KAEL-FKR2-DIN	NÖTR'süz Faz Sıralamalı Faz Koruma Rölesi	110,00	26
KAEL-FKR2T-DIN	NÖTR'süz PTC'li Faz Sıralamalı Faz Koruma Rölesi	129,00	26
KAEL-FKR3-DIN	NÖTR'süz Faz Sıralamalı Faz Koruma Rölesi	135,00	26
KAEL-FKR3T-DIN	NÖTR'süz PTC'li Faz Sıralamalı Faz Koruma Rölesi	139,00	26
KAEL-FKR2N-DIN	Faz Sıralamalı Faz Koruma Rölesi	98,00	26
KAEL-FKR3N-DIN	Faz Sıralamalı Faz Koruma Rölesi	162,00	26
KAEL-FKR4N-DIN	Faz Sıralamalı Faz Koruma Rölesi	190,00	26
KAEL-FKR4.4W	Faz Sıralamalı Faz Koruma Rölesi	162,00	26
KAEL-FKR4.3W	Faz Sıralamalı Faz Koruma Rölesi	180,00	26
KAEL-KE-FKR4D-DIN	Faz Sıralamalı Faz Koruma Rölesi	190,00	26
KAEL-PSC.G.4W	Faz Sırası Kontrol Cihazı	135,00	26

AŞIRI VE DÜŞÜK GERİLİM KORUMA RÖLELERİ



KOD	AÇIKLAMA	AD. / ₺	K. AD.
KAEL-ADG3X	Aşırı ve Düşük Gerilim Koruma Rölesi (Trifaze)	205,00	26
KAEL-ADG3FN	Aşırı ve Düşük Gerilim Koruma Rölesi (Trifaze)	199,00	26
KAEL-ADG3FN-G	Aşırı ve Düşük Gerilim Koruma Rölesi (Trifaze)	205,00	26
KAEL-ADG3F	Aşırı ve Düşük Gerilim Koruma Rölesi (Trifaze)	215,00	26
KAEL-ADG3F-G	Aşırı ve Düşük Gerilim Koruma Rölesi (Trifaze)	210,00	26
KAEL-ADG3N	Aşırı ve Düşük Gerilim Koruma Rölesi (Trifaze)	195,00	26
KAEL-ADG3	Aşırı ve Düşük Gerilim Koruma Rölesi (Trifaze)	193,00	26
KAEL-ADG1	Aşırı ve Düşük Gerilim Koruma Rölesi (Monofaze)	145,00	26
KAEL-ADG1-G	Aşırı ve Düşük Gerilim Koruma Rölesi (Monofaze)	173,00	26
KAEL-ADG1-NC	Aşırı ve Düşük Gerilim Koruma Rölesi (Monofaze) (Ters Çalışma)	207,00	26
KAEL-ADG31-DIN	Aşırı ve Düşük Gerilim Koruma Rölesi (Trifaze)	215,00	26
KAEL-ADG33-DIN	Aşırı ve Düşük Gerilim Koruma Rölesi (Trifaze)	218,00	26
KAEL-ADG37-DIN	Aşırı ve Düşük Gerilim Koruma Rölesi (Trifaze)	222,00	26
KAEL-ke-ADG31	Aşırı ve Düşük Gerilim Koruma Rölesi (Trifaze)	194,00	10
KAEL-ke-ADG33	Aşırı ve Düşük Gerilim Koruma Rölesi (Trifaze)	198,00	10
KAEL-ke-ADG37	Aşırı ve Düşük Gerilim Koruma Rölesi (Trifaze)	205,00	10
KAEL-ke-ADG11	Aşırı ve Düşük Gerilim Koruma Rölesi (Monofaze)	142,00	10
KAEL-ke-ADG15	Aşırı ve Düşük Gerilim Koruma Rölesi (Monofaze)	142,00	10

ÖZEL RÖLELER



KOD	AÇIKLAMA	AD. / ₺	K. AD.
KAEL-EK96	Elektronik Korna, Panel Tipi 96 x 96	213,00	12
KAEL-HSR2	Hidrafor Sıralama Rölesi (2 Çıkışlı)	195,00	10
KAEL-HSR3	Hidrafor Sıralama Rölesi (3 Çıkışlı)	202,00	10
KAEL-ke-HSR2	Hidrafor Sıralama Rölesi (2 Çıkışlı)	164,00	10
KAEL-ke-HSR3	Hidrafor Sıralama Rölesi (3 Çıkışlı)	180,00	10
KAEL-ke-TKR1	Termistör Koruma Rölesi	121,00	10
KAEL-IRK-06	İhbar Röle Kombinasyonu (6 Açma İhbarı, 4 İhbar)	835,00	1
KAEL-IRK-10	İhbar Röle Kombinasyonu (10 Açma İhbarı)	925,00	1
KAEL-AR24	Redresör (Bakımsız Akülü), 24 V / 7 Ahr	1.960,00	1
KAEL-AR24-14A	Redresör (Bakımsız Akülü), 24 V / 14 Ahr	3.200,00	1
KAEL-SEK-01	Sekonder Koruma Rölesi, 3 Faz 1 Toprak, LCD Ekranlı	1.600,00	1
KAEL-PFM	Aşırı ve Düşük Kompanzasyon Alarm Cihazı	355,00	26
KAEL-CLN-01	Filtre Temizlik Kontrol Cihazı	1.100,00	26

FOTOSEL RÖLELER



KOD	AÇIKLAMA	AD. / ₺	K. AD.
KAEL-FTR	Fotosel Röle (Göz Dahil), Lux Ayarlı, Röle Çıkışlı	95,00	10
KAEL-ke-FTR	Fotosel Röle (Göz Dahil), Lux Ayarlı, Röle Çıkışlı	95,00	8
KAEL-ke-FTR10M	Fotosel Röle (Göz Dahil), 1 - 10 Lux Ayarlı, El Kumandalı Röle Çıkışlı	120,00	8
KAEL-FTG	Fotosel Göz	48,00	1

COS Ø METRE ve FREKANSMETRELER



KOD	AÇIKLAMA	AD. / ₺	K. AD.
KAEL - DC 96	Cos Ø Metre. 220 VAC Beslemeli	162,00	12
KAEL - DF-72	Dijital Frekansmetre 440-400 Hz 220-400 Vac 72 x 72	159,00	10
KAEL - DF-96	Dijital Frekansmetre 40-400 Hz 220-400 Vac 96 x 96	165,00	12
KAEL - DF-48	Dijital Frekansmetre 40-400 Hz 220-400 Vac 48 x 96	180,00	16

SICAKLIK KONTROL CİHAZLARI



KOD	AÇIKLAMA	AD. / ₺	K. AD.
KAEL - TC-PT100	Sıcaklık Cihazı	1.430,00	-
KAEL - TC-PT100-AS	Sıcaklık Cihazı	1.575,00	-
KAEL - PT100 -KS	Sıcaklık Sensörü	160,00	-
KAEL - BOX-KS	Dağıtım Kutusu	224,00	-

FTCG

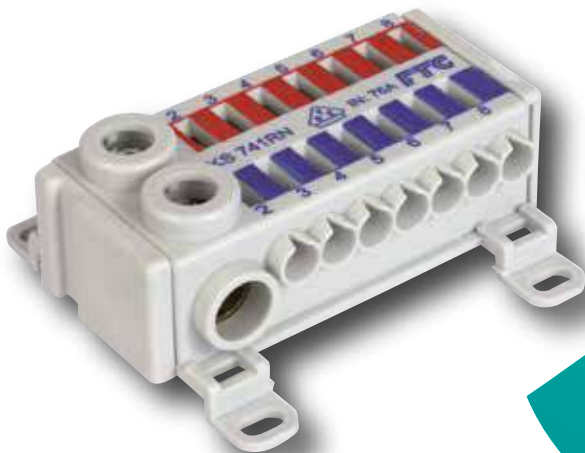

GÜÇ DAĞITIM BLOKLARI

MONOBLOK DAĞITICI

KOD	CİNSİ	AD. / €	K. / AD.
FTG-38049	80 A, Giriş: 1 x 2,5-16 mm ² Çıkış: 4 x 2,5 - 6 mm ² 2 x 2,5 - 16 mm ²	14,37 €	1
FTG-38049 PE	80 A Yeşil Giriş: 1 x 2,5 - 16 mm ² Çıkış: 4 x 2,5 - 6 mm ² 2 x 2,5 - 16 mm ²	14,37 €	1
FTG-38049 N	80 A Mavi Giriş: 1 x 2,5 - 16 mm ² Çıkış: 4 x 2,5 - 6 mm ² 2 x 2,5 - 16 mm ²	14,37 €	1
FTG-38041	125 A, Giriş: 1 x 10-35 mm ² 1 x 6 - 16 mm ² Çıkış: 6 x 2,5 - 16 mm ²	27,50 €	1
FTG-38041 PE	125 A, Giriş: 1 x 10-35 mm ² 1 x 6 - 16 mm ² Çıkış: 6 x 2,5 - 16 mm ²	27,50 €	1
FTG-38041 N	125 A, Giriş: 1 x 16-35 mm ² 1 x 6 - 16 mm ² Çıkış: 6 x 2,5 - 16 mm ²	27,50 €	1
FTG-38076	125 A, Giriş: 1 x 16-35 mm ² Çıkış: 10 x 2,5 - 16 mm ²	40,63 €	1
FTG-38074	175 A, Giriş: 1 x 16-70 mm ² Çıkış: 10 x 2,5 - 16 mm ²	40,63 €	1
FTG-38074 N	175 A Mavi Giriş: 1 x 16 - 70 mm ² Çıkış: 10 x 2,5 - 16 mm ²	40,63 €	1
FTG-38032	160 A, Giriş: 1 x 10-70 mm ² Çıkış: 6 x 2,5 - 16 mm ² Bakır Bara Geçişli	41,88 €	1
FTG-38020	250 A Giriş: 1 x 35 - 120 mm ² Çıkış: 2 x 6 - 35 mm ² 5 x 1,5 - 16 mm ² 4x1,5-10 mm ²	55,00 €	1
FTG-38019	400 A, Giriş: 1x95-185 mm ² Çıkış: 2 x 6 - 35 mm ² 5 x 1,5 - 16 mm ² 4 x 1,5 - 10 mm ²	58,75 €	1

MONOBLOK DAĞITICI

KOD	CİNSİ	AD. / €	K. / AD.
FTG-38404	400 A Giriş: 1 x 70 - 240 mm ² Çıkış: 2 x 35 - 120 mm ²	62,50 €	1
FTG-38404N	400 A Giriş: 1 x 70 - 240 mm ² Çıkış: 2 x 35 - 120 mm ²	62,50 €	1
FTG-38404PE	400 A Giriş: 1 x 70 - 240 mm ² Çıkış: 2 x 35 - 120 mm ²	62,50 €	1
FTG-38404R	400 A Giriş: 1 x 70 - 240 mm ² Çıkış: 2 x 35 - 120 mm ²	62,50 €	1
FTG-38403	400 A Giriş: 1 x 70 - 240 mm ² Çıkış: 6 x 6 - 50 mm ²	62,50 €	1
FTG-38403N	400 A Giriş: 1 x 70 - 240 mm ² Çıkış: 6 x 6 - 50 mm ²	62,50 €	1
FTG-38403PE	400 A Giriş: 1 x 70 - 240 mm ² Çıkış: 6 x 6 - 50 mm ²	62,50 €	1
FTG-38403R	400 A Giriş: 1 x 70 - 240 mm ² Çıkış: 6 x 6 - 50 mm ²	62,50 €	1
FTG-38402	400 A Bara Girişi : 20 x 4 - 25 x 10 mm Çıkış: 2 x 35 - 120 mm ²	62,50 €	1
FTG-38401	400 A Bara Girişi :15,5 x 0,8 x 1 mm 24 x 1 x 6 mm Çıkış: 6 x 6 - 50 mm ²	63,75 €	1
FTG-38062	800 A Bara Girişi 1 x 35 - 300 mm Bara Geniřliđi : 50 mm Çıkış 2 x 35 - 300 mm ²	81,25 €	1
FTG-38063	800 A Bara Girişi 2 x 35 - 300 mm Bara Geniřliđi : 20 mm Çıkış 2 x 35 - 300 mm ²	81,25 €	1

3 FAZLI MONOBLOK DAĞITICI



KOD	CİNSİ	AD. / €	K. / AD.
FTG-38056	125 A, (3 FAZ + NÖTR) Giriş: 1 x 10 - 35 mm ² Çıkış: 5 x 1,5 - 6, 2 x 2,5 - 16mm ²	38,13 €	1
FTG-38075	125 A, (3 FAZ) Giriş: 1 x 10 - 35 mm ² Çıkış: 6 x 2,5 - 16 mm ²	78,13 €	1
FTG-38073	175 A, (3 FAZ) Giriş: 1 x 16 - 70 mm ² Çıkış: 6 x 2,5 - 16 mm ²	71,25 €	1

GÜÇ DAĞITIM BLOĞU (950 A)

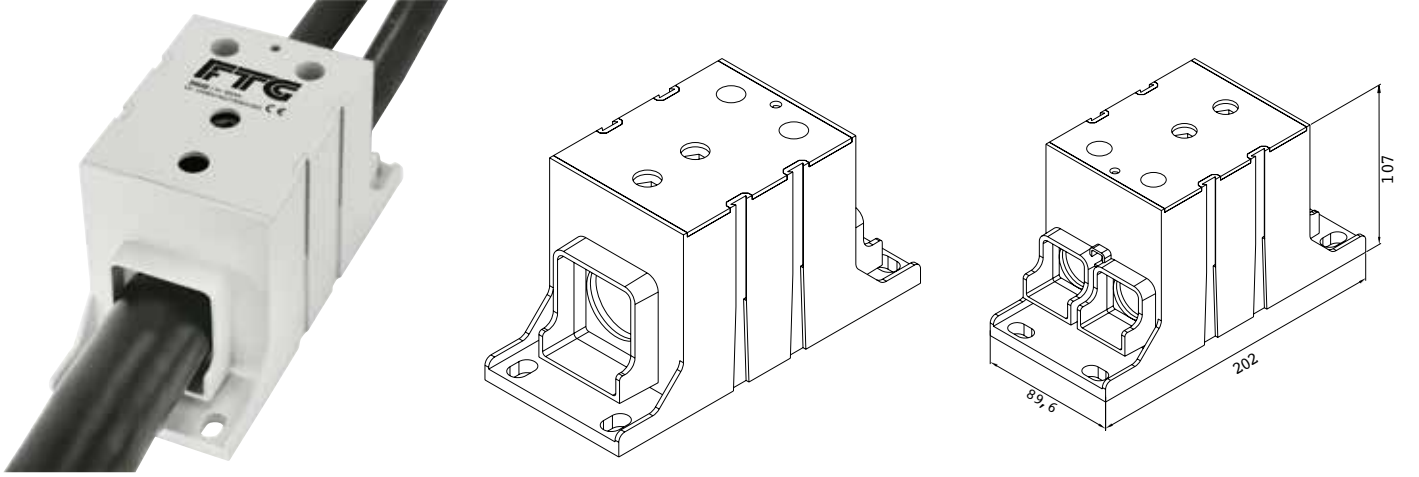

KOD	CİNSİ	RENK	ADET / €	K. AD.
FTG-38650	950 A Giriş: 1 x 95 - 500 mm ² Çıkış: 2 x 50 - 300 mm ²	Gri	695,00 €	1
FTG-38650N		Mavi	695,00 €	1
FTG-38650PE		Yeşil	695,00 €	1
FTG-38650R		Kırmızı	695,00 €	1

TRANSPARAN KAPAKLI GÜÇ DAĞITIM BLOKLARI

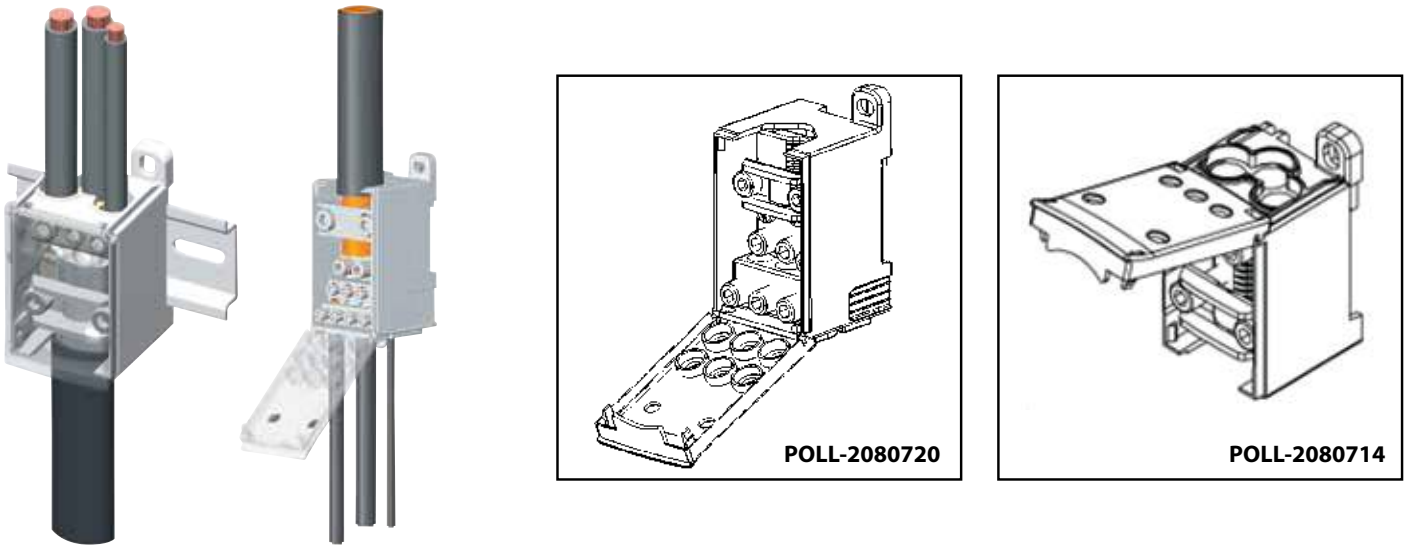

KOD	CİNSİ	ADET / €	K. AD.
POLL-2080720	160 A Giriş: 1 x 16 - 70 mm ² , Çıkış: 6 x 2,5 - 35 mm ²	32,63 €	5
POLL-2080714	250 A Giriş: 1 x 50 - 150 mm ² , Çıkış: 3 x 2,5 - 35 mm ²	34,00 €	5
POLL-2080718	250 A Giriş: 1 x 35 - 120 mm ² , Çıkış: 3 x 2,5 - 35 mm ² , Çıkış: 8 x 2,5 - 16 mm ²	44,75 €	5
POLL-2080719	400 A Giriş: 1 x 95 - 185 mm ² , Çıkış: 4 x 10 - 70 mm ² , Çıkış: 8 x 2,5 - 16 mm ²	47,63 €	5
POLL-2080723	500 A Giriş: 1 x 150 - 240 mm ² , Çıkış: 4 x 10 - 70 mm ² , Çıkış: 4 x 2,5 - 16 mm ²	54,25 €	5

PRATİK GÜÇ DAĞITIM BLOĞU

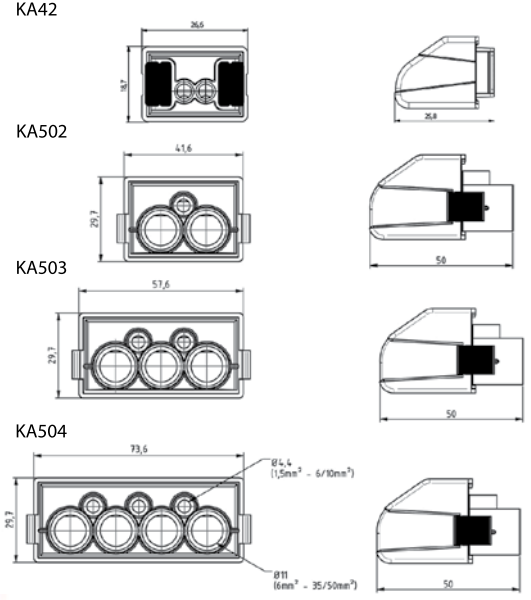

KA42



KA502



KA503N



KA504PE

KOD	cinsi	ADET / €	K. AD.
KA42	690 V AC, 0,75 - 4 mm ² , 25A(Cu), 125A(AL)	7,44 €	1
KA502	1000 V DC, 690 V AC, 2 x 6-35 mm ² , 160A(Cu), 125A(AL)	10,02 €	1
KA502N	1000 V DC, 690 V AC, 2 x 6-35 mm ² , 160A(Cu), 125A(AL)	10,02 €	1
KA502PE	1000 V DC, 690 V AC, 2 x 6-35 mm ² , 160A(Cu), 125A(AL)	10,02 €	1
KA503	1000 V DC, 690 V AC, 3 x 6-35 mm ² , 160A(Cu), 125A(AL)	11,25 €	1
KA503N	1000 V DC, 690 V AC, 3 x 6-35 mm ² , 160A(Cu), 125A(AL)	11,25 €	1
KA503PE	1000 V DC, 690 V AC, 3 x 6-35 mm ² , 160A(Cu), 125A(AL)	11,25 €	1
KA504	1000 V DC, 690 V AC, 4 x 6-35 mm ² , 160A(Cu), 125A(AL)	19,90 €	1
KA504N	1000 V DC, 690 V AC, 4 x 6-35 mm ² , 160A(Cu), 125A(AL)	19,90 €	1
KA504PE	1000 V DC, 690 V AC, 4 x 6-35 mm ² , 160A(Cu), 125A(AL)	19,90 €	1

TAM İZOLELİ DAĞITICI ÜNİTELER (MÜHÜRLÜ KAPAK)

KOD	cinsi	ADET / €	K. / AD.
FTG-38814	Gri Renk, 250A, 1000 V DC, 690 V AC Giriş: 1 x 25 - 95 mm ² - 1 x 35 - 120 mm ² , Çıkış: 4 x 1.5 - 10 mm ² - 4 x 1.5 - 16 mm ²	38,75 €	1
FTG-38814N	Mavi Renk, 250A, 1000 V DC, 690 V AC Giriş: 1 x 25 - 95 mm ² - 1 x 35 - 120 mm ² , Çıkış: 4 x 1.5 - 10 mm ² - 4 x 1.5 - 16 mm ²	38,75 €	1
FTG-38814PE	Yeşil Renk, 250A, 1000 V DC, 690 V AC Giriş: 1 x 25 - 95 mm ² - 1 x 35 - 120 mm ² , Çıkış: 4 x 1.5 - 10 mm ² - 4 x 1.5 - 16 mm ²	38,75 €	1
FTG-38814R	Kırmızı Renk, 250A, 1000 V DC, 690 V AC Giriş: 1 x 25 - 95 mm ² - 1 x 35 - 120 mm ² , Çıkış: 4 x 1.5 - 10 mm ² - 4 x 1.5 - 16 mm ²	38,75 €	1

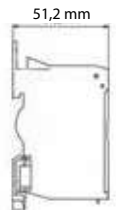
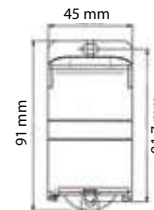

EK ALMA KLEMENSLERİ



KOD	CİNSİ	AD./ €	K. / AD.
FTG-KN T 1316İ	3 x 1,5-10 mm ² İzoleli	11,25 €	1
FTG-KN T 1316IU	3 x 1,5-16 mm ² İzoleli	13,13 €	1

VİDA VE YAY BASKILI MODÜLER SİSTEM DAĞITICI ÜNİTE



KOD	CİNSİ	AD./ €	K. / AD.
FTG-KS741	2 x 25 mm ² - 14 x 4 mm ² 76A / 690V / Gri	9,38 €	10
FTG-KS741N	2 x 25 mm ² - 14 x 4 mm ² 76A / 690V / Mavi	9,38 €	10
FTG-KS741PE	2 x 25 mm ² - 14 x 4 mm ² 76A / 690V / Yeşil	9,38 €	10
FTG-KS741NPE	1 x 16 mm ² - 7 x 4 mm ² 76A / 690V / Mavi Yeşil	9,38 €	10
FTG-KS741NN	1 x 16 mm ² - 7 x 4 mm ² 76A / 690V / Mavi	9,38 €	10
FTG-KS741RN	1 x 16 mm ² - 7 x 4 mm ² 76A / 690V / Kırmızı Mavi	9,38 €	10

TEK GİRİŞ TEK ÇIKIŞ DAĞITICI



KOD	CİNSİ	GİRİŞ ÇIKIŞ	KABLO KESİTİ ARALIĞI	AKIM		AD. / €	K. / AD.
				CU	AL		
FTG-KVIAC11150G	25 - 150 mm ² Gri	1/1	25 - 150 mm ²	315	250	26,88 €	20
FTG-KVIAC11150B	25 - 150 mm ² Mavi	1/1	25 - 150 mm ²	315	250	26,88 €	10
FTG-KVIAC11150YG	25 - 150 mm ² Sarı / Yeşil	1/1	25 - 150 mm ²	315	250	26,88 €	10
FTG-KVIAC11240G	35 - 240 mm ² Gri	1/1	35 - 240 mm ²	400	315	50,00 €	10
FTG-KVIAC11240B	35 - 240 mm ² Sarı / Mavi	1/1	35 - 240 mm ²	400	315	50,00 €	3
FTG-KVIAC11240YG	35 - 240 mm ² Sarı / Yeşil	1/1	35 - 240 mm ²	400	315	50,00 €	3

İKİ GİRİŞ İKİ ÇIKIŞ DAĞITICI



KOD	CİNSİ	GİRİŞ ÇIKIŞ	KABLO KESİTİ ARALIĞI	AKIM		AD. / €	K. / AD.
				CU	AL		
FTG-KVIAC12035G	2.5 - 35 mm ² Gri	2/2	6 - 35 mm ²	2 x 125	100	23,75 €	30
FTG-KVIAC12035B	2.5 - 35 mm ² Mavi	2/2	6 - 35 mm ²	2 x 125	100	23,75 €	15
FTG-KVIAC12035YG	2.5 - 35 mm ² Sarı / Yeşil	2/2	6 - 35 mm ²	2 x 125	100	23,75 €	15
FTG-KVIAC12050G	2.5 - 50 mm ² Gri	2/2	2.5 - 50 mm ²	2 x 160	125	19,38 €	15
FTG-KVIAC12050B	2.5 - 50 mm ² Mavi	2/2	2.5 - 50 mm ²	2 x 160	125	19,38 €	15
FTG-KVIAC12050YG	2.5 - 50 mm ² Sarı / Yeşil	2/2	2.5 - 50 mm ²	2 x 160	125	19,38 €	15
FTG-KVIAC12095G	6 - 95 mm ² Gri	2/2	6 - 95 mm ²	2 x 250	200	33,13 €	30
FTG-KVIAC12095B	6 - 95 mm ² Mavi	2/2	6 - 95 mm ²	2 x 250	200	33,13 €	15
FTG-KVIAC12095YG	6 - 95 mm ² Sarı / Yeşil	2/2	6 - 95 mm ²	2 x 250	200	33,13 €	15
FTG-KVIAC12150G	2 x 25-150 mm ² Gri	2/2	25 - 150 mm ²	2 x 315	250	60,00 €	1
FTG-KVIAC12150B	25 - 150 mm ² Mavi	2/2	25 - 150 mm ²	2 x 315	250	60,00 €	5
FTG-KVIAC12150YG	25 - 150 mm ² Sarı / Yeşil	2/2	25 - 150 mm ²	2 x 315	250	60,00 €	5

İKİ GİRİŞ İKİ ÇIKIŞ ALTERNATİFLERİ



KVIAC12050YG

KOD	CİNSİ	GİRİŞ ÇIKIŞ	KABLO KESİTİ ARALIĞI	AKIM		AD. / €	K. / AD.
				CU	AL		
FTG-KVIAC12240G	2 Giriş, 2 Çıkış, 2 x 35-240 mm ² Gri	2 / 2	35 - 240 mm ²	2 x 400	315	93,75 €	1
FTG-KVIAC12240B	35 - 240 mm ² Mavi	2 / 2	35 - 240 mm ²	2 x 400	315	101,25 €	3
FTG-KVIAC12240YG	35 - 240 mm ² Sarı / Yeşil	2 / 2	35 - 240 mm ²	2 x 400	315	101,25 €	3

ÜÇ GİRİŞ ÜÇ ÇIKIŞ DAĞITICI



KOD	CİNSİ	GİRİŞ ÇIKIŞ	KABLO KESİTİ ARALIĞI	AKIM		AD. / €	K. / AD.
				CU	AL		
FTG-KVIAC31050G	2.5 - 50 mm ² Gri	3 x 1 / 3 x 1	2.5 - 50 mm ²	3 x 160	125	25,00 €	20

DİĞER GİRİŞ ÇIKIŞ ALTERNATİFLERİ



KVIAC51016G

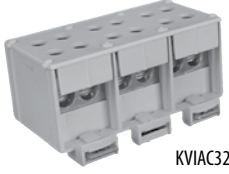

KVIAC32035G

KOD	CİNSİ	GİRİŞ ÇIKIŞ	KABLO KESİTİ ARALIĞI	AKIM		AD. / €	K. / AD.
FTG-KVIAC14016G	2,5 - 16 mm ² Gri	4 x Flexibel	2,5 - 16 mm ²	200	160	21,25 €	30
FTG-KVIAC14016B	2,5 - 16 mm ² Mavi	4 x Flexibel	2,5 - 16 mm ²	200	160	22,50 €	15
FTG-KVIAC14016YG	2,5 - 16 mm ² Sarı / Yeşil	4 x Flexibel	2,5 - 16 mm ²	200	160	22,50 €	15
FTG-KVIAC51016G	2,5 - 16 mm ² Gri	5 x 1 / 5 x 1	2,5 - 16 mm ²	5 x 80	63	32,50 €	10
FTG-KVIAC51016B	2,5 - 16 mm ² Mavi	5 x 1 / 5 x 1	2,5 - 16 mm ²	5 x 80	63	33,75 €	30
FTG-KVIAC51016YG	2,5 - 35 mm ² Yeşil	5 x 1 / 5 x 1	2,5 - 35 mm ²	5 X 80	63	33,75 €	30
FTG-KVIAC32035G	2,5 - 35 mm ² Gri	3 x 2 / 3 x 2	2,5 - 35 mm ²	3x2 x 160	125	51,25 €	1

TAM İZOLELİ DAĞITICI ÜNİTELER



KOD	CİNSİ	AD. / €	K. / AD.
FTG-38811	125A, GRİ Giriş: 2 x 10 - 35, Çıkış: 2 x 2,5 - 25,6 x 1,5 - 16	30,63 €	10
FTG-38811N	125A, MAVİ Giriş: 2 x 10 - 35, Çıkış: 2 x 2,5 - 25,6 x 1,5 - 16	30,63 €	5
FTG-38811PE	125A, YEŞİL Giriş: 2 x 10 - 35, Çıkış: 2 x 2,5 - 25,6 x 1,5 - 16	30,63 €	5
FTG-38811R	125A, KIRMIZI Giriş: 2 x 10 - 35, Çıkış: 2 x 2,5 - 25,6 x 1,5 - 16	30,63 €	6
FTG-38812	160A, GRİ Giriş: 2 x 25 - 70, Çıkış: 3 x 2,5 - 25, 8 x 1,5 - 16	33,75 €	3
FTG-38812N	160A, MAVİ Giriş: 2 x 25 - 70, Çıkış: 3 x 2,5 - 25, 8 x 1,5 - 16	33,75 €	3
FTG-38812PE	160A, YEŞİL Giriş: 2 x 25 - 70, Çıkış: 3 x 2,5 - 25, 8 x 1,5 - 16	33,75 €	30
FTG-38812R	160A, KIRMIZI Giriş: 2 x 25 - 70, Çıkış: 3 x 2,5 - 25, 8 x 1,5 - 16	33,75 €	15

KOMPLE İZOLELİ DAĞITICI ÜNİTELER



KOD	CİNSİ	KABLO KESİTİ	AD. / €	K. / AD.
FTG-870 N/7FS	7 x 16 mm ² Mavi Komple İzoleli Dağıtıcı Ünite	16 mm ²	3,13 €	10
FTG-870 S/7FS	7 x 16 mm ² Yeşil/Sarı Komple İzoleli Dağıtıcı Ünite	16 mm ²	3,13 €	10
FTG-870 N/15S	15 x 16 mm ² Mavi Komple İzoleli Dağıtıcı Ünite	16 mm ²	5,63 €	10
FTG-870 S/15S	15 x 16 mm ² Yeşil/Sarı Komple İzoleli Dağıtıcı Ünite	16 mm ²	5,63 €	10

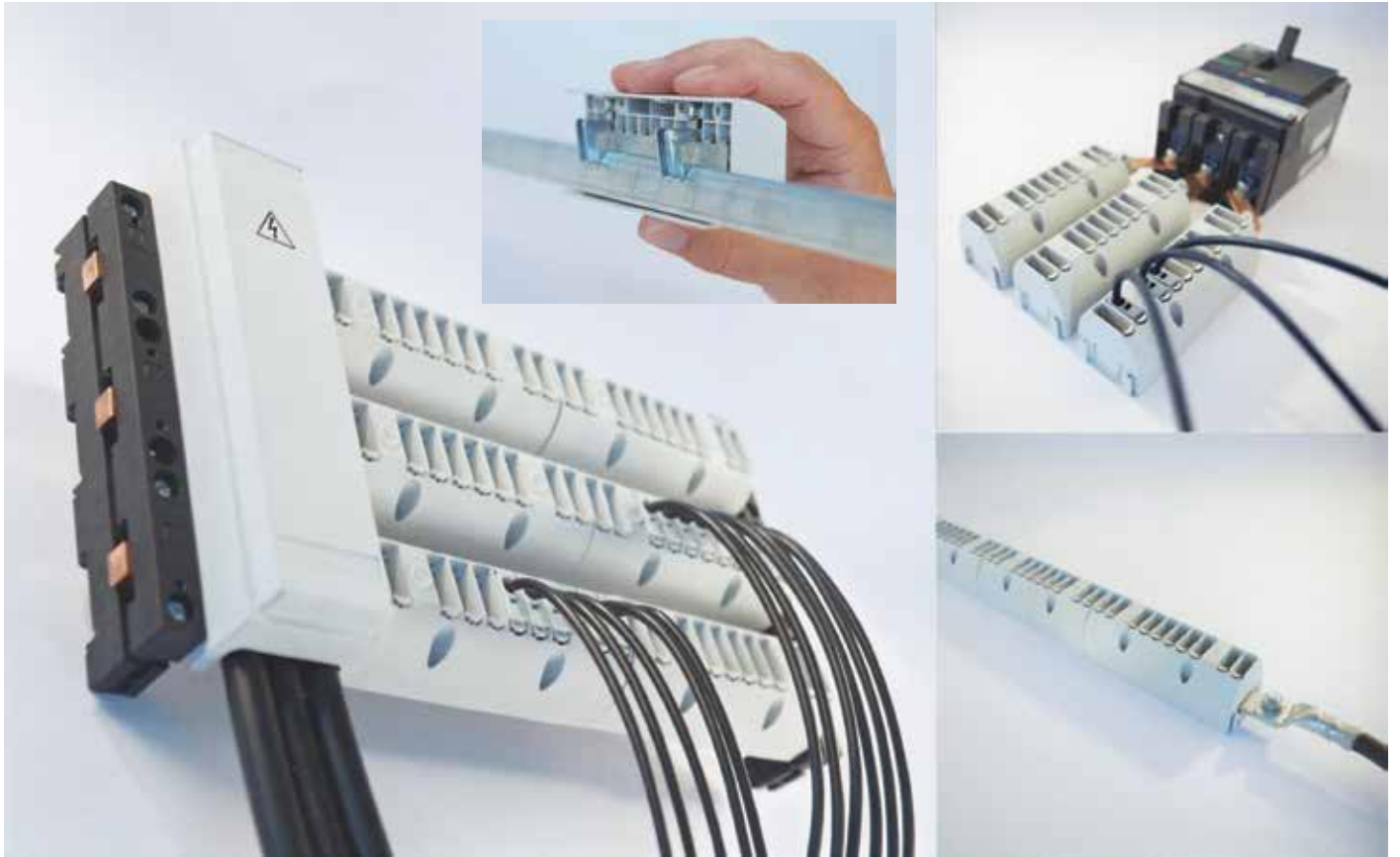

PUSH IN

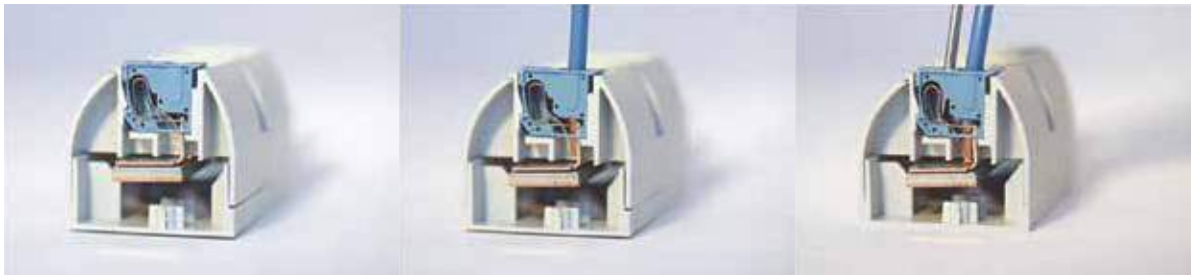

MINI CLIC



KOD	ÇİNSİ	AD. / €	K. / AD.
FTG-MC 22001	Mini Clic Basis	20,63 €	1
FTG-MC 22002	Mini Clic Incomer, Giriş 25 - 120 mm ²	53,13 €	1
FTG-MC 22003	Mini Clic Pin, Giriş M8	35,63 €	1
FTG-MC 00001	Mini Clic Cube Grey, Kablo Kesiti 1,5 - 10 mm ²	1,75 €	10
FTG-MC 00001 N	Mini Clic Cube Blue, Kablo Kesiti 1,5 - 10 mm ²	1,75 €	10
FTG-MC 00001 PE	Mini Clic Cube Green, Kablo Kesiti 1,5 - 10 mm ²	1,75 €	10
FTG-MC 00001 R	Mini Clic Cube Red, Kablo Kesiti 1,5 - 10 mm ²	1,75 €	10

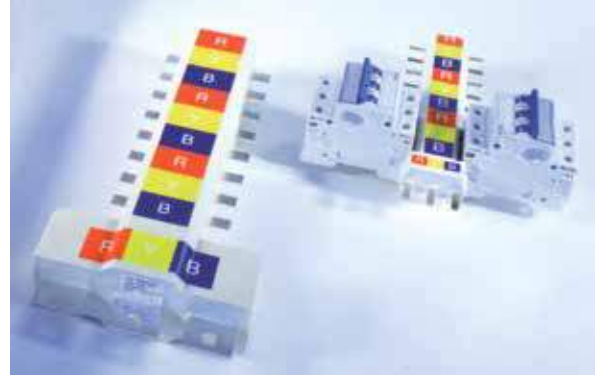
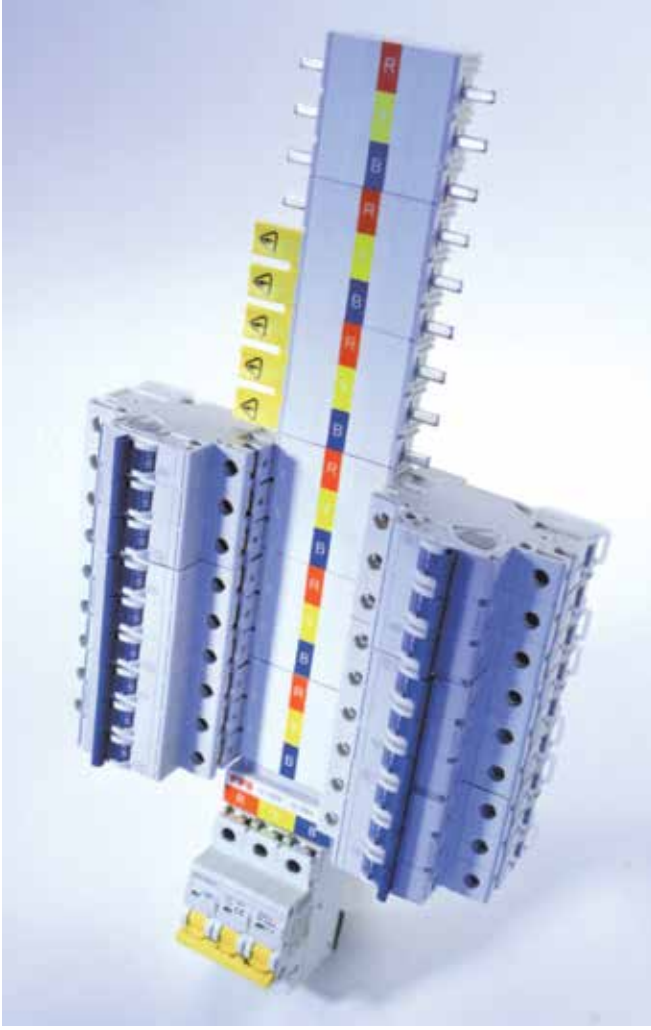

HAVA YALITIMLI BUSBARLAR



KOD	cinsi	AD. / €	K. / AD.
FTG-A106M3P18P00-01	125 A, 6 Yollu Hava Yalıtımlı Busbar	55,63 €	10
FTG-A108M3P18P00-01	125 A, 8 Yollu Hava Yalıtımlı Busbar	76,88 €	10
FTG-A110M3P18P00-01	125 A, 10 Yollu Hava Yalıtımlı Busbar	90,63 €	4
FTG-A206M3P18P00-01	250 A, 6 Yollu Hava Yalıtımlı Busbar	75,63 €	10
FTG-A208M3P18P00-01	250 A, 8 Yollu Hava Yalıtımlı Busbar	98,75 €	10
FTG-A210M3P18P00-01	250 A, 10 Yollu Hava Yalıtımlı Busbar	123,13 €	10
FTG-BRL5	Boşta Kalan Bağlantı Noktaları İçin Koruyucu Kapak	2,00 €	10

Not: 12 ... 24 yollu hava yalıtımlı busbar alternatifleri bulunmaktadır. Ⓢ

REÇİNELİ BUSBARLAR



KOD	cinsi	AD. / €	K. / AD.
FTG-B106M3P18P00-01	125 A, 6 Yollu Reçineli Busbar	143,75 €	10
FTG-B108M3P18P00-01	125 A, 8 Yollu Reçineli Busbar	170,63 €	10
FTG-B112M3P18P00-01	125 A, 10 Yollu Reçineli Busbar	195,00 €	10
FTG-B206M3L35P00-01	250 A, 6 Yollu Reçineli Busbar	231,00 €	1
FTG-B208M3L35P00-01	250 A, 8 Yollu Reçineli Busbar	249,00 €	1
FTG-B212M3L35P00-01	250 A, 10 Yollu Reçineli Busbar	296,88 €	1
FTG-BRL5	Boşta Kalan Bağlantı Noktaları İçin Koruyucu Kapak	2,00 €	10

Not: 12 ... 24 yollu Reçineli busbar alternatifleri bulunmaktadır. Ⓢ

Onka®



GÜÇ DAĞITIM BLOKLARI ve GÜÇ KLEMENSLERİ

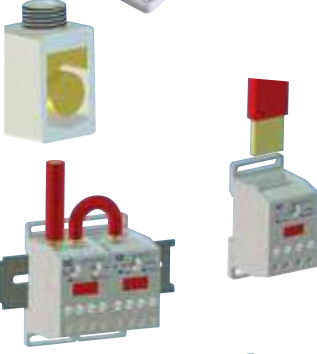

Renk Kodları

— Y	— B
— G	— YG
— R	— LG

KOD	CİNSİ	AD. / \$	K. / AD.
XK2-35 / 10 x 4	125 A, Giriş 35 mm ² - Çıkış : 4 x 10 mm ²	15,56 \$	20
XK2-35 / 4 x 9	125 A, Giriş 35 mm ² - Çıkış : 9 x 4 mm ²	16,80 \$	20
XK2-35 + 25 / 16 x 4	125 A, Giriş 2 x 35mm ² - Çıkış : 4x 16 mm ²	23,20 \$	12
XK2-50 / 10 x 6	150 A, Giriş 50 mm ² - Çıkış : 6 x 10 mm ²	19,60 \$	12
XK2-50 / 16 x 4	150 A, Giriş 50 mm ² - Çıkış : 4 x 16 mm ²	19,60 \$	12
XK2-70 / 6 x 12	192 A, Giriş 70 mm ² - Çıkış : 12 x 6 mm ²	27,32 \$	10
XK2-70 / 10 x 8	192 A, Giriş 70 mm ² - Çıkış : 8 x 10 mm ²	24,80 \$	10
XK2-70 x 2 / 10 x 8	192 A, Giriş 2 x 70 mm ² - Çıkış : 8 x 10 mm ²	29,40 \$	10
XK2-70 / 16 x 6	192 A, Giriş 70 mm ² - Çıkış : 6 x 16 mm ²	24,80 \$	10
XK2-95 / 25 x 4	232A, Giriş 95 mm ² - Çıkış : 4 x 25 mm ²	32,00 \$	10
XK2-120 / 16 x 8	232 A, Giriş 120 mm ² - Çıkış : 8 x 16 mm ²	47,36 \$	10
XK2-120B / 16 x 8	(Köprülenebilir) 232 A, Giriş 120 mm ² - Çıkış : 8 x 16 mm ²	47,36 \$	10
XK2-185/35 x 8	353 A, Giriş 185 mm ² - Çıkış : 8 x 35 mm ²	92,00 \$	10
XK2-185B / 35 x 8	(Köprülenebilir) 353 A, Giriş 185 mm ² - Çıkış : 8 x 35 mm ²	92,00 \$	10
XK2-185 x 2 / 35 x 8	353 A, Giriş 2 x 185 mm ² - Çıkış : 8 x 35 mm ²	Ⓢ	10
XK2-300 / 50 x 6	630 A, Giriş 300 mm ² - Çıkış : 6 x 50 mm ²	Ⓢ	10



XK2S-25/10x2+4x2	100 A, 25 mm ² Düz pin, Çıkış : 2 x 4 mm ² , 2 x 10 mm ²	9,24 \$	40
XK2S-35/10x2+4x2	125 A, 35 mm ² M6 delikli pin, Çıkış : 2 x 4 mm ² , 2 x 10 mm ²	9,24 \$	40
XK2S-25 / 4 x 9	100 A, 25 mm ² Düz pin, Çıkış : 9 x 4 mm ²	10,52 \$	40
XK2S-35 / 4 x 9	125 A, 35 mm ² M6 delikli pin, Çıkış : 9 x 4 mm ²	10,52 \$	40
XK2 HF-35 / 4 x 9	125 A, 35 mm ² ,Çatal Uçlu, M6 delikli pin, Çıkış : 9 x 4 mm ²	10,52 \$	40
XK2S-70 / 16 x 4	192 A, 70 mm ² M8 delikli pin, Çıkış : 4 x 16 mm ²	12,60 \$	25
XK2S-70 / 10 x 6	192 A, 70 mm ² M8 delikli pin, Çıkış : 6 x 10 mm ²	13,20 \$	25
XK2S-95 / 6 x 12	232 A, 95 mm ² M10 delikli pin, Çıkış : 12 x 6 mm ²	Ⓢ	20
XK2S-95 / 10x8	232 A, 95 mm ² M10 delikli pin, Çıkış : 8 x 10 mm ²	Ⓢ	20
XK2S-95 / 16 x 6	232 A, 95mm ² M10 delikli pin, Çıkış : 6 x 16 mm ²	Ⓢ	20
XK2S-95 / 25 x 4	232 A, 95 mm ² M10 delikli pin, Çıkış : 4 x 25 mm ²	Ⓢ	20
XK2S-120 / 16 x 8	269 A, 120 mm ² M12 delikli pin, Çıkış : 8 x 16 mm ²	Ⓢ	15
XK2S-120 / 35 x 4	269 A, 120 mm ² M12 delikli pin, Çıkış : 4 x 35 mm ²	Ⓢ	15

GÜÇ DAĞITIM BLOKLARI



KOD	CİNSİ	AD./ \$	K. / AD.
ONK80	80 A Giriş: 3 x 6 - 16 mm ² Çıkış: 4 x 2,5 - 6 mm ² 3 x 2,5 - 16 mm ²	6,00 \$	1



KOD	CİNSİ	AD./ \$	K. / AD.
ONK125	125 A Giriş: 1 x 10 - 35 mm ² 1 x 2,5 - 16 mm ² Çıkış: 6 x 2,5 - 16 mm ²	12,10 \$	1



KOD	CİNSİ	AD./ \$	K. / AD.
ONK160	160 A Giriş: 1 x 10 - 70 mm ² 1 x 2,5 - 16 mm ² Çıkış: 6 x 2,5 - 16 mm ²	12,60 \$	1

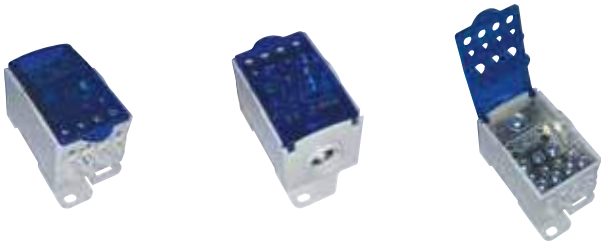

KOD	CİNSİ	AD./ \$	K. / AD.
ONK250	250 A Giriş: 1 x 35 - 120 mm ² Çıkış: 2 x 6 - 35 mm ² 5 x 2,5 - 16 mm ² 4 x 2,5 - 10 mm ²	31,25 \$	1



KOD	CİNSİ	AD./ \$	K. / AD.
ONK400	400 A Giriş: 1 x 95 - 185 mm ² Çıkış: 2 x 6 - 35 mm ² 5 x 2,5 - 16 mm ² 4 x 2,5 - 10 mm ²	32,55 \$	1



KOD	CİNSİ	AD./ \$	K. / AD.
ONK500	500 A Bara Giriş: 9,3 x 26,4 mm Çıkış: 2 x 6 - 35 mm ² 5 x 2,5 - 16 mm ² 4 x 2,5 - 10 mm ²	34,25 \$	1

Onka®



ÇİFT TARAF SAPLAMALI

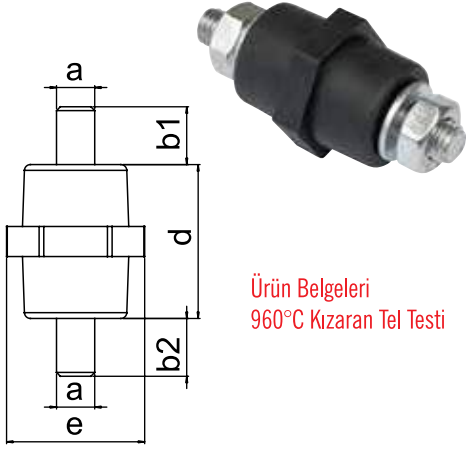

Ürün Belgeleri
960°C Kızaran Tel Testi

KOD	TİP	ÖLÇÜLER					SERVİS V	TEST V	TENSİLE	KG	AD./ç	K. AD.
		a	b1	b2	e	d						
İRMP51001	1N0-S/M5	5	12	12	18	25,5	0,6	3	1,00	8,50	3,04	500
İRMP51002	1N1-S/M6	6	16	16	21	29,5	0,6	3	1,00	8,70	4,59	300
İRMP51003	1NMS-1/M8	8	15	15	31,5	40	1	3	4,00	7,10	7,76	100
İRMP51004	1NMS-2/M10	10	15	15	31,5	40	1	3	4,00	9,50	8,18	100
İRMP51013	1NMS-3/M8	8	18	18	43,3	50	1	3	4,00	9,50	15,23	100
İRMP51014	1NMS-4/M10	10	18	18	43,3	50	1	3	4,00	9,50	16,53	100

SAPLAMA & KÖR SOMUNLU

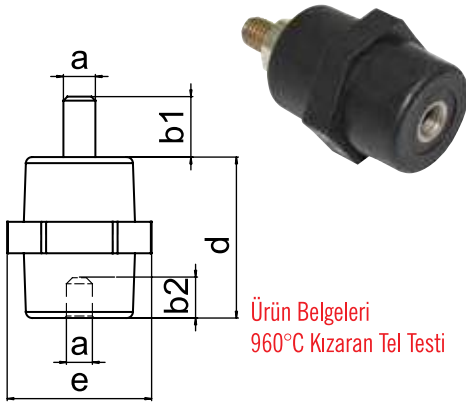

Ürün Belgeleri
960°C Kızaran Tel Testi

KOD	TİP	ÖLÇÜLER					SERVİS V	TEST V	TENSİLE	KG	AD./ç	K. AD.
		a	b1	b2	e	d						
İRMP51005	1N0-K/M5	5	12	9	18	25,5	0,6	3	1,00	8,50	2,65	500
İRMP51006	1N1-K/M6	6	16	12	21	29,5	0,6	3	1,00	7,50	5,20	300
İRMP51007	1NMK-3/M8	8	15,5	15	31,5	40	1	3	4,00	5,80	8,71	100
İRMP51008	1NMK2/M10	10	15	15	31,5	40	1	3	4,00	7,70	9,93	100
İRMP51015	1NMK-5/M8	8	18	15	43,3	50	1	3	4,00	7,70	15,95	100
İRMP51016	1NMK-6/M10	10	18	15	43,3	50	1	3	4,00	7,70	16,97	100

ÇİFT TARAF KÖR SOMUNLU

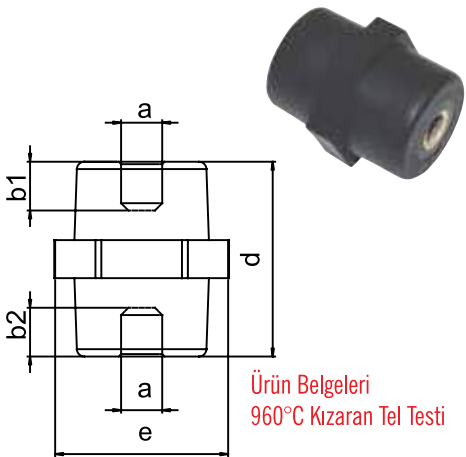

Ürün Belgeleri
960°C Kızaran Tel Testi

KOD	TİP	ÖLÇÜLER					SERVİS V	TEST V	TENSİLE	KG	AD./ç	K. AD.
		a	b1	b2	e	d						
İRMP51009	1N0-KK/M5	5	9	9	18	25,5	0,6	3	1,00	7,50	4,73	500
İRMP51010	1N1-KK/M6	6	12	21	21	29,5	0,6	3	1,00	6,30	6,11	300
İRMP51011	1NMK-4/M8	8	15	15	31,5	40	1	3	4,00	5,00	8,71	100
İRMP51012	1NMK-1/M10	10	15	15	31,5	40	1	3	4,00	5,00	9,93	100
İRMP51017	1NMK-7/M8	8	15	15	43,3	50	1	3	4,00	5,00	15,95	100
İRMP51018	1NMK-8/M10	10	15	15	43,3	50	1	3	4,00	5,00	16,97	100

PLASTİK (V0) TARAK İZOLATÖRLERİ



Ürün Belgeleri
50kA Tip Testi
960°C Kızaran Tel Testi

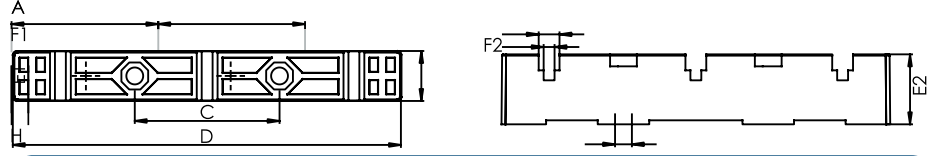

3x1F TARAK İZOLATÖR

KOD	TİP	ÖLÇÜLER								MIN	AD./ç	K. AD.
		A	C	D	E1	E2	F1	F2	H			
İRTPS1001	3X1F/5-10 mm	74	73	196	25	34,5	10,5	5,5	Ø8,5	5	21,60	50

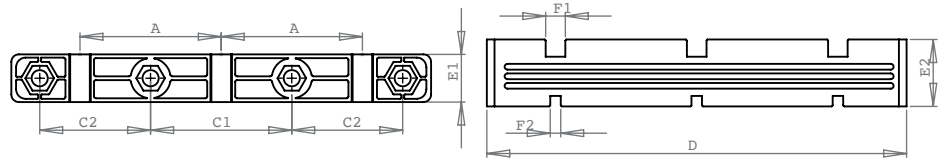

3x1F TARAK İZOLATÖR (4 TİJ)

KOD	TİP	ÖLÇÜLER								MIN	AD./ç	K. AD.	
		A	C1	C2	D	E1	E2	F1	F2				H
İRTPS1015	3X1F/5-10 mm	74	74	58,14	220	25	35	10,5	5,5	Ø8,5	5	22,50	50

YENİ

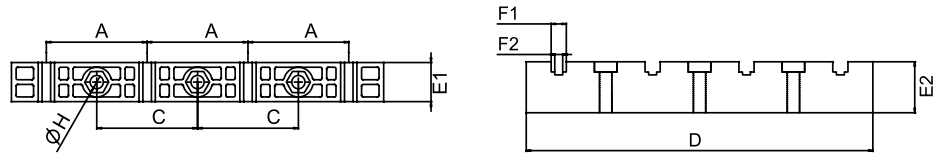

3x1F + N TARAK İZOLATÖR

KOD	TİP	ÖLÇÜLER								MIN	AD./ç	K. AD.
		A	C	D	E1	E2	F1	F2	H			
İRTPS1003	3X1F+N/5-10 mm	65	65	240	25,5	35,0	10,5	5,5	Ø9	5	26,88	50



Ürün Belgeleri
50kA Tip Testi
960°C Kızaran Tel Testi

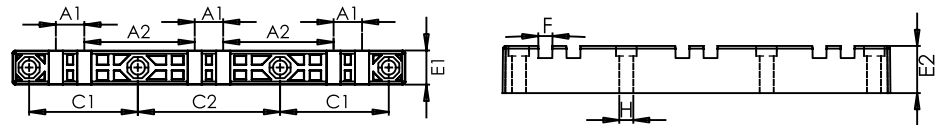

3x2F + N TARAK İZOLATÖR

KOD	TİP	ÖLÇÜLER								MIN	AD./ç	K. AD.	
		A1	A2	C1	C2	D	E1	E2	F1				H
İRTPS1002	3X2F/10 mm	20,5	81,3	80	105	290	25,0	34,5	10,5	Ø8,5	5	34,40	50



Ürün Belgeleri
65kA Tip Testi
960°C Kızaran Tel Testi

Tüm Ürünler 960°C Kızaran Tel Testi ile Belgelendirilmiştir.

PLASTİK (V0) TARAK İZOLATÖRLERİ

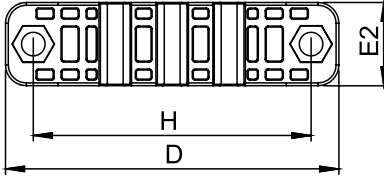
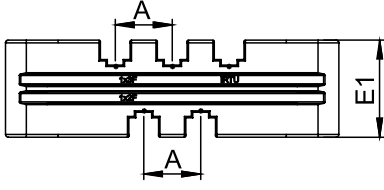

Ürün Belgeleri
960°C Kızaran Tel Testi

1X2F-1X3F 5-10 mm TARAK İZOLATÖR

KOD	TİP	ÖLÇÜLER					MIN	AD./ç	K. AD.
		A	D	H	E1	E2			
İRTPS1012	1x2F-1x3F/5-10 mm	20,5	120	100	35	30	5	21,60	100

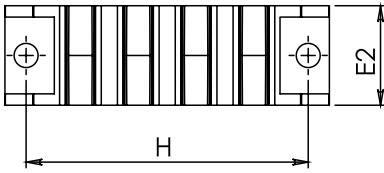
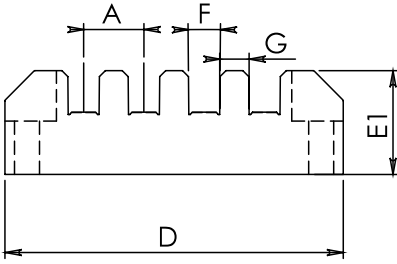

Ürün Belgeleri
960°C Kızaran Tel Testi

1X4F-10 mm TARAK İZOLATÖR (ALTI DÜZ TİP)

KOD	TİP	ÖLÇÜLER							MIN	AD./ç	K. AD.
		A	D	F	H	E1	E2	G			
İRTPS1009	1x4F/10 mm	20,5	115,0	10,5	100,0	35,0	35,00	10,00	5	29,12	80

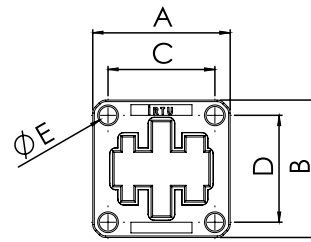
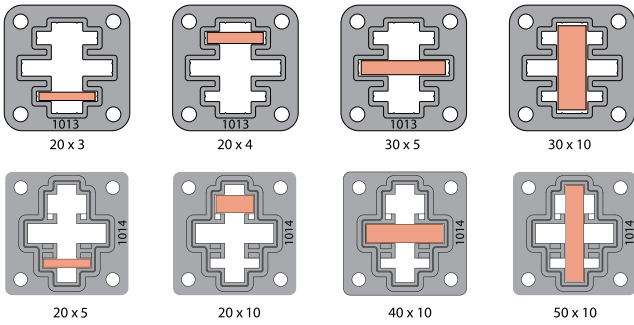

Ürün Belgeleri
960°C Kızaran Tel Testi



Bushings Properties

Bushings Material:	Glass Reinforced Polyamide 6.6
Conductor Temp:	140°C†
Flamability:	UL94-V0
Equipment Voltage U_e :	690V
Insulation Voltage U_i :	690V
Impulse Voltage U_{imp} :	8kV
Glow Wire:	960°C

GEÇİŞ İZOLATÖR

KOD	TİP	ÖLÇÜLER					MIN	AD./ç	K. AD.
		A	D	C	D	E			
İRTPS1013	GEÇİŞ İZOLATÖRÜ 20x3 / 20x4 / 30x5 / 30x10	45,0	45,0	35,0	35,0	5,80	5	11,52	100
İRTPS1014	GEÇİŞ İZOLATÖRÜ 25x5 / 20x10 / 40x10 / 50x10	60,00	60,00	45,00	45,00	6,50	5	14,40	100

PROFİL BAĞLANTILI PLASTİK (V0) TARAK İZOLATÖRLERİ



Ürün Belgeleri
960°C Kızaran Tel Testi

1x3F 5 mm TARAK İZOLATÖR

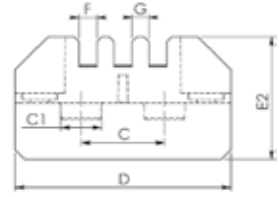
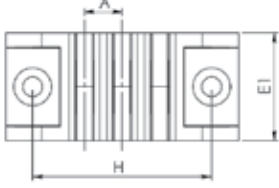

KOD	TİP	ÖLÇÜLER										MIN	AD./ç	K. AD.
		A	C	C1	D	F	H	E1	E2	G				
İRTPS1011	1X3F/5 mm	10,5	25,0	8X12,4	65,0	5,5	50,0	30,0	37,0	5,0	5	10,08	100	

KOD	TİP	KULLANILAN İZOLATÖR ADEDİ	KULLANILAN SAÇ PROFİL UZUNLUĞU	AD./ç	K. AD.
İRTPS1311	1X3F/5 mm 3 Faz Takım	6	430 mm	285	1
İRTPS1411	1X3F/5 mm 3 Faz +N Takım	8	600 mm	350	1



Ürün Belgeleri
65kA Tip Testi
960°C Kızaran Tel Testi

1x4F 5 mm TARAK İZOLATÖR

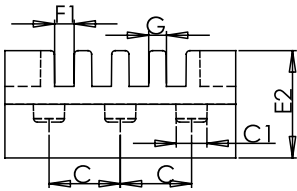
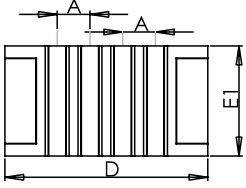

KOD	TİP	ÖLÇÜLER									MIN	AD./ç	K. AD.
		A	C	C1	D	F1	E1	E2	G				
İRTPS1005	1X4F/5 mm	10,5	20,0	8,0	65,0	5,5	35,0	30,0	5,0	5	11,44	100	

KOD	TİP	KULLANILAN İZOLATÖR ADEDİ	KULLANILAN SAÇ PROFİL UZUNLUĞU	AD./ç	K. AD.
İRTPS1305	1X4F/5 mm 3 Faz Takım	6	430 mm	285,00	1
İRTPS1405	1X4F/5 mm 3 Faz +N Takım	8	600 mm	350,00	1



Ürün Belgeleri
960°C Kızaran Tel Testi

1x2F 10 mm TARAK İZOLATÖR

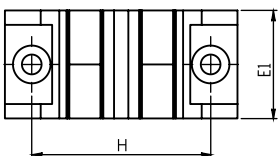
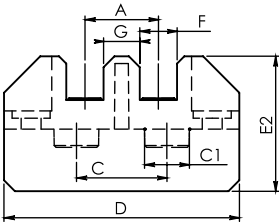

KOD	TİP	ÖLÇÜLER									MIN	AD./ç	K. AD.
		A	C	C1	D	F	H	E1	E2	G			
İRTPS1007	1X2F/10 mm	20,5	25,0	8X12,4	65,0	10,5	50,0	30,0	37,0	10,0	5	12,00	100

KOD	TİP	KULLANILAN İZOLATÖR ADEDİ	KULLANILAN SAÇ PROFİL UZUNLUĞU	AD./ç	K. AD.
İRTPS1307	1X2F/10 mm 3 Faz Takım	6	430 mm	285,00	1
İRTPS1407	1X2F/10 mm 3 Faz +N Takım	8	600 mm	350,00	1

PROFİL BAĞLANTILI PLASTİK (VO) TARAK İZOLATÖRLERİ

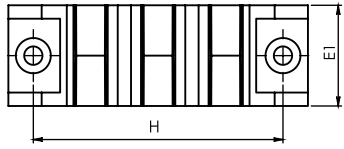
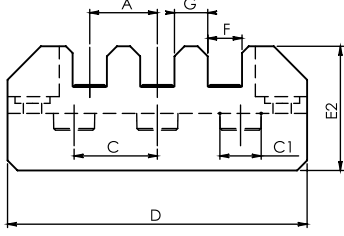

Ürün Belgeleri
960°C Kızaran Tel Testi

1x3F 10 mm TARAK İZOLATÖR

KOD	TİP	ÖLÇÜLER									MIN	AD./t	K. AD.
		A	C	C1	D	F	H	E1	E2	G			
İRTPS1008	1X3F/10 mm	20,5	20,0	8X12,4	90,0	10,5	75,0	30,0	37,0	10,0	5	17,12	100

KOD	TİP	KULLANILAN İZOLATÖR ADEDİ	KULLANILAN SAÇ PROFİL UZUNLUĞU	AD./t	K. AD.
İRTPS1308	1X3F/10 mm 3 Faz Takım	6	575 mm	330,00	1
İRTPS1408	1X3F/10 mm 3 Faz +N Takım	8	675 mm	380,00	1



Ürün Belgeleri
80kA Tip Testi
960°C Kızaran Tel Test

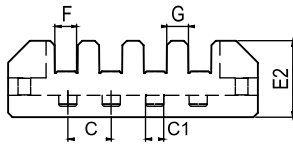
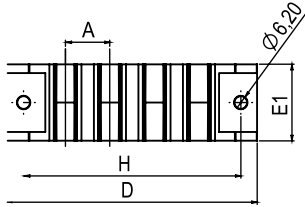

1x4F 10 mm TARAK İZOLATÖR

KOD	TİP	ÖLÇÜLER									MIN	AD./t	K. AD.
		A	C	C1	D	F	H	E1	E2	G			
İRTPS1006	1X4F/10 mm	20,5	20,0	8X12,4	115,0	10,5	100,0	35,0	35,0	10,0	5	21,28	100

KOD	TİP	KULLANILAN İZOLATÖR ADEDİ	KULLANILAN SAÇ PROFİL UZUNLUĞU	AD./t	K. AD.
İRTPS1306	1X4F/10 mm 3 Faz Takım	6	575 mm	330,00	1
İRTPS1406	1X4F/10 mm 3 Faz +N Takım	8	675 mm	380,00	1



Ürün Belgeleri
960°C Kızaran Tel Testi

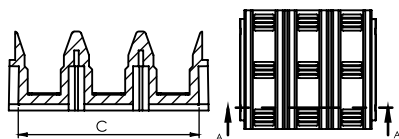
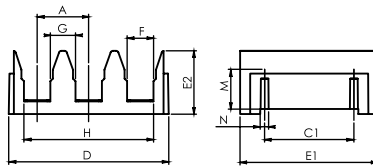

1x3F 10 mm TARAK İZOLATÖR

KOD	TİP	ÖLÇÜLER											MIN	AD./t	K. AD.
		A	D	F	H	E1	E2	G	C	C1	N	M			
İRTPS1010	1X3F/10 mm	21,0	69,6	10,5	51,5	55,0	25,0	10,0	63,0	35,5	3,35	15,7	5	13,20	100

KOD	TİP	KULLANILAN İZOLATÖR ADEDİ	KULLANILAN SAÇ PROFİL UZUNLUĞU	AD./t	K. AD.
İRTPS1310	1X3F/10 mm 3 Faz Takım	6	575 mm	350,00	1
İRTPS1410	1X3F/10 mm 3 Faz +N Takım	8	675 mm	400,00	1

ÇİFT TARAF SAPLAMALI

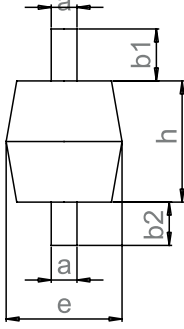

KOD	TİP	ÖLÇÜLER					Service	Test	Tensile	Ağırlık kg	AD./t	K. AD.
		a1	b1	b2	e	h						
İRMP1001	1N0-S/M5	5	12	12	22	24	0,6	3	0,75	11,00	2,38	500
İRMP1002	1N1-S/M6	6	15	15	27	28	0,6	3	1,00	12,00	3,38	300
İRMP1003	1NMS-1/M8	8	16	19	40	40	1	3	2,50	10,50	5,33	100
İRMP1004	1NMS-2/M10	10	12	15	40	40	1	3	2,70	14,00	5,46	100

SAPLAMA & KÖR SOMUNLU

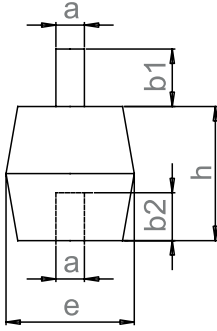

KOD	TİP	ÖLÇÜLER					Service	Test	Tensile	Ağırlık kg	AD./t	K. AD.
		a1	b1	b2	e	h						
İRMP1005	1N0-K/M5	5	12	12	22	24	0,6	3	0,75	10,50	2,87	500
İRMP1006	1N1-K/M6	6	15	15	27	28	0,6	3	1,00	10,80	3,84	300
İRMP1007	1NMK-3/M8	8	16	15	40	40	1	3	2,50	9,80	6,44	100
İRMP1008	1NMK-2/M10	10	15	15	40	40	1	3	2,70	11,40	6,83	100

ÇİFT TARAF KÖR SOMUNLU

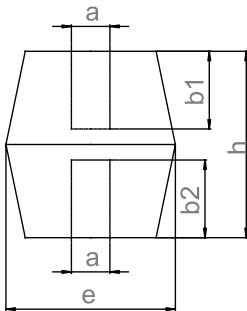

KOD	TİP	ÖLÇÜLER					Service	Test	Tensile	Ağırlık kg	AD./t	K. AD.
		a1	b1	b2	e	h						
İRMP1009	1N0-KK/M5	5	9	9	22	24	0,6	3	0,75	10,00	3,78	500
İRMP1010	1N1-KK/M6	6	12	12	27	28	0,6	3	1,00	9,90	5,04	300
İRMP1011	1NMK-4/M8	8	15	15	40	40	1	3	2,50	8,80	6,93	100
İRMP1012	1NMK-1/M10	10	15	15	40	40	1	3	2,70	8,90	7,35	100

ÇİFT TARAF KÖR SOMUNLU

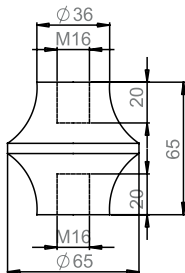

KOD	TİP	Service	Test	Tensile	Ağırlık kg	AD./t	K. AD.
İRMP1015	1NMC-3	3	15	5,00	4,60	25,35	18

ÇİFT TARAF KÖR SOMUNLU

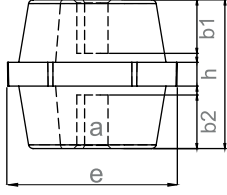

KOD	TİP	ÖLÇÜLER					Service	Test	Tensile	Ağırlık kg	AD./t	K. AD.
		a1	b1	b2	e	h						
İRMP1019	1NMK-5/M8	8	15	15	50	50	1	3	9	20,00	7,65	100
İRMP1020	1NMK-6/M10	10	15	15	50	50	1	3	9	21,00	9,60	100
İRMP1021	1NMK-7/M12	12	15	15	50	50	1	3	10	22,00	9,75	100

ÇİFT TARAF KÖR SOMUNLU

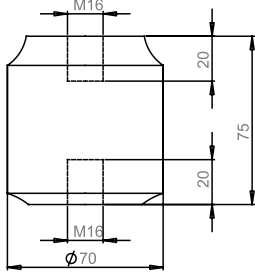

KOD	TİP	Service	Test	Tensile	Ağırlık kg	AD./t	K. AD.
İRMP1013	1NMD-1	3	20	6,00	9,00	25,88	18

ÇİFT TARAF KÖR SOMUNLU

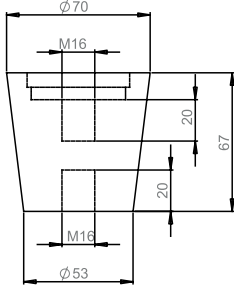

KOD	TİP	Service	Test	Tensile	Ağırlık kg	AD./t	K. AD.
İRMP1014	1NMA-2	3	15	5,50	6,65	27,00	18

ÇİFT TARAF KÖR SOMUNLU

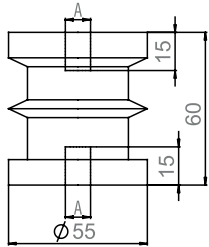

KOD	TİP	Service	Test	Tensile	Ağırlık kg	AD./t	K. AD.
İRMP1016	1N500	M8	3	15	5,00	14,76	32
İRMP1017	1N500	M10	3	15	5,00	14,94	32
İRMP1018	1N500	M12	3	15	5,00	15,30	32

Tüm Ürünler 960°C Kızaran Tel Testi ile Belgelendirilmiştir.

DAHİLİ TİP A.G. TARAK İZOLATÖR (Polyester)

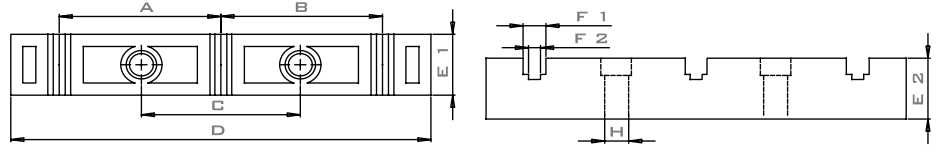

3x1F TARAK İZOLATÖR

KOD	TİP	ÖLÇÜLER									Min kN	AD./ t	K. AD.
		A	B	C	D	E1	E2	F1	F2	H			
İRTPL1002	3x1F/5-10 mm	74,5	74,5	73	193	30	30	10,5	5,5	Ø11	5	11,52	40

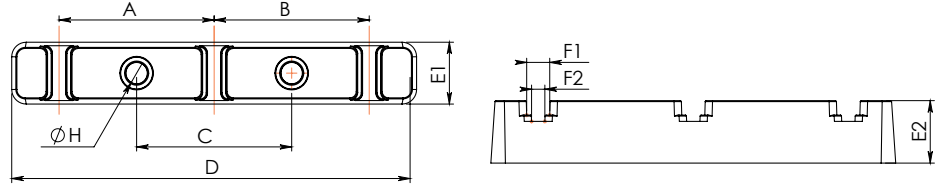

3x1F TARAK İZOLATÖR

KOD	TİP	ÖLÇÜLER									Min kN	AD./ t	K. AD.
		A	B	C	D	E1	E2	F1	F2	H			
İRTPL1012	3x1F/5-10 mm	74	74	74	193	30	30	6	11	Ø9,5	5	7,84	40

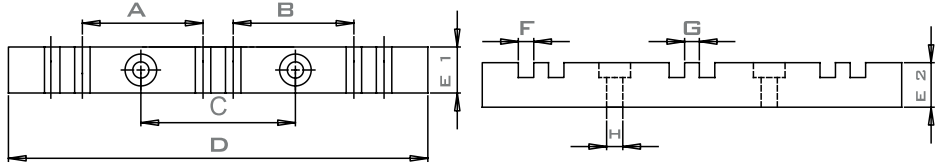

3x2F TARAK İZOLATÖR

KOD	TİP	ÖLÇÜLER									Min kN	AD./ t	K. AD.
		A	B	C	D	E1	E2	F1	F2	H			
İRTPL1007	3x2F/10 mm	82	82	105	285	31	30	10,5	10	Ø11	5	13,50	50
İRTPL1008	3x2F/5 mm	91,5	91,5	105	285	31	30	5,5	5	Ø11	5	13,50	50

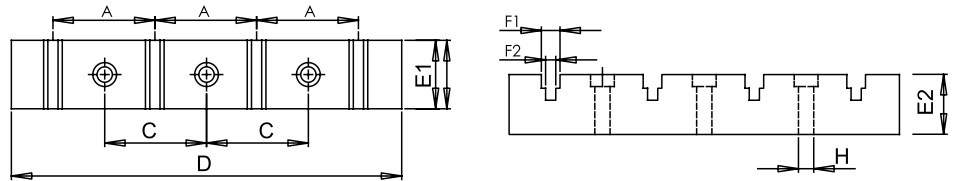

3x1F + N TARAK İZOLATÖR

KOD	TİP	ÖLÇÜLER									Min kN	AD./ t	K. AD.
		A	B	C	D	E1	E2	F1	F2	H			
İRTPL1005	3x1F+N/5-10 mm	60	60	230	40	34,5	10,5	5,5	Ø9	5	5	17,04	32

Tüm Ürünler 960°C Kızaran Tel Testi ile Belgelendirilmiştir.

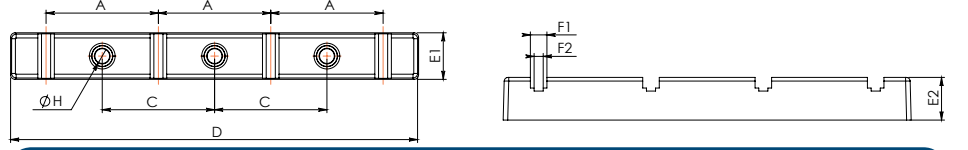

3x1F+N TARAK İZOLATÖR



KOD	TİP	ÖLÇÜLER										Min kN	AD./t	K. AD.
		A	B	C	D	E1	E2	F1	F2	H				
İRTPL1013	3x1F+N/5-10 mm	74	74	269	30	28	11	6	Ø9,5	5	5	12,68	50	

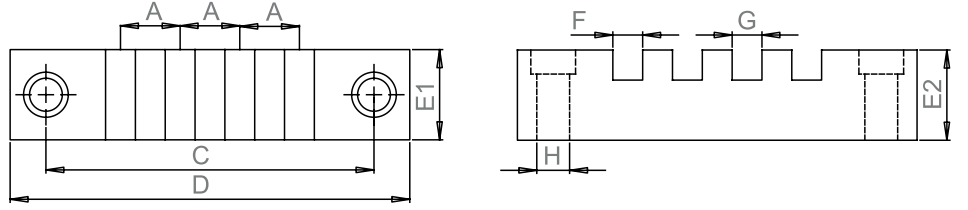

1x4F TARAK İZOLATÖR



KOD	TİP	ÖLÇÜLER										Min kN	AD./t	K. AD.
		A	B	C	D	E1	E2	F1	F2	H				
İRTPL1004	1x4F/5 mm	22	110	134	31	29	5,5	10,5	Ø9	5	5	9,00	50	
İRTPL1001	1x4F/10 mm	22	110	134	31	29	10,5	10,5	Ø9	5	5	9,00	50	

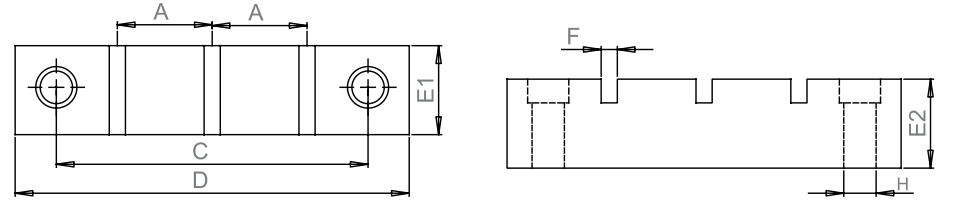

3x1FK TARAK İZOLATÖR



KOD	TİP	ÖLÇÜLER										Min kN	AD./t	K. AD.
		A	B	C	D	E1	E2	F1	F2	H				
İRTPL1003	3x1FK/5 mm Bakır	33	110	134	31	29	5,5	27	Ø9	5	5	9,00	50	

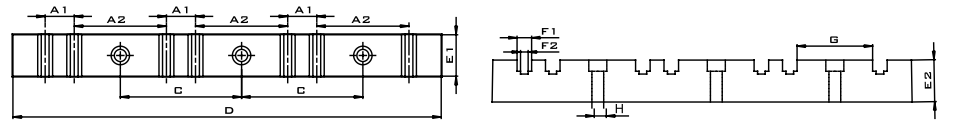

3x2F + N TARAK İZOLATÖR



KOD	TİP	ÖLÇÜLER										Min kN	AD./t	K. AD.
		A	B	C	D	E1	E2	F1	F2	H				
İRTPL1009	3x2F+N/5-10 mm	20,5	65	85,5	303	31	30	10,5/ 5,5	54,5	Ø8,5	5	22,00	50	

Tüm Ürünler 960°C Kızaran Tel Testi ile Belgelendirilmiştir.

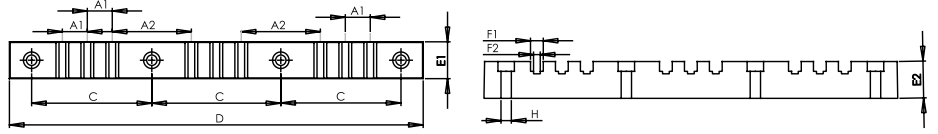

3x3 TARAK İZOLATÖR



KOD	TİP	ÖLÇÜLER											Min kN	AD./ t	K. AD.
		A1	A2	C1	C2	D	E1	E2	F1	F2	G	H			
İRTPL1010	3x3F/5-10 mm	20,5	65	98,75	106	340	30	30	10,5	5,5	10	Ø8,5	5	25,83	20

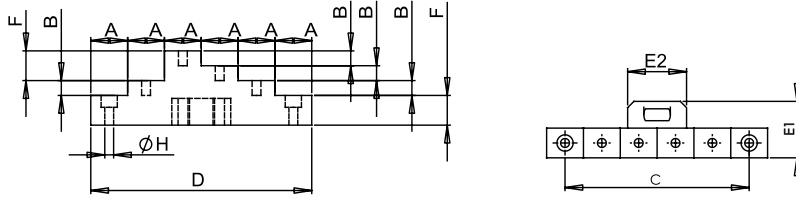

3x1FY+N TARAK İZOLATÖR



KOD	TİP	ÖLÇÜLER								Min kN	AD./ t	K. AD.
		A	B	C	D	E1	E2	F	H			
İRTPL1006	3x1FY + N	25	10	125	150	38	40	20	Ø6	5	18,53	26

BARA TUTUCU SERFİL



KOD	CİNSİ	FİYAT / t	K./AD.
EMTİ - M8-M10	SERFİL		100

EŞ POTANSİYEL BARA



KOD	CİNSİ	AD. / t	K./AD.
İR-303210	30 x 3 21 cm 5 Delik		1
İR-303250	30 x 3 25 cm 7 Delik		1
İR-303300	30 x 3 30 cm 10 Delik		1
İR-305210	30 x 5 21 cm 5 Delik		1
İR-305300	30 x 5 30 cm 7 Delik		1
İR-305400	30 x 5 40 cm 9 Delik		1
İR-305500	30 x 5 50 cm 12 Delik		1

Tüm Ürünler 960°C Kızaran Tel Testi ile Belgelendirilmiştir.

AG TRAF0 BUSHİNG İZOLATÖRLERİ



- * Yađlı tip dađıtım ve güç trafolarında bushing altı kullanılır.
- * Plastik malzemeden üretilmektedir.
- * Ekonomik çözümdür.



KOD	TİP	ÜRÜN TANIMI	AD. / ԉ	K. / AD.
İRBS-250	DT 250	250A AG Bushing İzolatör	4,10	100



İRBS-630	DT 630	630A AG Bushing İzolatör	8,00	100
-----------------	--------	--------------------------	-------------	-----



İRBS-1000	DT 1000	1000A AG Bushing İzolatör	24,05	100
------------------	---------	---------------------------	--------------	-----



İRBS-2000	DT 2000	2000A AG Bushing İzolatör	34,84	100
------------------	---------	---------------------------	--------------	-----



İRBS-3150	DT 3150	3150A AG Bushing İzolatör	40,17	100
------------------	---------	---------------------------	--------------	-----



İRBS-4500	DT 4500	4500A AG Bushing İzolatör	111,48	100
------------------	---------	---------------------------	---------------	-----

DAHİLİ TİP MESNET İZOLATÖRLER

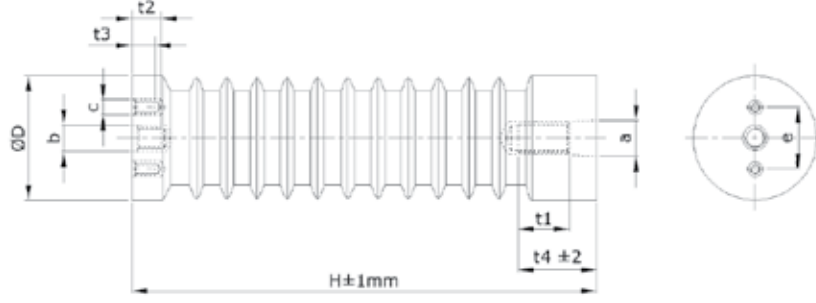

KOD	Um (kV)	ÜRÜN TANITIMI	ÜRÜN ADI	AD./t	K. AD.
İRM1002	12	10 N 500	12 kV DAHİLİ TİP MESNET İZOLATÖRÜ	⌚	25
İRM1003		10 N 1000	12 kV DAHİLİ TİP MESNET İZOLATÖRÜ	⌚	12
İRM2001	24	20 N 500	24 kV DAHİLİ TİP MESNET İZOLATÖRÜ	⌚	8
İRM2002		20 N 1000	24 kV DAHİLİ TİP MESNET İZOLATÖRÜ	⌚	8
İRM3001	36	30 N 500	36 kV DAHİLİ TİP MESNET İZOLATÖRÜ	⌚	6
İRM3002		30 N 1000	36 kV DAHİLİ TİP MESNET İZOLATÖRÜ	⌚	6

TİP		UM	MİN. BUKME	ÖLÇÜLER										MİN. KREPAJ	PERDE
IEC	VDE	Kv	N	H	e	D	a	b	c	t1	t2	t3	t4	mm	
J04-75	10N 500	12	4000	130	36	62	M16	M12	M6	24	15	14	36	160	5
J08-75	10N 1000	12	8000	130	46	80	M20	M16	M10	27	33	15	42	187	5
J04-125	20N 500	24	4000	210	36	74	M16	M12	M6	33	15	14	50	320	8
J08-125	20N 1000	24	8000	210	46	86	M20	M16	M10	27	33	15	44	320	8
J04-170	30N 500	36	4000	300	36	76	M16	M12	M6	33	15	14	54	445	11
J10-170	30N 1000	36	10000	300	46	99	M24	M16	M10	36	33	15	60	445	11

DAHİLİ TİP ORTA GERİLİM KAPASİTİP GERİLİM MESNET İZOLATÖRLER

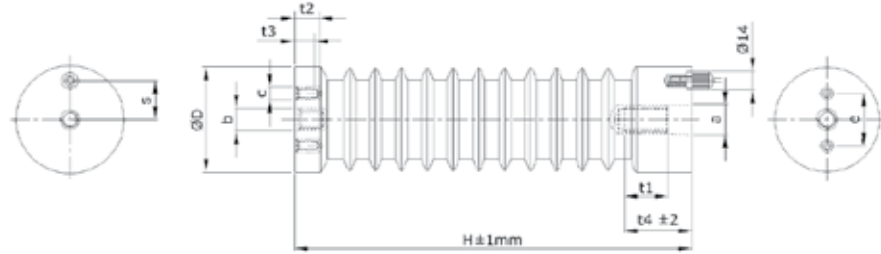

KOD	Um (kV)	ÜRÜN ADI	AD./t	K. AD.
İRDG1201	12	10 N 1000-K CZ (J08-75)	⌚	12
İRDG2401	24	20 N 500	⌚	8
İRDG2401		20 N 1000-K CZ1 (J08-125)	⌚	8
İRDG3601	36	30 N 500-K (J04-170)	⌚	6
İRDG3602		30 N 1000-K (J10-170)	⌚	3

TİP	UM	MİN. BUKME	ÖLÇÜLER										MİN. KREPAJ	PERDE	
	Kv	N	H	e	D	s	a	b	c	t1	t2	t3	t4		mm
10N 100	12	8000	130	46	80	30	M20	M16	M10	17	20	17	20	160	5
20N 500	24	4000	210	36	74	30	M20	M12	M6	35	20	14	47	320	8
20N 1000	24	8000	210	46	86	30	M16	M16	M10	35	27	20	47	320	8
30N 500	36	4000	300	36	82	34	M24	M12	M6	19	22	17	50	435	11
30N 1000	36	8000	300	36	82	34	M24	M16	M10	36	21	17	57	435	11

ASKI APARATI



KOD	AÇIKLAMA	AD. / ʈ	K. AD.
İR-7001	80'lik Kablo Taşıma Askısı	17,40	50

SIEMENS KÖRÜK



KOD	AÇIKLAMA	AD. / ʈ	K. AD.
İRPKT-1050	Gırtlaklı Körük / 180 x 64 Siemens	9,00	60

* Orta gerilim hücre içinde kablo girişlerinde sızdırmalara karşı kullanılır.

ORTA GERİLİM HÜCRE KABLO KÖRÜĞÜ



KOD	AÇIKLAMA	AD. / ʈ	K. AD.
İRPKT-1040	Ø100 Plastik Kablo Tutucu	7,45	100
İRPKT-1030	Ø66 Plastik Kablo Tutucu	9,40	120

ORTA GERİLİM HÜCRE KABLO TUTUCU



KOD	ÜRÜN TANIMI	AD. / ʈ	K. / AD.
İRPKT-1020	PLASTİK KABLO TUTUCU / PLASTIC CABLE BELLOWS	17,55	100



- * Orta gerilim hücre içinde kablo girişlerinde kullanılır.
- * Yanmaz ve halogen-free özelliğindedir.
- * Ø 50-80 mm kabloya uygundur.

TIRNAKLI KROŞELER (PLASTİK)

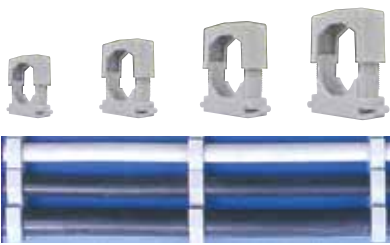

KOD	ÜRÜN TANIMI	AD. / ʈ	K. / AD.
İR-5155	No. 1 Tırnaklı Kroşe 2 x 1.5 / 2 x 2.5 / 2 x 4 / 2 x 6 / 3 x 1.5 / 4 x 1.5 / 3 x 2.5 / 4 x 2.5	1,29	100
İR-5156	No. 2 Tırnaklı Kroşe 4 x 4 / 4 x 6	1,62	100
İR-5157	No. 3 Tırnaklı Kroşe 4 x 10 NYM / 3 x 16 + 10 NYY	2,12	100
İR-5158	No. 4 Tırnaklı Kroşe 3 x 25 + 16 / 3 x 35 + 16 / 3 x 50 + 25 NYY	2,70	25

BORU / KABLO SABİTLEYİCİLER ve BAĞLANTI RAYLARI



KOD	ÜRÜN TANIMI	AD. / ʈ	K. / AD.
İR-9001	BORU VE KABLO SABİTLEYİCİSİ (8-36)	5,51	750
İR-9002	BORU VE KABLO SABİTLEYİCİSİ (14-48)	21,03	250
İR-9003	BORU VE KABLO SABİTLEYİCİSİ (24-72)	28,28	250

BORU / KABLO BAĞLANTI RAYLARI



KOD	ÜRÜN TANIMI	AD. / ʈ	K. / AD.
İRMR-9001	GALVANİZ RAY (8-36) (2 mt)	26,10	100
İRMR-9002	GALVANİZ RAY (14-48 / 24-72) (2 mt)	62,25	100



CAM ELYAF PLAKALAR



KOD	AÇIKLAMA	ÖLÇÜLER (mm)			AD./t
		Kalınlık	En	Boy	
İRCEP038001200	Cam Elyaf Polyester Plaka	3	800	1200	604,80
İRCEP058001200		5	800	1200	1.008,00
İRCEP108001200		10	800	1200	2.016,00
İRCEP158001000		15	800	1200	3.024,00
İRCEP208001200		20	800	1200	4.032,00
İRCEP258001000		25	800	1200	5.040,00
İRCEP308001000		30	800	1200	6.048,00
İRCET030301200	Cam Elyaf Polyester Takoz	3	30	1200	24,84
İRCET030401200		3	40	1200	33,12
İRCET030501200		3	50	1200	41,40
İRCET030601200		3	60	1200	49,68
İRCET050301200	Cam Elyaf Polyester Takoz	5	30	1200	37,80
İRCET050401200		5	40	1200	50,40
İRCET050501200		5	50	1200	63,00
İRCET050601200		5	60	1200	75,60
İRCET100301200	Cam Elyaf Polyester Takoz	10	30	1200	75,60
İRCET100401200		10	40	1200	100,80
İRCET100501200		10	50	1200	126,00
İRCET100601200		10	60	1200	151,20
İRCET150301200	Cam Elyaf Polyester Takoz	15	30	1200	113,40
İRCET150401200		15	40	1200	151,20
İRCET150501200		15	50	1200	189,00
İRCET150601200		15	60	1200	226,80
İRCET200301200	Cam Elyaf Polyester Takoz	20	30	1200	151,20
İRCET200401200		20	40	1200	201,60
İRCET200501200		20	50	1200	252,00
İRCET200601200		20	60	1200	302,40
İRCET250301200	Cam Elyaf Polyester Takoz	25	30	1200	189,00
İRCET250401200		25	40	1200	252,00
İRCET250501200		25	50	1200	315,00
İRCET250601200		25	60	1200	378,00
İRCET300301200	Cam Elyaf Polyester Takoz	30	30	1200	226,80
İRCET300401200		30	40	1200	302,40
İRCET300501200		30	50	1200	378,00
İRCET300601200		30	60	1200	453,60

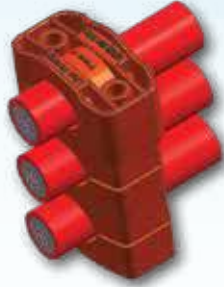

OG ANTİSTATİK KABLO KROŞESİ

MODEL	ÜRÜN AÇIKLAMASI	AD. / t
TİP-1P/1-2-3-4-5-6-7	XLPE Kablo Kroşesi - Polyamid - 36KV 1x35/16 mm ² 1x150/16 mm ² XLPE Kablo için Min Çap : 32 mm - Max Çap : 38 mm	☎
TİP-2P/1-2-3-4-5-6	XLPE Kablo Kroşesi - Polyamid - 36KV 1x150/16 mm ² 1x400/35 mm ² XLPE Kablo için Min Çap : 38 mm - Max Çap : 47 mm	☎
TİP-3P/1-2-3-4-5	XLPE Kablo Kroşesi - Polyamid - 36KV 1x500/35 mm ² 1x630/35 mm ² XLPE Kablo için Min Çap : 52 mm - Max Çap : 68 mm	☎
TİP-1HF/1-2-3-4-5-6-7	XLPE Kablo Kroşesi - Polyamid HF / UV - 36KV 1x35/16 mm ² 1x150/ 16 mm ² XLPE Kablo için Min Çap : 32 mm - Max Çap : 38 mm	☎
TİP-2HF/ 1-2-3-4-5-6-7	XLPE Kablo Kroşesi - Polyamid HF / UV - 36KV 1x150/16 mm ² 1x400/35 mm ² XLPE Kablo için Min Çap : 38 mm - Max Çap : 47 mm	☎
TİP-3HF/1-2-3-4-5	XLPE Kablo Kroşesi - Polyamid HF / UV - 36KV 1x500/35 mm ² 1x630/35 mm ² XLPE Kablo için Min Çap : 52 mm - Max Çap : 68 mm	☎

Birim fiyatlara civata ve somun dahildir. TEDAŞ / TEİAŞ standartlarına uygundur.





KONDANSATÖRÜN TEMEL YAPISI

1. FILM: Çok Katmanlı Metalize Polipropilen Film (MPP), çinkodan elde edilen filmden daha yüksek stabiliteye ve alüminyum filmden daha uzun raf ömrüne sahiptir. Daha yüksek akım taşıma kapasitesi sağlayan ve anahtarlama dalgalanmaları nedeniyle daha yüksek elektro-mekanik gerilime dayanabilen kenar, metal uç spreyle daha iyi yapıyı sağlar. Ayrıca MPP film kendi kendini iyileştirme özelliğine sahiptir.

2. SARGI: İşviçre'de Dünya standartlarında üretilen CNC makinelerinde tozsuz, sıcaklık ve nem kontrollü ortamda sarılmış temel kapasitör elemanı.

3. GÜVENLİK SİSTEMİ:

a) Patlamaya dayanıklı güvenlik cihazı; Aşırı basınç ayırıcısı, Kondansatörün içinde herhangi bir arıza oluşursa, kondansatörün iç basıncı artar, artan basınç körüğünün ve dolayısıyla üst kapağın genişlemesine neden olur. Bu sistem sayesinde kondansatörün patlamasını önlemek için aşırı basınç ayırıcısı ile elektrik devresi ayrılır.

b) Kendi kendini iyileştirme özelliği

Termik veya aşırı elektrik yükü durumunda, elektrik arızası meydana gelir. Arıza kanalındaki dielektrik, arıza kanalından patlayan ve dielektrik tabakalarını birbirinden uzaklaştıran yüksek derecede sıkıştırılmış plazmaya ayrılır. Deşarj alanında plazma tabakasının içinde metal tabakalar aracılığıyla deşarj devam eder, böylece hatalı alanın çevreindeki metal tamamen yanar. Bu, hatalı alanın mikrosaniye süre içinde mükemmel izolasyonunu sağlar. Kendi kendini iyileştirme süreci ihmal edilebilir kapasite kaybına yol açar. Bu kayıp olay başına 100 pF'den azdır. Kapasitör, tüm süreç boyunca tamamen işlevsel kalır.

c) Reçine: Üretimde yağ yada PCB yerine Poliüretan reçine dolgusu kullanılması nedeniyle, yağ sızmasının meydana getireceği yangın riski yoktur.

4. YAPI: 3 fazlı kapasitör oluşturmak için 3 katmanlı film alüminyum kasa içerisinde üçgen olarak bağlanır.

5. DEŞARJ DİRENCİ: Operatörün güvenliği için, önce kapasitörün boşaltılması önerilir. Tüm kondansatörler 50V'dan düşük gerilime 1 dakika içinde deşarj edilmesi için deşarj dirençleri ile donatılmıştır.

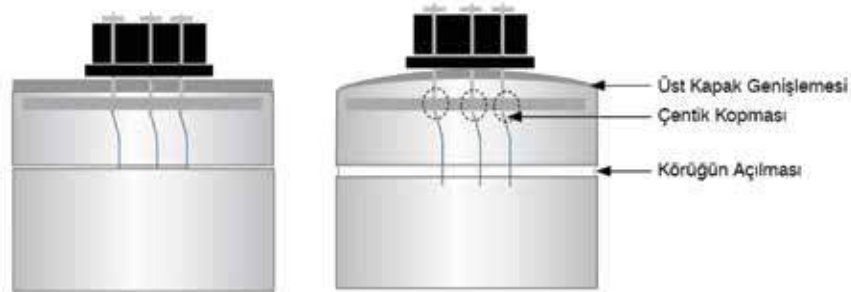

TEKNİK ÖZELLİKLER

Standart	IEC 60831-1 & 2 IS : 13340
Tip	MKP Silindirik
Güç Aralığı (230V)	0.25 - 10 kVAr Tek Ünite
Güç Aralığı (400-415V-440V)	0.25 - 50 kVAr Tek Ünite
Güç Aralığı (525V)	5 - 50 kVAr Tek Ünite
Güç Aralığı (690V)	5 - 50 kVAr Tek Ünite
Anma Gerilimi	230V-400V-415V-440V-525V-690V
Frekans	50 - 60 Hz
Maksimum Aşırı Gerilim U_{max}	Un + % 10 - 8 h /24 h Un + % 15 - 30 dk /24 h Un + % 20 - 5 dk /24 h Un + % 30 - 1 dk /24 h
Dielektrik	Kendini onarabilen metalize edilen Polipropilen Film
Aşırı Akım	2xIn
Direnç Hariç Kayıplar	<0.2 Watt/kVAr
Direnç Dahil Kayıplar	<0.3 Watt/kVAr
Koruma Sınıfı	IP20
Soğutma	Doğal Soğutma
Maksimum Yükseklik	2000 metre
Kasa	Alüminyum Kasa / Silindirik
Deşarj	Dahili deşarj dirençli 50 V altına 60 s'de düşer.
Terminal	16 mm ² Kesitine Uygun Ark Korumalı Çift ve Üç Yönlü Terminal
Uygulama	Dahili
Kullanım Ömrü	50 °C ≥ 150.000 Saat (C Sınıfı) 55 °C ≥ 130.000 Saat (D Sınıfı)
Darbe Akımı	(200 - 400)xI _r
Kapasite Toleransı	Alt yönde -%5 Üst yönde +%10
Test Gerilimi Terminal-Terminal	2,15xUn, 10 s (Tip Test için) 2,15xUn, 2 s (Rutin Test için)
Test Gerilim Kasa - Terminal	3 kV, 1 dk (Tip Test için) 3 kV, 10s, min 2s (Rutin Test için)
Ortalama Sıcaklığı	- 40 °C / + 55 °C (D Sınıfı)
Montaj Pozisyonu	Yatay veya Dikey Dikey kullanılması tavsiye edilir
Maksimum Nem	95%
Topraklama	M12 Civata ile
Koruma Özelliği	Aşırı basınçta açan kendini onarabilen
Emdirme	PCB içermeyen reçineli dolgu materyali

MONOFAZE (230V) 50Hz

MALZEME TANIMI	kVAr 230V 50Hz	ÖLÇÜLER (DxH mm)	AKIM (A)	KAPASİTANS (uF)	AD. / ʘ	K. AD.
Kondansatör , 230V	0,25	45*113	1,09	15,04	75,00	16
Kondansatör , 230V	0,5	45*113	2,18	30,08	75,00	16
Kondansatör , 230V	1	45*113	4,35	60,16	85,00	16
Kondansatör , 230V	1,5	50*140	6,53	90,25	105,00	16
Kondansatör , 230V	2,5	63.5*140	10,87	150,41	146,00	16
Kondansatör , 230V	5	63.5*248	21,74	300,82	286,00	16
Kondansatör , 230V	7,5	85*255	32,61	451,23	510,00	8
Kondansatör , 230V	10	85*330	43,48	601,64	650,00	8

ÜÇ FAZ (400V-415V-440V) 50 Hz

MALZEME TANIMI	kVAr 400V 50Hz	kVAr 415V 50Hz	kVAr 440V 50Hz	ÖLÇÜLER (DxH mm)	AKIM (A)	KAPASİTANS (uF)	AD. / ʘ	K. AD.
Kondansatör , 400-415-440V	0,5	0,54	0,61	50*175	0,72	4,97	93,00	16
Kondansatör , 400-415-440V	1	1,08	1,21	50*175	1,44	9,95	94,00	16
Kondansatör , 400-415-440V	1,5	1,61	1,82	50*175	2,17	14,92	108,00	16
Kondansatör , 400-415-440V	2,5	2,69	3,03	50*175	3,6	24,86	125,00	16
Kondansatör , 400-415-440V	5	5,38	6,05	63.5*200	7,22	49,73	172,00	16
Kondansatör , 400-415-440V	7,5	8,07	9,08	75*216	10,83	74,59	234,00	8
Kondansatör , 400-415-440V	10	10,76	12,10	75*257	14,43	99,46	260,00	8
Kondansatör , 400-415-440V	12,5	13,46	15,13	85*255	18,04	124,32	305,00	8
Kondansatör , 400-415-440V	15	16,15	18,15	85*255	21,65	149,19	364,00	8
Kondansatör , 400-415-440V	20	21,53	24,20	85*330	28,87	198,92	496,00	4
Kondansatör , 400-415-440V	25	26,91	30,25	90*330	36,08	248,65	570,00	4
Kondansatör , 400-415-440V	30	32,29	36,30	85*405	43,30	298,38	645,00	4
Kondansatör , 400-415-440V	40	43,06	48,40	100*405	57,74	397,84	1.070,00	4
Kondansatör , 400-415-440V	50	53,82	60,50	116*390	72,17	497,29	1.200,00	4

3 FAZ (525V) Hz





MALZEME TANIMI	kVAr 230V 50Hz	ÖLÇÜLER (DxH mm)	AKIM (A)	KAPASİTANS (uF)	AD. / ʘ	K. AD.
Kondansatör , 525V	12,5	85*255	13,75	72,17	400,00	8
Kondansatör , 525V	15	85*330	16,50	86,60	436,00	8
Kondansatör , 525V	20	90*330	22,00	115,47	550,00	4
Kondansatör , 525V	25	85*405	27,50	144,34	720,00	4
Kondansatör , 525V	30	100*405	33,00	173,21	765,00	4

HAWCON DAİMİ DEVRE MOTOR ve AYDINLATMA KONDANSATÖRLERİ

İTHALATIMIZ

HAWCON
KONDANSATÖR



KAPASİTE / μf CBB 60	Pls. Tüp Kablolu 400/450V AD. (\$) 	400/450V Ölçü (mm) Ebatları	Pls. Tüp Vidalı 250V AD. (\$) 
0,5		25 x 65	
1		25 x 65	
1,5		25 x 65	
2		25 x 65	
2,5		25 x 65	
3		25 x 65	
3,5		25 x 65	
4		25 x 65	
4,5		30 x 65	
5		30 x 63	
6		30 x 63	
6,5		30 x 63	
7		30 x 63	
7,5		30 x 63	
8		30 x 63	
9		30 x 63	
10		34 x 63	
12		34 x 71	
12,5		34 x 71	
14		34 x 71	
15		34 x 71	
16		34 x 71	
18		40 x 72	
20		40 x 72	
25		40 x 72	
30		44 x 72	
32		44 x 72	
35		44 x 72	
40		44 x 95	
45		44 x 95	
50		48 x 95	
55		48 x 102	
60		48 x 102	
65		48 x 102	
70		-	
80		-	
85		-	
100		58 x 123	

FAN KONDANSATÖRLERİ KARE TİP (400 - 450 V)

İTHALATIMIZ

HAWCON
KONDANSATÖR



KAPASİTE / μf CBB 61	Ölçü (mm) Ebatları	Birim Fiyat AD. (\$) 
0,5 - 1	36x11 x 22	
1,5	38x13,5 x 24	
2	38x15 x 25	
2,5	38x15 x 25	
3	38x15 x 25	
4	47x17 x 28	
5	47x20,5 x 33	
6	47x20,5 x 33	
8	48x22 x 35	
10	47x23 x 35	

HAWCON MOTOR İLK HAREKET (START) KONDANSATÖRLERİ

İTHALATIMIZ



KAPASİTE / μf	ÇAP (\emptyset)	VOLT	HAWCON AD. (\$)	ELKON AD. (\$)
43 - 53	36	220 - 250V	☎	☎
53 - 64	36	220 - 250V		
64 - 77	36	220 - 250V		
72 - 88	36	220 - 250V		
88 - 106	36 - 46	220 - 250V		
108 - 130	36 - 46	220 - 250V		
124 - 149	36 - 46	220 - 250V		
130 - 156	36 - 46	220 - 250V		
145 - 175	36 - 46	220 - 250V		
161 - 193	46	220 - 250V		
189 - 227	46	220 - 250V		
216 - 259	46	220 - 250V		
233 - 280	46	220 - 250V		
280 - 333	46	220 - 250V		

HAWCON DAİMİ DEVRE MOTOR KONDS. PLASTİK TÜP VİDALI, TERMİNALLI

İTHALATIMIZ



KAPASİTE / μf CBB 60	400/450V Ölçü (mm) Ebatları	Birim Fiyat AD. (\$)
2	30 x 57	☎
2,5	30 x 57	
3	30 x 57	
4	35 x 65	
5	35 x 65	
6	35 x 65	
8	35 x 65	
9	35 x 65	
10	35 x 65	
12,5	40 x 70	
15	40 x 70	
16	40 x 70	
18	40 x 70	
20	40 x 70	
25	45 x 95	
30	45 x 95	
35	50 x 106	
40	50 x 106	
45	50 x 106	
50	50 x 106	
60	50 x 106	
70	50 x 116	
80	60 x 120	
90	60 x 120	
100	60 x 120	

SEZGİN ALÇAK GERİLİM AKIM TRAFOLARI

Sezgin®

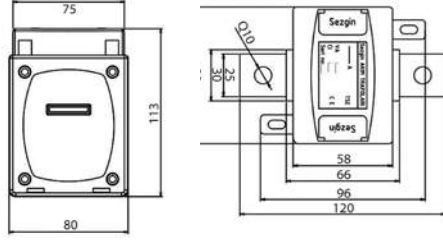

TO.B

ANMA AKIMI (A)	SINIF	GÜÇ (VA)	AD. / ƒ
5/5 - 10/5 - 15/5 - 20/5 - 25/5 - 30/5 - 40/5 - 50/5 - 60/5 - 75/5 - 80/5 - 100/5 - 125/5 - 150/5	0,5-01	5	☎
		10	
		15	
200/5 - 250/5 - 300/5 - 400/5 - 500/5 - 600/5	0,5-01	5	☎
		10	
		15	
MÜHÜRLÜ TİP			
5/5 - 10/5 - 15/5 - 20/5 - 25/5 - 30/5 - 40/5 - 50/5 - 60/5 - 75/5 - 80/5 - 100/5 - 125/5 - 150/5	0,5	10	☎

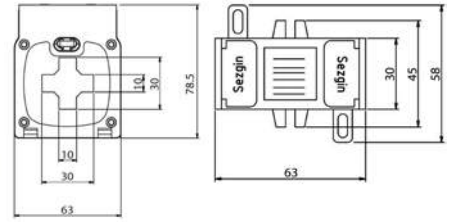

TO.30 M (RAYA MONTAJ)

ANMA AKIMI (A)	SINIF	GÜÇ (VA)	AD. / ƒ	
20/5 - 25/5 - 30/5 - 40/5 - 50/5 - 60/5 - 75/5 - 80/5 - 100/5 - 125/5 - 150/5	1	5	☎	
		100/5		1,25
		150/5 - 200/5		2,5
200/5 - 250/5 - 300/5 - 400/5 - 500/5 - 600/5	0,5	5	☎	
300/5 - 400/5 - 500/5 - 600/5	0,5	10		
Raya Montaj Aparatı				

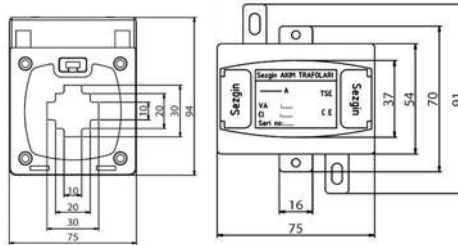

TO.30 D

ANMA AKIMI (A)	SINIF	GÜÇ (VA)	AD. / ƒ
200/5	0,5-01	5	☎
		10	
		15	
MÜHÜRLÜ TİP			
200/5	0,5	10	☎

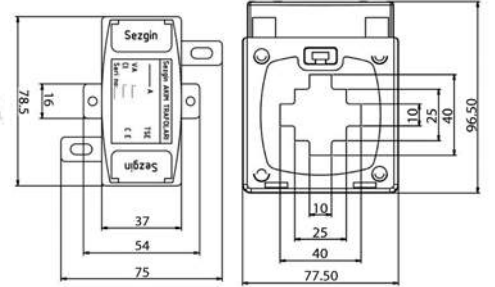

TO.40

ANMA AKIMI (A)	SINIF	GÜÇ (VA)	AD. / ƒ
400/5 - 500/5 - 600/5	0,5-01	5	☎
		10	
		15	
MÜHÜRLÜ TİP			
400/5 - 500/5 - 600/5	0,5	10	☎

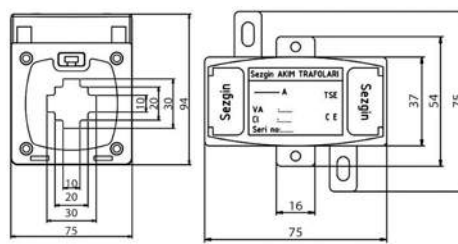

TO.30

ANMA AKIMI (A)	SINIF	GÜÇ (VA)	AD. / ƒ
250/5 - 300/5	0,5-01	5	☎
		10	
		15	
20/5 - 25/5 - 30/5 - 40/5 - 50/5 - 60/5 - 75/5 - 80/5 - 100/5 - 125/5 - 150/5	1	5	☎
		10	
		15	
MÜHÜRLÜ TİP			
250/5 - 300/5	0,5	10	☎

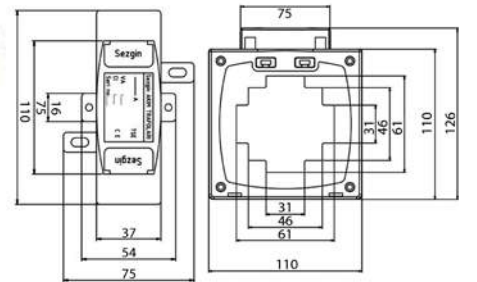

TO.60

ANMA AKIMI (A)	SINIF	GÜÇ (VA)	AD. / ƒ
700/5 - 750/5 - 800/5	0,5-01	5	☎
		10	
		15	
1000/5 - 1200/5 - 1250/5	0,5-01	5	☎
		10	
		15	
MÜHÜRLÜ TİP			
700/5 - 750/5 - 800/5	0,5	10	☎
1000/5 - 1200/5 - 1250/5	0,5	10	

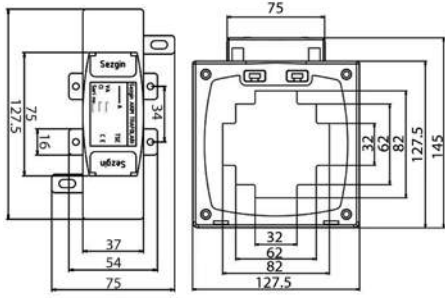

T0.80

ANMA AKIMI (A)	SINIF	GÜÇ (VA)	AD. / ʈ
1500/5 - 1600/5	0,5-01	15	ʈ
		30	
MÜHÜRLÜ TİP			
1500/5 - 1600/5	0,5	15	ʈ

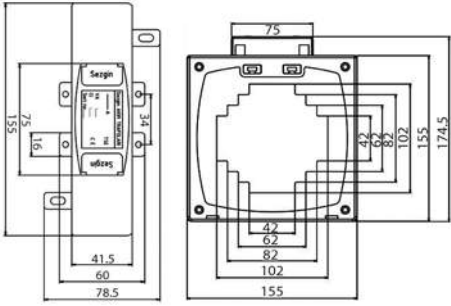

T0.100

ANMA AKIMI (A)	SINIF	GÜÇ (VA)	AD. / ʈ
2000/5	0,5 - 1	15	ʈ
		30	
2500/5	0,5 - 1	15	ʈ
		30	
3000/5	0,5 - 1	15	ʈ
		30	
3200/5	0,5 - 1	15	ʈ
		30	
4000/5	0,5 - 1	30	ʈ
		30	
5000/5	0,5 - 1	30	ʈ
		30	
MÜHÜRLÜ TİP			
2000/5	0,5	15	ʈ
2500/5	0,5	15	
3000/5	0,5	15	
3200/5	0,5	15	

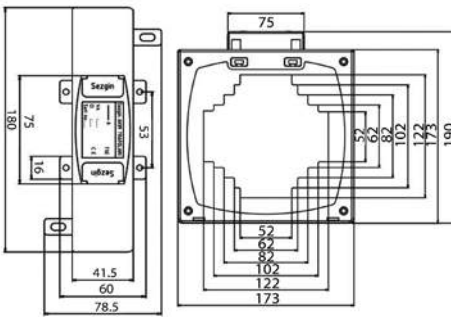

T0.120

ANMA AKIMI (A)	SINIF	GÜÇ (VA)	AD. / ʈ
2000/5	0,5 - 1	15	ʈ
		30	
2500/5	0,5 - 1	15	ʈ
		30	
3000/5	0,5 - 1	15	ʈ
		30	
3200/5	0,5 - 1	15	ʈ
		30	
4000/5	0,5 - 1	30	ʈ
		30	
5000/5	0,5 - 1	30	ʈ
		30	

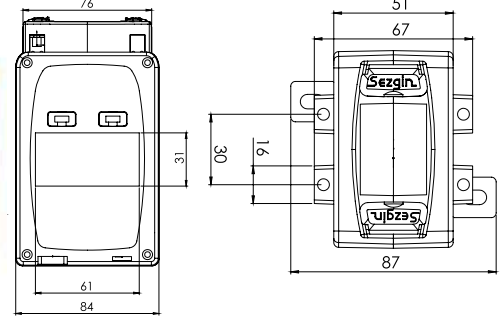

T0.60DR

ANMA AKIMI (A)	SINIF	GÜÇ (VA)	AD. / ʈ
400/5	0,5 - 1	5	ʈ
		10	
500/5 - 600/5	0,5 - 1	5	ʈ
		10	
		15	
700/5 - 750/5 - 800/5	0,5 - 1	5	ʈ
		10	
		15	
1000/5 - 1200/5 - 1250/5	0,5 - 1	5	ʈ
		10	
1500/5 - 1600/5	0,5 - 1	15	ʈ
		30	
		30	
2000/5	0,5 - 1	15	ʈ
		30	

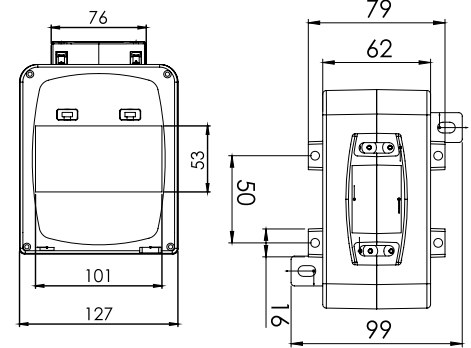

T0.100DR

ANMA AKIMI (A)	SINIF	GÜÇ (VA)	AD. / ʈ
1000/5 - 1200/5 - 1250/5	0,5 - 1	10	ʈ
		15	
1500/5 - 1600/5	0,5 - 1	10	ʈ
		15	
		30	
2000/5	0,5 - 1	15	ʈ
		30	
2500/5	0,5 - 1	15	ʈ
		30	
3000/5	0,5 - 1	15	ʈ
		30	
3200/5	0,5 - 1	15	ʈ
		30	
4000/5	0,5 - 1	30	ʈ
		30	
5000/5	0,5 - 1	30	ʈ
		30	



T0.20



T0.30



T0.40



T0.60



T0.80



T0.100



T0.125

KOD	AÇIKLAMA	AD. / t
T0.20	İç Çap 21 mm. , Dış Çap 63.50 mm.	
T0.30	İç Çap 31 mm. , Dış Çap 72.50 mm.	
T0.40	İç Çap 41 mm. , Dış Çap 76.50 mm.	
T0.60	İç Çap 61 mm. , Dış Çap 110 mm.	
T0.80	İç Çap 81 mm. , Dış Çap 127 mm.	
T0.100	İç Çap 101 mm. , Dış Çap 150 mm.	
T0.125	İç Çap 126 mm. , Dış Çap 172 mm.	



100 A / CL-0,5 !



AKIM TRANSFORMATÖRLERİ

Teknik Özellikler ;

- Yüksek doğruluk opsiyonlarıyla geniş primer ve sekonder akım seçenekleri
- Dar alanlar için düşük maliyetli kompakt ürünler
- Çeşitli montaj opsiyonları: Kolay sabitleme için din ray adaptörü veya güçlü sabitleme için çelik ayak
- Ekstra güvenlik için entegre terminal kapağı, yüksek kesitli pirinç terminal
- Alev geciktiricili ve kendiliğinden sönen ABS kasa materyali.
- Proje ve uygulamalarınıza özel tasarım ve üretim imkanı.

Ürün Çeşitleri ;

- Primer Akım : 5A-4000A, Secondary Current SEKONDER Akım: 1A or 5A
- Doğruluk Sınıfı : 5, 3, 1, 0.5, 0.5S, 0.2 ve 0.2S classes available sınıflar mevcuttur.
- Delik Büyüklüğü: Bara yatağı 125mm, Yuvarlak iletken yuvası Ø 85 mm
- Güç Aralığı : 1VA - 40VA,

Sertifikalar : TSE ve CE

Standartlar : IEC 60044-1, IEC 61869-2, VDE 0414-1, DIN57414, BS3938, BS7626, EN 61869-2

Akım Trafosu Kod Haritası

XX-XXX-XXXX-X-X-XX

Ürün Serisi	Hol Geniliği (mm)	Primer (A)	Sekonder (A)	Doğruluk Sınıfı		Nominal Güç	
				Kod	CL	Kod	(VA)
CK	20	40	1	1	1	01	1
TK	30S	.	5	2	0.5	02	1.5
DK	30	.		3	0.5S	03	2.5
BK	40	.		4	0.1	04	3.75
	60	5000		5	0.1S	05	5
	80			6	0.2	06	7.5
	100			7	0.2S	07	10
	125			8	5	08	12.5
				9	3	09	15
						10	20
						11	25
						12	30
						13	40
						14	50
						15	60

CK20 SERİSİ AKIM TRANSFORMATÖRLERİ



Primer Akımı	CLASS 1.0		CLASS 0.5	
	Ürün Kodu	Nominal Güç (VA)	Ürün Kodu	Nominal Güç (VA)
40	CK20405901	1 (CL.3)	-	-
50	CK20505901	1 (CL.3)	-	-
60	CK20605101	1	-	-
75	CK20755102	1,5	-	-
80	CK20805102	1,5	-	-
100	CK201005102	1,5	CK201005202	1,5
125	CK201255103	2,5	CK201255202	1,5
150	CK201505103	2,5	CK201505202	1,5
160	CK201605103	2,5	CK201605202	1,5
200	CK202005103	2,5	-	-
250	CK202505103	2,5	-	-
300	CK203005103	2,5	-	-

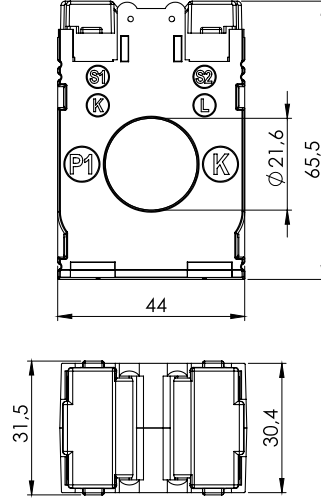

TK30S SERİSİ AKIM TRANSFORMATÖRLERİ



Primer Akımı	CLASS 1.0		CLASS 0.5	
	Ürün Kodu	Nominal Güç (VA)	Ürün Kodu	Nominal Güç (VA)
40	TK30S405802	1.5 (CL.5)	-	-
50	TK30S505802	1.5 (CL.5)	-	-
60	TK30S605902	1.5 (CL.3)	-	-
80	TK30S805101	1	-	-
100	TK30S1005102	1,5	-	-
125	TK30S1255102	1,5	-	1,5
150	TK30S1505103	2,5	TK30S1505203	1,5
160	TK30S1605103	2,5	TK30S1605203	1,5
200	TK30S2005103	2,5	TK30S2005203	1,5
250	TK30S2505103	2,5	TK30S2505203	-
300	TK30S3005104	2,5	TK30S3005203	-
400	TK30S4005104	3,75	TK30S4005203	-
500	TK30S5005104	3,75	TK30S5005203	-
600	TK30S6005105	5	TK30S6005204	-

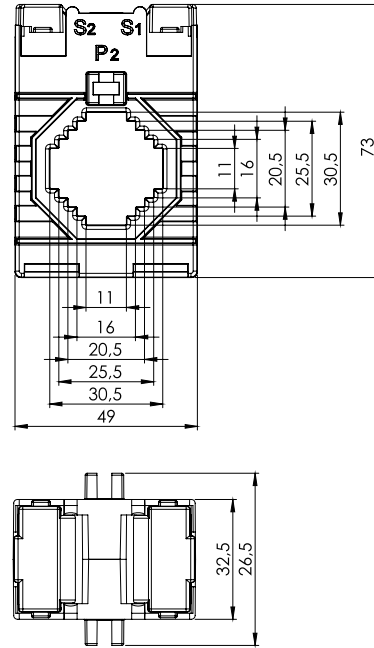

TK40 SERİSİ AKIM TRANSFORMATÖRLERİ



Primer Akımı	CLASS 1.0		CLASS 0.5		CLASS 0.5S	
	Ürün Kodu	Nominal Güç (VA)	Ürün Kodu	Nominal Güç (VA)	Ürün Kodu	Nominal Güç (VA)
200	TK402005103	2,5	TK402005203	2,5	-	-
250	TK402505103	2,5	TK402505203	2,5	-	-
300	TK403005104	3,75	TK403005203	2,5	TK403005302	1,5
400	TK404005105	5	TK404005205	5	TK404005303	2,5
500	TK405005106	7,5	TK405005206	5	TK405005306	7,5
600	TK406005106	7,5	TK406005206	7,5	TK406005306	7,5
800	TK408005107	10	TK408005207	10	TK408005307	10

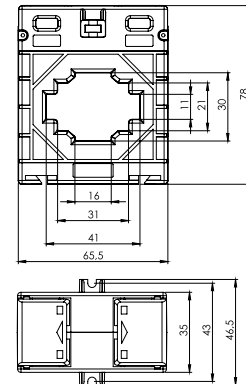

TK30 SERİSİ AKIM TRANSFORMATÖRLERİ



Primer Akımı	CLASS 1.0		CLASS 0.5		CLASS 0.5S	
	CODE	BURDEN (VA)	CODE	BURDEN (VA)	CODE	BURDEN (VA)
60	TK30605903	2.5 (CL.3)	-	-	-	-
80	TK30805102	1,5	-	-	-	-
100	TK301005102	1,5	TK301005202	-	-	-
125	TK301255103	2,5	TK301255203	-	-	-
150	TK301505103	2,5	TK301505203	2,5	TK301505301	1
160	TK301605103	2,5	TK301605203	2,5	TK301605302	1.5
200	TK302005104	3,75	TK302005204	3,75	TK302005302	1.5
250	TK302505105	5	TK302505205	5	TK302505303	2.5
300	TK303005105	5	TK303005205	5	TK303005304	3.75
400	TK304005105	5	TK304005205	5	TK304005305	5
500	TK305005106	7,5	TK305005206	7,5	TK305005306	7,5
600	TK306005107	10	TK306005207	10	TK306005307	10

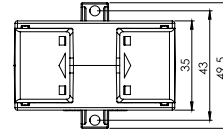
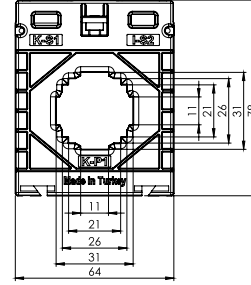

TK60 SERİSİ AKIM TRANSFORMATÖRLERİ



Primer Akımı	CLASS 1.0		CLASS 0.5		CLASS 0.5S	
	CODE	BURDEN (VA)	CODE	BURDEN (VA)	CODE	BURDEN (VA)
600	TK606005108	12,5	TK606005206	7,5	TK606005304	3,75
800	TK608005109	15	TK608005209	15	TK608005307	10
1000	TK6010005111	25	TK6010005211	25	TK6010005310	20
1200	TK6012005111	25	TK6012005211	25	TK6012005310	20
1250	TK6012505112	30	TK6012505211	25	TK6012505310	20
1500	TK6015005112	30	TK6015005212	30	TK6015005312	30

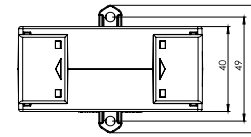
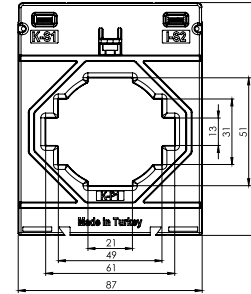

TK80 SERİSİ AKIM TRANSFORMATÖRLERİ



Primer Akımı	CLASS 1.0		CLASS 0.5		CLASS 0.5S	
	Ürün Kodu	Nominal Güç (VA)	Ürün Kodu	Nominal Güç (VA)	Ürün Kodu	Nominal Güç (VA)
800	TK808005110	20	TK808005209	15	TK808005309	15
1000	TK8010005110	20	TK8010005209	15	TK8010005309	15
1200	TK8012005110	20	TK8012005210	20	TK8012005309	15
1250	TK8012505111	25	TK8012505211	25	TK8012505310	20
1500	TK8015005111	25	TK8015005211	25	TK8015005311	25
1600	TK8016005111	25	TK8016005211	25	TK8016005311	25
2000	TK8020005112	30	TK8020005211	25	TK8020005311	25

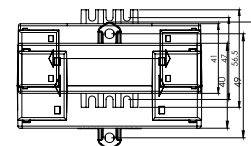
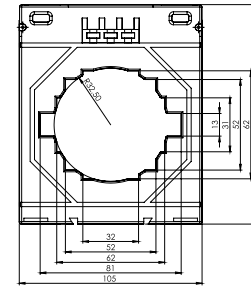

TK100 SERİSİ AKIM TRANSFORMATÖRLERİ



Primer Akımı	CLASS 1.0		CLASS 0.5		CLASS 0.5S	
	Ürün Kodu	Nominal Güç (VA)	Ürün Kodu	Nominal Güç (VA)	Ürün Kodu	Nominal Güç (VA)
1000	TK10010005110	20	TK10010005209	15	TK10010005305	5
1200	TK10012005112	30	TK10012005211	25	TK10012005307	10
1250	TK10012505112	30	TK10012505211	25	TK10012505309	15
1500	TK10015005112	30	TK10015005211	25	TK10015005310	20
1600	TK10016005112	30	TK10016005211	25	TK10016005311	25
2000	TK10020005112	30	TK10020005212	30	TK10020005312	30
2500	TK10025005113	40	TK10025005213	40	TK10025005313	40
3000	TK10030005113	40	TK10030005213	40	TK10030005213	40
3200	TK10032005113	40	TK10032005213	40	TK10032005213	40
4000	TK10040005113	40	TK10040005213	40	TK10040005213	40

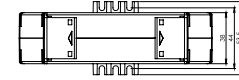
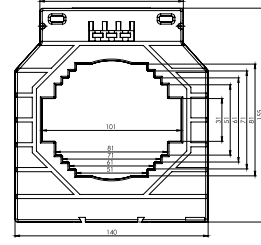

DK125 SERİSİ AKIM TRANSFORMATÖRLERİ



Primer Akımı	CLASS 1.0		CLASS 0.5		CLASS 0.5S	
	Ürün Kodu	Nominal Güç (VA)	Ürün Kodu	Nominal Güç (VA)	Ürün Kodu	Nominal Güç (VA)
1200	DK12512005111	25	DK12512005211	25	DK12512005311	25
1250	DK12512505111	25	DK12512505211	25	DK12512505311	25
1500	DK12515005112	30	DK12515005212	30	DK12515005311	25
1600	DK12516005112	30	DK12516005212	30	DK12516005312	30
2000	DK12520005112	30	DK12520005212	30	DK12520005312	30
2500	DK12525005112	30	DK12525005212	30	DK12525005312	30
3000	DK12530005113	40	DK12530005213	40	DK12530005313	40
3200	DK12532005113	40	DK12532005213	40	DK12532005313	40
4000	DK12540005113	40	DK12540005213	40	DK12540005313	40

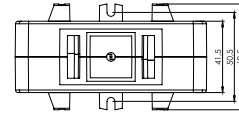
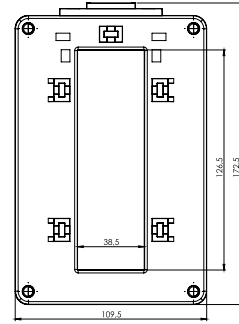

BK SERİSİ AKIM TRANSFORMATÖRLERİ



Primer Akımı	CLASS 0.5		CLASS 0.5S	
	Ürün Kodu	Nominal Güç (VA)	Ürün Kodu	Nominal Güç (VA)
5	BK55205	BK55207	BK55305	BK55307
10	BK105205	BK105207	BK105305	BK105307
15	BK155205	BK155207	BK155305	BK155307
20	BK205205	BK205207	BK205305	BK205307
25	BK255205	BK255207	BK255305	BK255307
30	BK305205	BK305207	BK305305	BK305307
40	BK405205	BK405207	BK405305	BK405307
50	BK505205	BK505207	BK505305	BK505307
60	BK605205	BK605207	BK605305	BK605307
75	BK755205	BK755207	BK755305	BK755307
80	BK805205	BK805207	BK805305	BK805307
100	BK1005205	BK1005207	BK1005305	BK1005307
125	BK1255205	BK1255207	BK1255305	BK1255307
150	BK1505205	BK1505207	BK1505305	BK1505307
200	BK2005205	BK2005207	BK2005305	BK2005307



Delikli ve Ray Tipi Güç Kaynakları



KAPALI TİP (Delikli) SWITCHING GÜÇ KAYNAKLARI



KOD	GÜÇ	ÇIKIŞ	AMPER	BOYUT	AD. / \$
INES-15-05	15 W	5 VDC	3.0 A	99x97x35 mm	10,50 \$
INES-15-12	15 W	12 VDC	1.3 A	99x97x35 mm	10,50 \$
INES-15-24	15 W	24 VDC	0.7 A	99x97x35 mm	10,50 \$
INES-25-05	25 W	5 VDC	5.0 A	99x97x35 mm	12,10 \$
INES-25-12	25 W	12 VDC	2.1 A	99x97x35 mm	12,10 \$
INES-25-24	25 W	24 VDC	1.1 A	99x97x35 mm	12,10 \$
INES-50-05	50 W	5 VDC	10.0 A	159x97x38 mm	13,80 \$
INES-50-12	50 W	12 VDC	4.2 A	159x97x38 mm	13,80 \$
INES-50-24	50 W	24 VDC	2.1 A	159x97x38 mm	13,80 \$
INES-75-05	75 W	5 VDC	15.0 A	159x97x38 mm	16,50 \$
INES-75-12	75 W	12 VDC	6.3 A	159x97x38 mm	16,50 \$
INES-75-24	75 W	24 VDC	3.2 A	159x97x38 mm	16,50 \$
INES-100-05	100 W	5 VDC	20.0 A	199x98x38 mm	18,00 \$
INES-100-12	100 W	12 VDC	8.5 A	199x98x38 mm	18,00 \$
INES-100-15	100 W	15 VDC	6.7 A	199x98x38 mm	18,00 \$
INES-100-24	100 W	24 VDC	4.5 A	199x98x38 mm	18,00 \$
INES-100-48	100 W	48 VDC	2.0 A	199x98x38 mm	18,00 \$
INES-150-05	150 W	5 VDC	30.0 A	199x110x50 mm	26,00 \$
INES-150-12	150 W	12 VDC	12.5 A	199x110x50 mm	26,00 \$
INES-150-15	150 W	15 VDC	10.0 A	199x110x50 mm	26,00 \$
INES-150-24	150 W	24 VDC	6.5 A	199x110x50 mm	26,00 \$
INES-150-48	150 W	48 VDC	3.2 A	199x110x50 mm	26,00 \$

KAPALI TİP (Delikli) SWITCHING GÜÇ KAYNAKLARI



KOD	GÜÇ	ÇIKIŞ	AMPER	BOYUT	AD. / \$
INES S-200-05	200 W	5 VDC	40.0 A	215x115x50 mm	36,00 \$
INES S-200-12	200 W	12 VDC	16.5 A	215x115x50 mm	36,00 \$
INES S-200-15	200 W	15 VDC	13.0 A	215x115x50 mm	36,00 \$
INES S-200-24	200 W	24 VDC	8.3 A	215x115x50 mm	36,00 \$
INES S-200-48	200 W	48 VDC	4.2 A	215x115x50 mm	36,00 \$
INES S-350-05	350 W	5 VDC	50.0 A	215x115x50 mm	45,00 \$
INES S-350-12	350 W	12 VDC	29.0 A	215x115x50 mm	45,00 \$
INES S-350-15	350 W	15 VDC	23.2 A	215x115x50 mm	45,00 \$
INES S-350-24	350 W	24 VDC	14.6 A	215x115x50 mm	45,00 \$
INES S-350-48	350 W	48 VDC	7.3 A	215x115x50 mm	45,00 \$
ISP-500-12	500 W	12 VDC	40.0 A	185x20x93 mm	120,00 \$
ISP-500-15	500 W	15 VDC	32.0 A	185x20x93 mm	120,00 \$
ISP-500-24	500 W	24 VDC	20.0 A	185x20x93 mm	120,00 \$
ISP-500-48	500 W	48 VDC	10.0 A	185x20x93 mm	120,00 \$

KAPALI TİP (Delikli) ULTRA MİNİ SWITCHING GÜÇ KAYNAKLARI



KOD	GÜÇ	ÇIKIŞ	AMPER	BOYUT	AD. / \$
IRS-25-05	25 W	5 V DC	5.0 A	79x51x28 mm	16,00 \$
IRS-25-12	25 W	12 V DC	2.1 A	79x51x28 mm	16,00 \$
IRS-25-24	25 W	24 V DC	1.1 A	79x51x28 mm	16,00 \$
IRS-35-05	35 W	5 V DC	7.0 A	99x82x35 mm	20,00 \$
IRS-35-12	35 W	12 V DC	3.0 A	99x82x35 mm	20,00 \$
IRS-35-24	35 W	24 V DC	1.5 A	99x82x35 mm	20,00 \$

MİNİ GÖSTERGELİ RAYA MONTAJ SWITCHING GÜÇ KAYNAKLARI



MODEL	GÜÇ	ÇIKIŞ	AMPER	BOYUT	AD. / \$
IMR-25-12	25 W	12 VDC	2.1 A	35 x 45 x 90 mm	17,00 \$
IMR-25-24	25 W	24 VDC	1.1 A	35 x 45 x 90 mm	17,00 \$
IMR-50-12	50 W	12 VDC	4.2 A	75.5 x 45 x 102 mm	21,00 \$
IMR-50-24	50 W	24 VDC	2.1 A	75.5 x 45 x 102 mm	21,00 \$
IMR-100-12	100 W	12 VDC	8.3 A	83 x 49 x 100 mm	32,00 \$
IMR-100-24	100 W	24 VDC	4.2 A	83 x 49 x 100 mm	32,00 \$
IMR-150-12	150 W	12 VDC	12.5 A	83 x 49 x 100 mm	41,00 \$
IMR-150-24	150 W	24 VDC	6.25 A	83 x 49 x 100 mm	41,00 \$
IMR-300-12	300 W	12 VDC	25 A	100 x 60 x 110 mm	63,00 \$
IMR-300-24	300 W	24 VDC	12.5 A	100 x 60 x 110 mm	63,00 \$
IMR-500-12	500 W	12 VDC	37.5 A	100 x 90 x 110 mm	90,00 \$
IMR-500-24	500 W	24 VDC	20.8 A	100 x 90 x 110 mm	90,00 \$

RAYA MONTAJLI SWITCHING GÜÇ KAYNAKLARI



KOD	GÜÇ	ÇIKIŞ	AMPER	BOYUT	AD. / \$
IMDR-20-05	20 W	5 V DC	3.0 A	22.5x90x100 mm	17,50 \$
IMDR-20-12	20 W	12 V DC	1.67 A	22.5x90x100 mm	17,50 \$
IMDR-20-24	20 W	24 V DC	1.0 A	22.5x90x100 mm	17,50 \$
IMDR-40-05	40 W	5 V DC	6.0 A	40x90x100 mm	24,60 \$
IMDR-40-12	40 W	12 V DC	3.3 A	40x90x100 mm	24,60 \$
IMDR-40-24	40 W	24 V DC	1.7 A	40x90x100 mm	24,60 \$
IMDR-60-05	60 W	5 V DC	10.0 A	40x90x100 mm	25,00 \$
IMDR-60-12	60 W	12 V DC	5.0 A	40x90x100 mm	25,00 \$
IMDR-60-24	60 W	24 V DC	2.5 A	40x90x100 mm	25,00 \$
IMDR-100-05	100 W	5 V DC	20.0 A	55x90x100 mm	34,50 \$
IMDR-100-12	100 W	12 V DC	8.5 A	55x90x100 mm	34,50 \$
IMDR-100-24	100 W	24 V DC	4.5 A	55x90x100 mm	34,50 \$

RAYA MONTAJLI SWITCHING GÜÇ KAYNAKLARI



KOD	GÜÇ	ÇIKIŞ	AMPER	BOYUT	AD. / \$
IDR-15-05	15 W	5 V DC	3.0 A	25x91x56 mm	15,00 \$
IDR-15-12	15 W	12 V DC	1.3 A	25x91x56 mm	15,00 \$
IHDR-15-24	15 W	24 V DC	0.7 A	25x91x56 mm	15,00 \$
IDR-30-12	30 W	12 V DC	2.0 A	78x93x56 mm	18,50 \$
IDR-30-24	30 W	24 V DC	1.5 A	78x93x56 mm	18,50 \$
IDR-45-12	45 W	12 V DC	3.5 A	93x78x67 mm	22,00 \$
IDR-45-24	45 W	24 V DC	2.0 A	93x78x67 mm	22,00 \$
IDR-60-05	60 W	5 V DC	6.5 A	93x78x67 mm	25,00 \$
IDR-60-12	60 W	12 V DC	4.5 A	93x78x67 mm	25,00 \$
IDR-60-24	60 W	24 V DC	2.5 A	93x78x67 mm	25,00 \$
IDR-75-12	75 W	12 V DC	6.3 A	55.5x125.2x100 mm	33,00 \$
IDR-75-24	75 W	24 V DC	3.2 A	55.5x125.2x100 mm	33,00 \$
IDR-100-12	100 W	12 V DC	8.5 A	98x90x56 mm	35,00 \$
IDR-100-24	100 W	24 V DC	4.5 A	98x90x56 mm	35,00 \$
IDR-120-12	120 W	12 V DC	10.0 A	65.5x125.2x100 mm	40,00 \$
IDR-120-24	120 W	24 V DC	5.0 A	65.5x125.2x100 mm	40,00 \$
IEDR-150-12	150 W	12 V DC	12,5 A	40x125,2x113,5 mm	36,40 \$
IEDR-150-24	150 W	24 V DC	6.5 A	40x125,2x113,5 mm	36,40 \$
IDRP-240-24	240 W	24 V DC	10.0 A	125.2x125.2x100 mm	64,00 \$
IDRP-240-48	240 W	48 V DC	5.0 A	125.2x125.2x100 mm	64,00 \$
IDRP-480-24	480 W	24 V DC	20.0 A	227x125.2x100 mm	145,00 \$
IDRP-480-48	480 W	48 V DC	10.0 A	227x125.2x100 mm	145,00 \$
IDRT-240-24	240 W	24 V DC	10.0 A	227x125.2x100 mm	96,00 \$
IDRT-480-24	480 W	48 V DC	20.0 A	227x125.2x100 mm	150,00 \$

Kafalı-Bayonet-Mantel &
Özel Tip Termokupllar





ISISO ENDÜSTRİYEL OTOMASYON ÜRÜNLERİ

Piston Sensörleri
Işık Bariyerleri, Renk Fotoselleri, Reflektörler
Fiber Optik Anfi & Kablolar, Konnektörlü Kablolar



Analog Girişli Trifaze Lineer (4–20mA) SSR'ler





ISISO ENDÜSTRİYEL OTOMASYON ÜRÜNLERİ

Hız Kontroller Servo Motorlar Servo Sürücüler





SICAK YOLLUK KONTROL CİHAZI

Çok ve tek gözlü sıcak yolluklu kalıpların ısı kontrol sistemidir. 1 modülden 10 modüle kadar stoklarımızda mevcut olup, 32 modüle kadar ihtiyaç sayısına göre özel ısı kontrol cihazı üretimi yapmaktayız. Isı kontrol cihazları SSR, sigorta ve ara kablo gibi elemanları ile tamamlanmış çalıştırılmaya hazır modüllerdir.

- 2x4 hane göstergeli.
- Ön panel tuşlarından kolayca ayarlanabilir özellik.
- Seçilebilir frekans.
- Giriş işareti 0.001 ile 9.999 arasında istenilen değer ile çarpılarak kalibrasyon yapılabilir.
- Desibel nokta ile 1. ile 3. basamak arasında ayarlanabilir.
- Sensör giriş tipi tuş takımında seçilebilir. (Fe-const, pt100, ni-cr-ni vs...)
- Çıkış kontağı sürekli çıkış veya 0.1 ile 999.9 saniye aralığında çekecek şekilde ayarlanabilir.
- Seçilebilir parametre güvenliği.
- Alarm çıkışlı olup istenen ısının fazla yükselmesi halinde ikaz özelliği.
- Ürünlerimiz standart olarak 3 mt. besleme, 3 mt. ısıtıcı kontrol kabloları ile birlikte sevek edilir. Farklı kablo boyu talepleriniz için satış temsilcilerimiz ile irtibata geçiniz.
- Talebinize göre opsiyonel kontrolörlerle imalat yapılabilir.

MODEL	AD.
1 Gözlü sıcak yolluk kontrol cihazı	☎
2 Gözlü sıcak yolluk kontrol cihazı	☎
4 Gözlü sıcak yolluk kontrol cihazı	☎
6 Gözlü sıcak yolluk kontrol cihazı	☎
8 Gözlü sıcak yolluk kontrol cihazı	☎
10 Gözlü sıcak yolluk kontrol cihazı	☎
12 Gözlü sıcak yolluk kontrol cihazı	☎

Farklı sayıda göz seçenekleri için



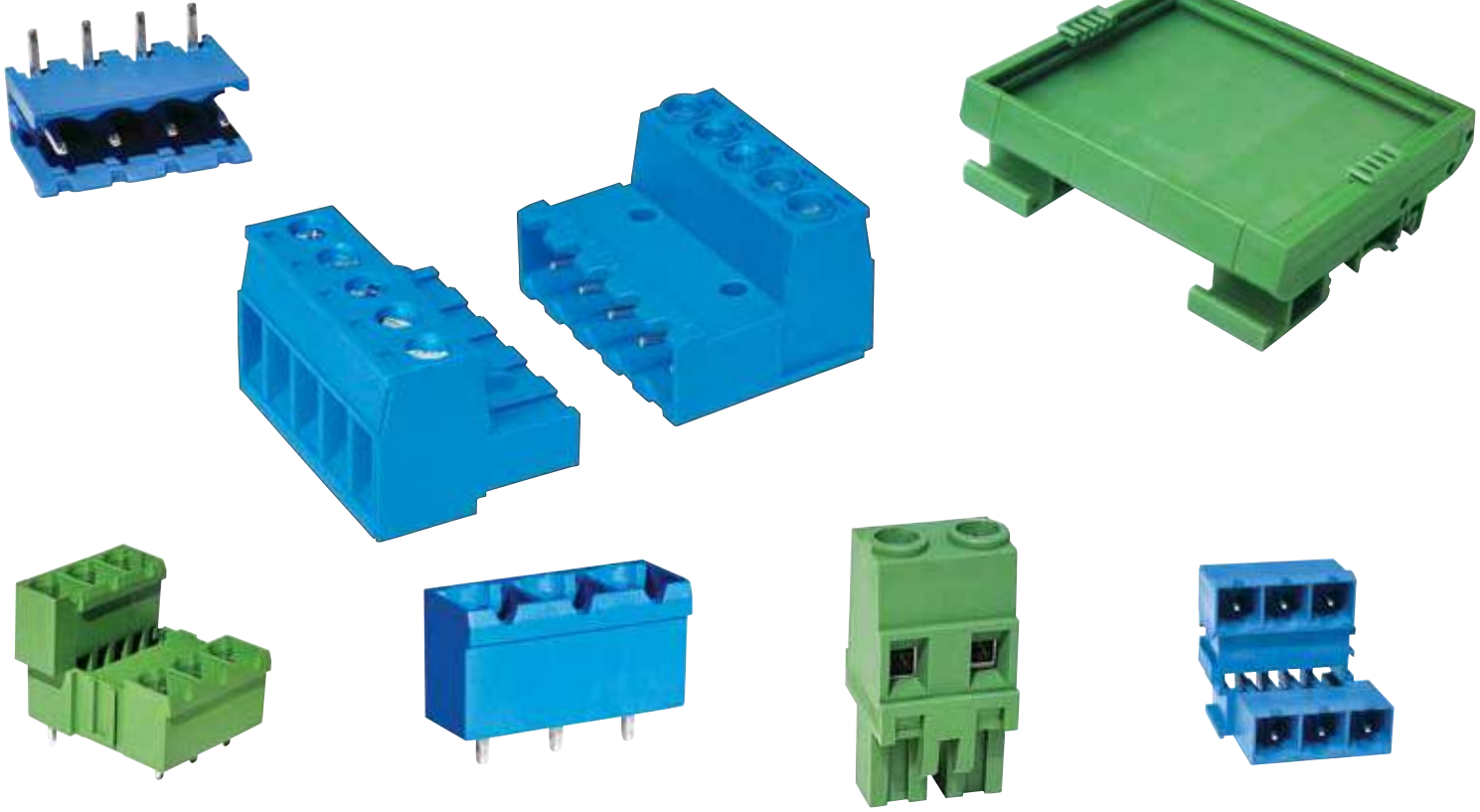

SOKETLİ KLEMENS SERİSİ

3.81 mm DIŞI

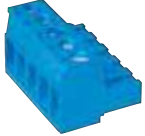

KOMBİNE ÜRÜNLER

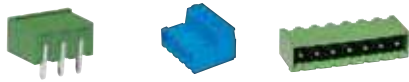

• SBDK 3,81-E1 • SBDK 3,81-KB • SBDK 3,81-E2

3.81 mm ERKEK (90°)



KOMBİNE ÜRÜNLER

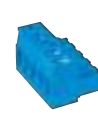

• SBDK 3,81-KB

PİN	KOD	SİPARİŞ NO		AD. / \$	K. AD.
2	SBDK 3,81-D/2	10.011	11.011	0,2664 \$	200
3	SBDK 3,81-D/3	10.013	11.013	0,3996 \$	200
4	SBDK 3,81-D/4	10.015	11.015	0,5328 \$	200
5	SBDK 3,81-D/5	10.017	11.017	0,6660 \$	200
6	SBDK 3,81-D/6	10.019	11.019	0,7992 \$	200
7	SBDK 3,81-D/7	10.021	11.021	0,9324 \$	200
8	SBDK 3,81-D/8	10.023	11.023	1,0656 \$	200
12	SBDK 3,81-D/12	10.025	11.025	1,5984 \$	200
16	SBDK 3,81-D/16	10.027	11.027	1,1312 \$	200

PİN	KOD	SİPARİŞ NO		AD. / \$	K. AD.
2	SBDK 3,81-E1/2	10.050	11.050	0,0974 \$	200
3	SBDK 3,81-E1/3	10.052	11.052	0,1461 \$	200
4	SBDK 3,81-E1/4	10.054	11.054	0,1948 \$	200
5	SBDK 3,81-E1/5	10.056	11.056	0,2435 \$	200
6	SBDK 3,81-E1/6	10.058	11.058	0,2922 \$	200
7	SBDK 3,81-E1/7	10.060	11.060	0,3409 \$	200
8	SBDK 3,81-E1/8	10.062	11.062	0,3896 \$	200
12	SBDK 3,81-E1/12	10.064	11.064	0,5357 \$	200
16	SBDK 3,81-E1/16	10.066	11.066	0,7305 \$	200

3.81 mm ERKEK (180°)



KOMBİNE ÜRÜNLER

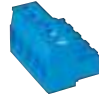

• SBDK 3,81-D

3.81 mm KABLO BİRLEŞTİRİCİ ERKEK

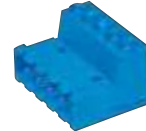

KOMBİNE ÜRÜNLER



• SBDK 3,81-D



• DIS 3,81/KB

PİN	KOD	SİPARİŞ NO		AD. / \$	K. AD.
2	SBDK 3,81-E2/2	10.100	11.100	0,0974 \$	200
3	SBDK 3,81-E2/3	10.103	11.103	0,1461 \$	200
4	SBDK 3,81-E2/4	10.106	11.106	0,1948 \$	200
5	SBDK 3,81-E2/5	10.109	11.109	0,2435 \$	200
6	SBDK 3,81-E2/6	10.112	11.112	0,2922 \$	200
7	SBDK 3,81-E2/7	10.115	11.115	0,3409 \$	200
8	SBDK 3,81-E2/8	10.118	11.118	0,3896 \$	200
12	SBDK 3,81-E2/12	10.121	11.121	0,5357 \$	200
16	SBDK 3,81-E2/16	10.124	11.124	0,7305 \$	200

PİN	KOD	SİPARİŞ NO		AD. / \$	K. AD.
2	SKBK 3,81-E/2	10.151	11.151	0,3450 \$	200
3	SKBK 3,81-E/3	10.153	11.153	0,5175 \$	200
4	SKBK 3,81-E/4	10.155	11.155	0,6900 \$	200
5	SKBK 3,81-E/5	10.157	11.157	0,8625 \$	200
6	SKBK 3,81-E/6	10.159	11.159	1,0350 \$	200
7	SKBK 3,81-E/7	10.161	11.161	1,2075 \$	200
8	SKBK 3,81-E/8	10.163	11.163	1,3800 \$	200

5.08 mm Dişi

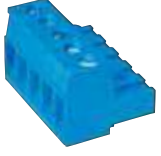

KOMBİNE ÜRÜNLER

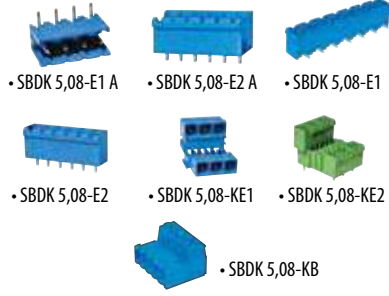

PİN	KOD	SİPARİŞ NO		AD. / \$	K. AD.
2	SBDK 5,08-D/2	10.202	11.202	0,2364 \$	200
3	SBDK 5,08-D/3	10.203	11.203	0,3456 \$	100
4	SBDK 5,08-D/4	10.204	11.204	0,4720 \$	100
5	SBDK 5,08-D/5	10.205	11.205	0,5910 \$	100
6	SBDK 5,08-D/6	10.206	11.206	0,7092 \$	100
7	SBDK 5,08-D/7	10.207	11.207	0,8274 \$	100
8	SBDK 5,08-D/8	10.208	11.208	0,9456 \$	100
9	SBDK 5,08-D/9	10.209	11.209	1,0638 \$	100
10	SBDK 5,08-D/10	10.210	11.210	1,1820 \$	50
11	SBDK 5,08-D/11	10.211	11.211	1,3002 \$	50
12	SBDK 5,08-D/12	10.212	11.212	1,4184 \$	50
13	SBDK 5,08-D/13	10.213	11.213	1,5366 \$	50
14	SBDK 5,08-D/14	10.214	11.214	1,6548 \$	50
15	SBDK 5,08-D/15	10.215	11.215	1,7730 \$	50
16	SBDK 5,08-D/16	10.216	11.216	1,8912 \$	50
17	SBDK 5,08-D/17	10.217	11.217	2,0094 \$	50
18	SBDK 5,08-D/18	10.218	11.218	2,1276 \$	50
19	SBDK 5,08-D/19	10.219	11.219	2,2458 \$	25
20	SBDK 5,08-D/20	10.220	11.220	2,3640 \$	25
21	SBDK 5,08-D/21	10.221	11.221	2,4822 \$	25
22	SBDK 5,08-D/22	10.222	11.222	2,6004 \$	25
23	SBDK 5,08-D/23	10.223	11.223	2,7186 \$	25
24	SBDK 5,08-D/24	10.224	11.224	2,8368 \$	25
25	SBDK 5,08-D/25	10.225	11.225	2,9550 \$	25

SOKETLİ KLEMENS SERİSİ (5.08 mm)

5.08 mm DİK Dişi



KOMBİNE ÜRÜNLER



• SBDK 5,08-E2 A

• SBDK 5,08-E2

PİN	KOD	SİPARİŞ NO		AD. / \$	K. AD.
2	SBDK 5,08-DD/2	10.252	11.252	0,3028 \$	200
3	SBDK 5,08-DD/3	10.253	11.253	0,4542 \$	100
4	SBDK 5,08-DD/4	10.254	11.254	0,6056 \$	100
5	SBDK 5,08-DD/5	10.255	11.255	0,7570 \$	100
6	SBDK 5,08-DD/6	10.256	11.256	0,9084 \$	100
7	SBDK 5,08-DD/7	10.257	11.257	1,0598 \$	100
8	SBDK 5,08-DD/8	10.258	11.258	1,2112 \$	100
9	SBDK 5,08-DD/9	10.259	11.259	1,3626 \$	100
10	SBDK 5,08-DD/10	10.260	11.260	1,5140 \$	50
11	SBDK 5,08-DD/11	10.261	11.261	1,6654 \$	50
12	SBDK 5,08-DD/12	10.262	11.262	1,8168 \$	50

5.08 mm ERKEK 90° AÇIK

KOMBİNE ÜRÜNLER



• SBDK 5,08-D

PİN	KOD	SİPARİŞ NO		AD. / \$	K. AD.
2	SBDK 5,08-E1A/2	10.302	11.302	0,0902 \$	200
3	SBDK 5,08-E1A/3	10.303	11.303	0,1353 \$	100
4	SBDK 5,08-E1A/4	10.304	11.304	0,1804 \$	100
5	SBDK 5,08-E1A/5	10.305	11.305	0,2255 \$	100
6	SBDK 5,08-E1A/6	10.306	11.306	0,2706 \$	100
7	SBDK 5,08-E1A/7	10.307	11.307	0,3157 \$	100
8	SBDK 5,08-E1A/8	10.308	11.308	0,3608 \$	100
9	SBDK 5,08-E1A/9	10.309	11.309	0,4059 \$	100
10	SBDK 5,08-E1A/10	10.310	11.310	0,4510 \$	50
11	SBDK 5,08-E1A/11	10.311	11.311	0,4961 \$	50
12	SBDK 5,08-E1A/12	10.312	11.312	0,5412 \$	50
13	SBDK 5,08-E1A/13	10.313	11.313	0,5863 \$	50
14	SBDK 5,08-E1A/14	10.314	11.314	0,6314 \$	50
15	SBDK 5,08-E1A/15	10.315	11.315	0,6765 \$	50
16	SBDK 5,08-E1A/16	10.316	11.316	0,7216 \$	50
17	SBDK 5,08-E1A/17	10.317	11.317	0,7667 \$	50
18	SBDK 5,08-E1A/18	10.318	11.318	0,8118 \$	50
19	SBDK 5,08-E1A/19	10.319	11.319	0,8569 \$	25
20	SBDK 5,08-E1A/20	10.320	11.320	0,9020 \$	25
21	SBDK 5,08-E1A/21	10.321	11.321	0,9471 \$	25
22	SBDK 5,08-E1A/22	10.322	11.322	0,9922 \$	25
23	SBDK 5,08-E1A/23	10.323	11.323	1,0373 \$	25
24	SBDK 5,08-E1A/24	10.324	11.324	1,0824 \$	25
25	SBDK 5,08-E1A/25	10.325	11.325	1,1275 \$	25

SOKETLİ KLEMENS SERİSİ (5.08 mm)

5.08 mm ERKEK (180°) AÇIK

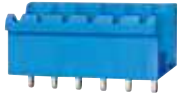

KOMBİNE ÜRÜNLER



• SBDK 5,08-D • SBDK 5,08-DD

PİN	KOD	SİPARİŞ NO		AD. / \$	K. AD.
2	SBDK 5,08-E2A/2	10.352	11.352	0,0902 \$	200
3	SBDK 5,08-E2A/3	10.353	11.353	0,1353 \$	100
4	SBDK 5,08-E2A/4	10.354	11.354	0,1804 \$	100
5	SBDK 5,08-E2A/5	10.355	11.355	0,2255 \$	100
6	SBDK 5,08-E2A/6	10.356	11.356	0,2706 \$	100
7	SBDK 5,08-E2A/7	10.357	11.357	0,3157 \$	100
8	SBDK 5,08-E2A/8	10.358	11.358	0,3608 \$	100
9	SBDK 5,08-E2A/9	10.359	11.359	0,4059 \$	100
10	SBDK 5,08-E2A/10	10.360	11.360	0,4510 \$	50
11	SBDK 5,08-E2A/11	10.361	11.361	0,4961 \$	50
12	SBDK 5,08-E2A/12	10.362	11.362	0,5412 \$	50
13	SBDKS 5,08-E2A/13	10.363	11.363	0,5863 \$	50
14	SBDK 5,08-E2A/14	10.364	11.364	0,6314 \$	50
15	SBDK 5,08-E2A/15	10.365	11.365	0,6765 \$	50
16	SBDK 5,08-E2A/16	10.366	11.366	0,7216 \$	50
17	SBDK 5,08-E2A/17	10.367	11.367	0,7667 \$	50
18	SBDK 5,08-E2A/18	10.368	11.368	0,8118 \$	50
19	SBDK 5,08-E2A/19	10.369	11.369	0,8569 \$	25
20	SBDK 5,08-E2A/20	10.370	11.370	0,9020 \$	25
21	SBDK 5,08-E2A/21	10.371	11.371	0,9471 \$	25
22	SBDK 5,08-E2A/22	10.372	11.372	0,9922 \$	25
23	SBDK 5,08-E2A/23	10.373	11.373	1,0373 \$	25
24	SBDK 5,08-E2A/24	10.374	11.374	1,0824 \$	25
25	SBDK 5,08-E2A/25	10.375	11.375	1,1275 \$	25

5.08 mm ERKEK 90° KAPALI



KOMBİNE ÜRÜNLER



• SBDK 5,08-D

PİN	KOD	SİPARİŞ NO		AD. / \$	K. AD.
2	SBDK 5,08-E1/2	10.402	11.402	0,1086 \$	200
3	SBDK 5,08-E1/3	10.403	11.403	0,1629 \$	100
4	SBDK 5,08-E1/4	10.404	11.404	0,2172 \$	100
5	SBDK 5,08-E1/5	10.405	11.405	0,2715 \$	100
6	SBDK 5,08-E1/6	10.406	11.406	0,3258 \$	100
7	SBDK 5,08-E1/7	10.407	11.407	0,3801 \$	100
8	SBDK 5,08-E1/8	10.408	11.408	0,4344 \$	100
9	SBDK 5,08-E1/9	10.409	11.409	0,4887 \$	100
10	SBDK 5,08-E1/10	10.410	11.410	0,5430 \$	50
11	SBDK 5,08-E1/11	10.411	11.411	0,5973 \$	50
12	SBDK 5,08-E1/12	10.412	11.412	0,6516 \$	50
25	SBDK 5,08-E1/15	10.425	11.425	1,3575 \$	25

SOKETLİ KLEMENS SERİSİ (5.08 mm)

5.08 mm ERKEK (180°) KAPALI



KOMBİNE ÜRÜNLER



• SBDK 5,08-D • SBDK 5,08-DD

PİN	KOD	SİPARİŞ NO		AD. / \$	K. AD.
2	SBDK 5,08-E2/2	10.452	11.452	0,1086 \$	200
3	SBDK 5,08-E2/3	10.453	11.453	0,1629 \$	100
4	SBDK 5,08-E2/4	10.454	11.454	0,2172 \$	100
5	SBDK 5,08-E2/5	10.455	11.455	0,2715 \$	100
6	SBDK 5,08-E2/6	10.456	11.456	0,3258 \$	100
7	SBDK 5,08-E2/7	10.457	11.457	0,3801 \$	100
8	SBDK 5,08-E2/8	10.458	11.458	0,4344 \$	100
9	SBDK 5,08-E2/9	10.459	11.459	0,4887 \$	100
10	SBDK 5,08-E2/10	10.460	11.460	0,5430 \$	50
11	SBDK 5,08-E2/11	10.461	11.461	0,5973 \$	50
12	SBDK 5,08-E2/12	10.462	11.462	0,6516 \$	50
25	SBDK 5,08-E2/25	10.475	11.475	1,3575 \$	25

5.08 mm ÇİFT KATLI ERKEK (90°)



KOMBİNE ÜRÜNLER



• SBDK 5,08-D

PİN	KOD	SİPARİŞ NO		AD. / \$	K. AD.
2x2	SBDK 5,08 KE1/2	10.500	11.500	0,2692 \$	100
2x3	SBDK 5,08 KE1/3	10.525	11.525	0,4038 \$	50

5.08 mm ÇİFT KATLI ERKEK (180°)



KOMBİNE ÜRÜNLER



• SBDK 5,08-D • SBDK 5,08-DD

PİN	KOD	SİPARİŞ NO		AD. / \$	K. AD.
2x2	SBDK 5,08 KE2/2	10.550	11.550	0,2692 \$	100
2x3	SBDK 5,08 KE2/3	10.575	11.575	0,4038 \$	50

7.62 mm DİŞİ



KOMBİNE ÜRÜNLER

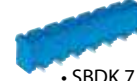

• SBDK 7,62-E1

• SBDK 7,62-E2

• SBDK 7,62-KE1

• SBDK 7,62-KE2

PİN	KOD	SİPARİŞ NO		AD. / \$	K. AD.
2	SBDK 7,62-D/2	10.702	11.702	0,3210 \$	200
3	SBDK 7,62-D/3	10.703	11.703	0,4815 \$	100
4	SBDK 7,62-D/4	10.704	11.704	0,6420 \$	100
5	SBDK 7,62-D/5	10.705	11.705	0,8025 \$	100
6	SBDK 7,62-D/6	10.706	11.706	0,9630 \$	100
7	SBDK 7,62-D/7	10.707	11.707	1,1235 \$	50
8	SBDK 7,62-D/8	10.708	11.708	1,2840 \$	50
9	SBDK 7,62-D/9	10.709	11.709	1,4445 \$	50
10	SBDK 7,62-D/10	10.710	11.710	1,6050 \$	50
11	SBDK 7,62-D/11	10.711	11.711	1,7655 \$	50
12	SBDK 7,62-D/12	10.712	11.712	1,9260 \$	50

SOKETLİ KLEMENS SERİSİ (5.08 mm)

5.08 mm KAB. BİR. ERKEK

KOMBİNE ÜRÜNLER

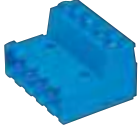

• SBDK 5,08-D



• SBDK 5,08-DD

PİN	KOD	SİPARİŞ NO		AD. / \$	K. AD.
2	SKBK 5,08-KB/2	10.602	11.602	0,3536 \$	200
3	SKBK 5,08-KB/3	10.603	11.603	0,5304 \$	100
4	SKBK 5,08-KB/4	10.604	11.604	0,7072 \$	100
5	SKBK 5,08-KB/5	10.605	11.605	0,8840 \$	100
6	SKBK 5,08-KB/6	10.606	11.606	1,0608 \$	100
7	SKBK 5,08-KB/7	10.607	11.607	1,2376 \$	100
8	SKBK 5,08-KB/8	10.608	11.608	1,4144 \$	100
9	SKBK 5,08-KB/9	10.609	11.609	1,5912 \$	100
10	SKBK 5,08-KB/10	10.610	11.610	1,7680 \$	50
11	SKBK 5,08-KB/11	10.611	11.611	1,9448 \$	50
12	SKBK 5,08-KB/12	10.612	11.612	2,1216 \$	50
13	SKBK 5,08-KB/13	10.613	11.613	2,2984 \$	50
14	SKBK 5,08-KB/14	10.614	11.614	2,4752 \$	50
15	SKBK 5,08-KB/15	10.615	11.615	2,6520 \$	50
16	SKBK 5,08-KB/16	10.616	11.616	2,8288 \$	50
17	SKBK 5,08-KB/17	10.617	11.617	3,0056 \$	50
18	SKBK 5,08-KB/18	10.618	11.618	3,1824 \$	50
19	SKBK 5,08-KB/19	10.619	11.619	3,3592 \$	25
20	SKBK 5,08-KB/20	10.620	11.620	3,5360 \$	25
21	SKBK 5,08-KB/21	10.621	11.621	3,7128 \$	25
22	SKBK 5,08-KB/22	10.622	11.622	3,8896 \$	25
23	SKBK 5,08-KB/23	10.623	11.623	4,0664 \$	25
24	SKBK 5,08-KB/24	10.624	11.624	4,2432 \$	25
25	SKBK 5,08-KB/25	10.625	11.625	4,4200 \$	25

SOKETLİ KLEMENS SERİSİ (7.62 mm)

7.62 mm DİK DİŞİ

KOMBİNE ÜRÜNLER



• SBDK 7,62-E2



• SBDK 7,62-KE2

PİN	KOD	SİPARİŞ NO		AD. / \$	K. AD.
2	SBDK 7,62-DD/2	10.752	11.752	0,3752 \$	200
3	SBDK 7,62-DD/3	10.753	11.753	0,5628 \$	100
4	SBDK 7,62-DD/4	10.754	11.754	0,7504 \$	100
5	SBDK 7,62-DD/5	10.755	11.755	0,9380 \$	100
6	SBDK 7,62-DD/6	10.756	11.756	1,1256 \$	100
7	SBDK 7,62-DD/7	10.757	11.757	1,3132 \$	50
8	SBDK 7,62-DD/8	10.758	11.758	1,5008 \$	50
9	SBDK 7,62-DD/9	10.759	11.759	1,6884 \$	50
10	SBDK 7,62-DD/10	10.760	11.760	1,8760 \$	50
11	SBDK 7,62-DD/11	10.761	11.761	2,0636 \$	50
12	SBDK 7,62-DD/12	10.762	11.762	2,2512 \$	50

SOKETLİ KLEMENS SERİSİ (7.62 mm)

7.62 mm ERKEK 90°

KOMBİNE ÜRÜNLER



• SBDK 5,08-DD

PİN	KOD	SİPARİŞ NO		AD. / \$	K. AD.
2	SBDK 7,62-E1/2	10.802	11.802	0,1216 \$	200
3	SBDK 7,62-E1/3	10.803	11.803	0,1824 \$	100
4	SBDK 7,62-E1/4	10.804	11.804	0,2432 \$	100
5	SBDK 7,62-E1/5	10.805	11.805	0,3040 \$	100
6	SBDK 7,62-E1/6	10.806	11.806	0,3648 \$	100
7	SBDK 7,62-E1/7	10.807	11.807	0,4256 \$	50
8	SBDK 7,62-E1/8	10.808	11.808	0,4864 \$	50
9	SBDK 7,62-E1/9	10.809	11.809	0,5472 \$	50
10	SBDK 7,62-E1/10	10.810	11.810	0,6080 \$	50
11	SBDK 7,62-E1/11	10.811	11.811	0,6688 \$	50
12	SBDK 7,62-E1/12	10.812	11.812	0,7296 \$	50

7.62 mm ERKEK 180°

KOMBİNE ÜRÜNLER



• SBDK 7,62-D



• SBDK 7,62-DD

PİN	KOD	SİPARİŞ NO		AD. / \$	K. AD.
2	SBDK 7,62-E2/2	10.852	11.852	0,1216 \$	200
3	SBDK 7,62-E2/3	10.853	11.853	0,1824 \$	100
4	SBDK 7,62-E2/4	10.854	11.854	0,2432 \$	100
5	SBDK 7,62-E2/5	10.855	11.855	0,3040 \$	100
6	SBDK 7,62-E2/6	10.856	11.856	0,3648 \$	100
7	SBDK 7,62-E2/7	10.857	11.857	0,4256 \$	50
8	SBDK 7,62-E2/8	10.858	11.858	0,4864 \$	50
9	SBDK 7,62-E2/9	10.859	11.859	0,5472 \$	50
10	SBDK 7,62-E2/10	10.860	11.860	0,6080 \$	50
11	SBDK 7,62-E2/11	10.861	11.861	0,6688 \$	50
12	SBDK 7,62-E2/12	10.862	11.862	0,7296 \$	50

7.62 mm ÇİFT KATLI ERKEK 90°

KOMBİNE ÜRÜNLER



• SBDK 7,62-D

PİN	KOD	SİPARİŞ NO		AD. / \$	K. AD.
2	SBDK7,62 KE1/2	10.900	11.900	0,3330 \$	100
3	SBDK 7,62 KE1/3	10.925	11.925	0,4995 \$	50

7.62 mm ÇİFT KATLI ERKEK 180°

KOMBİNE ÜRÜNLER



• SBDK 7,62-D



• SBDK 7,62-DD

PİN	KOD	SİPARİŞ NO		AD. / \$	K. AD.
2	SBDK 7,62 KE2/2	10.950	11.950	0,3330 \$	100
3	SBDK 7,62 KE2/3	10.975	11.975	0,4995 \$	50

MODÜLER BASKILI DEVRE KLEMENSLERİ

5.08 mm MODÜL



ÜRÜN	PİN	KOD	SİPARİŞ NO		AD. / \$	K. AD.
NO: 0	2	MBDK 5,08-0/2	20.100	21.100	0,1040 \$	500
NO: 0	3	MBDK 5,08-0/3	20.140	21.140	0,1560 \$	500
NO: 1	2	MBDK 5,08-1/2	20.180	21.180	0,1584 \$	250
NO: 1	3	MBDK 5,08-1/3	20.220	21.220	0,2376 \$	250
NO: 1	2	MBDK 5,08-1/2L	20.260	21.260	0,1760 \$	250
NO: 1	3	MBDK 5,08-1/3L	20.300	21.300	0,2640 \$	250
NO: 2	2	MBDK 5,08-2/2	20.340	21.340	0,3088 \$	200
NO: 2	3	MBDK 5,08-2/3	20.380	21.380	0,4632 \$	200
NO: 2	10	MBDK 5,08-2/10	20.420	21.420	1,5440 \$	50

SOKETLİ KLEMENS SERİSİ (7.62 mm)

7.62 mm ERKEK (180°) AÇIK

KOMBİNE ÜRÜNLER

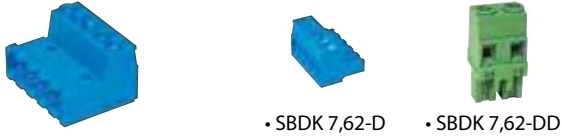

• SBDK 7,62-D • SBDK 7,62-DD

PİN	KOD	SİPARİŞ NO		AD. / \$	K. AD.
2	SKBK 7,62-KB/E	10.902	11.902	0,3672 \$	200
3	SKBK 7,62-KB/E	10.903	11.903	0,5508 \$	100
4	SKBK 7,62-KB/E	10.904	10.904	0,7344 \$	100
5	SKBK 7,62-KB/E	10.905	11.905	0,9180 \$	100
6	SKBK 7,62-KB/E	10.906	11.906	1,1016 \$	100
7	SKBK 7,62-KB/E	10.907	11.907	1,2852 \$	50
8	SKBK 7,62-KB/E	10.908	11.908	1,4688 \$	50
9	SKBK 7,62-KB/E	10.909	11.909	1,6524 \$	50
10	SKBK 7,62-KB/E	10.910	11.910	1,8360 \$	50
11	SKBK 7,62-KB/E	10.911	11.911	2,0196 \$	50
12	SKBK 7,62-KB/E	10.912	11.912	2,2032 \$	50

VİDASIZ KLEMENS SERİSİ

5.08 x 7.62 mm VİDASIZ



PİN	KOD	SİPARİŞ NO		AD. / \$	K. AD.
2	VBDK/2	31.120	34.120	0,1620 \$	200
3	VBDK/3	31.160	34.160	0,2430 \$	100
4	VBDK/4	31.200	34.200	0,3240 \$	100
5	VBDK/5	31.240	34.240	0,4050 \$	100
6	VBDK/6	31.280	34.280	0,4860 \$	100
7	VBDK/7	31.320	34.320	0,5670 \$	100
8	VBDK/8	31.360	34.360	0,6480 \$	100
9	VBDK/9	31.400	34.400	0,7290 \$	100
10	VBDK/10	31.440	34.440	0,8100 \$	50
11	VBDK/11	31.480	34.480	0,8910 \$	50
12	VBDK/12	31.520	34.520	0,9720 \$	50

MODÜLER BASKILI DEVRE KLEMENSLERİ

7.62 mm MODÜL



ÜRÜN	PİN	KOD	SİPARİŞ NO		AD. / \$	K. AD.
NO: 2	2	MBDK 7,62-2/2	20.460	21.460	0,3310 \$	200
NO: 2	3	MBDK 7,62-2/3	20.500	21.500	0,4965 \$	200

9.52 x 7.62 mm MODÜL



KOD	ÜRÜN	SİPARİŞ NO		AD. / \$	K. AD.
MBDK 9,52-1	9.52	20.540	21.540	0,6440 \$	100

10.16x10.6 mm MODÜL

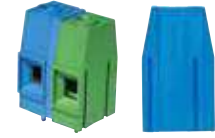

KOD	ÜRÜN	SİPARİŞ NO		AD. / \$	K. AD.
MBDK 10,16-1	10,16	20.580	21.580	0,9970 \$	100
MBDK-PY	2.54 mm ARA PLAKA	20.620	21.620	0,0997 \$	100

3.81 x 12.7 x 15.24 mm GÜÇ KLEMENSİ



KOD	SİPARİŞ NO		AD. / \$	K. AD.
BDGK-433	20.660	21.660	4,3795 \$	10

KART YUVASI SERİSİ

72 mm MODÜL



PİN	KOD	SİPARİŞ NO	AD. / \$	K. AD.
2	KYS MM/ 72	51.050	0,4901 \$	50
3	KYS MK/ 72	51.075	0,2863 \$	50
4	KYS MA/ 72	51.100	0,3578 \$	50

72 mm PROFİL



KOD	ÜRÜN	SİPARİŞ NO	AD. / \$	K. AD.
KYS PP/72-1	PROFİL 1 mt	51.450	8,6672 \$	20
KYS PP/72-2	PROFİL 2 mt	51.475	17,3344 \$	20
KYS PK/72	KAPAK	51.500	0,3814 \$	50
KYS PA/73	AYAK	51.525	0,4949 \$	50

108 mm PROFİL

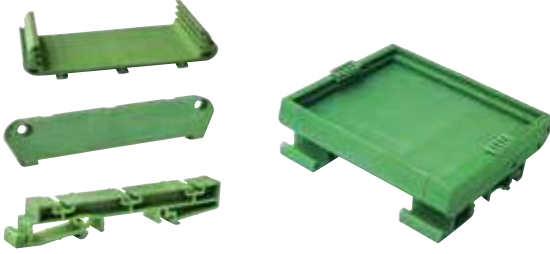

KOD	ÜRÜN	SİPARİŞ NO	AD. / \$	K. AD.
KYS PP/108-1	PROFİL 1 mt	51.750	10,1958 \$	20
KYS PP/108-2	PROFİL 2 mt	51.775	20,3916 \$	20
KYS PK/108	KAPAK	51.800	0,4570 \$	50
KYS PA/108	AYAK	51.825	0,6052 \$	50

DİSTANS SERİSİ (RAY DİSTANS)

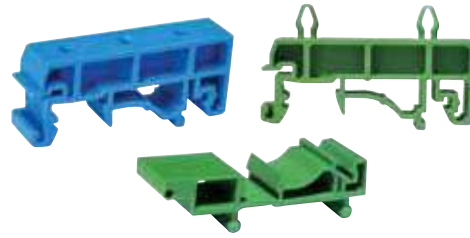

KOD	ÜRÜN	SİP.NO	AD. / \$	K. AD.
DIS RD/1	RAY DİSTANS VİDALI	61.300	0,2928 \$	100
DIS RD/0	RAY DİSTANS VİDASIZ	61.340	0,3226 \$	100
DIS SRD	SOĞUTUCU RAY DİSTANS	61.380	0,4128 \$	100

3.81 mm KABLO BİRLEŞTİRİCİ RAY DİSTANS



KOD	ÜRÜN	SİPARİŞ NO	AD. / \$	K.AD.
DIS 3,81/KB	3,81 mm KBRD+D	60.420 61.420	0,2745 \$	200

5.08 mm KABLO BİRLEŞTİRİCİ RAY DİSTANS

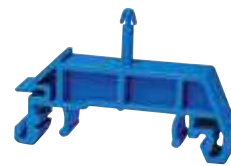

KOD	ÜRÜN	SİPARİŞ NO	AD. / \$	K.AD.
DIS 5,08/KB	5,08 mm KBRD+D	60.460 61.460	0,3158 \$	100

5,08 mm SOKET KABLO BİRLEŞTİRİCİ KATLI ERKEK



PİN	KOD	SİPARİŞ NO		AD. / \$	K. AD.
2	SKBKE 5,08-KB/2x2	10.652	11.652	0,6414 \$	50
3	SKBKE 5,08-KB/2x3	10.653	11.653	0,9621 \$	50
4	SKB KE 5,08-KB/2x4	10.654	11.654	1,2828 \$	40
5	SKBKE 5,08-KB/2x5	10.655	11.655	1,6035 \$	40
6	SKBKE 5,08-KB/2x6	10.656	11.656	1,9242 \$	40
7	SKBKE 5,08-KB/2x7	10.657	11.657	2,2449 \$	25
8	SKBKE 5,08-KB/2x8	10.658	11.658	2,5656 \$	25
9	SKBKE 5,08-KB/2x9	10.659	11.659	2,8863 \$	25
10	SKBKE 5,08-KB/2x10	10.660	11.660	3,2070 \$	20
11	SKBKE 5,08-KB/2x11	10.661	11.661	3,5277 \$	20
12	SKBKE 5,08-KB/2x12	10.662	11.662	3,8484 \$	20

5,08 mm RAY TİPİ SOKET KLEMENS



PİN	KOD	SİPARİŞ NO		AD. / \$	K. AD.
2	RTKSK 5,08-KB/2x2	10.672	11.672	1,8930 \$	50
3	RTKSK 5,08-KB/2x3	10.673	11.673	2,8935 \$	50
4	RTKSK 5,08-KB/2x4	10.674	11.674	3,7860 \$	40
5	RTKSK 5,08-KB/2x5	10.675	11.675	4,7325 \$	40
6	RTKSK 5,08-KB/2x6	10.676	11.676	5,6790 \$	40
7	RTKSK 5,08-KB/2x7	10.677	11.677	6,6255 \$	25
8	RTKSK 5,08-KB/2x8	10.678	11.678	7,5720 \$	25
9	RTKSK 5,08-KB/2x9	10.679	11.679	8,5185 \$	25
10	RTKSK 5,08-KB/2x10	10.680	11.680	9,4650 \$	20
11	RTKSK 5,08-KB/2x11	10.681	11.681	10,4115 \$	20
12	RTKSK 5,08-KB/2x12	10.682	11.682	11,3580 \$	20

SMD KLEMENS SERİSİ



KOD	ÜRÜN	SİPARİŞ NO	AD. / \$	K. AD.
SMD Y/0	YAYSIZ	49.000	0,2270 \$	1000
SMD Y/1	YAYLI TEK	49.100	0,1398 \$	1000
SMD Y/2	YAYLI ÇİFT	49.130	0,2098 \$	1000
SMD Y/T0	YAYSIZ (TÜPLÜ)	49.180	0,2573 \$	60
SMD Y/T1	YAYLI TEKLİ (TÜPLÜ)	49.230	0,1522 \$	108
SMD Y/T2	YAYLI ÇİFT (TÜPLÜ)	49.280	0,2283 \$	60

SİGORTA YUVASI

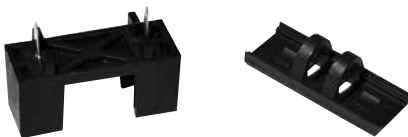

KOD	ÜRÜN	SİP. NO	AD. / \$	K. AD.
SKAP	SİGORTA KAPAĞI	83.050	0,0333 \$	500
SYUV	SİGORTA YUVASI	83.075	0,1094 \$	500

2x20 Metre

Toplam Şerit Uzunluğu 40 metre

40 metrelik şerit ile yaklaşık:
7.500 adet 1,5 mm² lik,
6.500 adet 2,5 mm² lik,
5.500 adet 4 mm² lik,
4.500 adet 6 mm² lik,
4.000 adet 10 mm² lik
klemens etiketlenebilmektedir.



Isı büzüsmeli makarona baskı



ONKA-8912-AX



ONKA-8944-35



ONKA-8944-110



ONKA-8943-S11

KOD	AÇIKLAMA	ADET (€)	K.AD.
ONKA-8912-AX	CP2140 Termal Yazıcı	1	1
ONKA-8944-35	35 mm x 300 mt Siyah Ribon	41,23 €	1
ONKA-8944-110	110 mm x 300 mt Siyah Ribon	99,75 €	1
ONKA-8943-S11	11 mm x 2 x 20 (40 mt) Duple Şerit Etiket	14,00 €	1

ÖRNEK KOD AÇILIMI

ONKA - 8923 - 1545 0 G

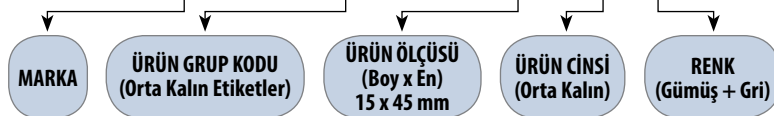

KOMPONENT ETİKETLERİ (8920)

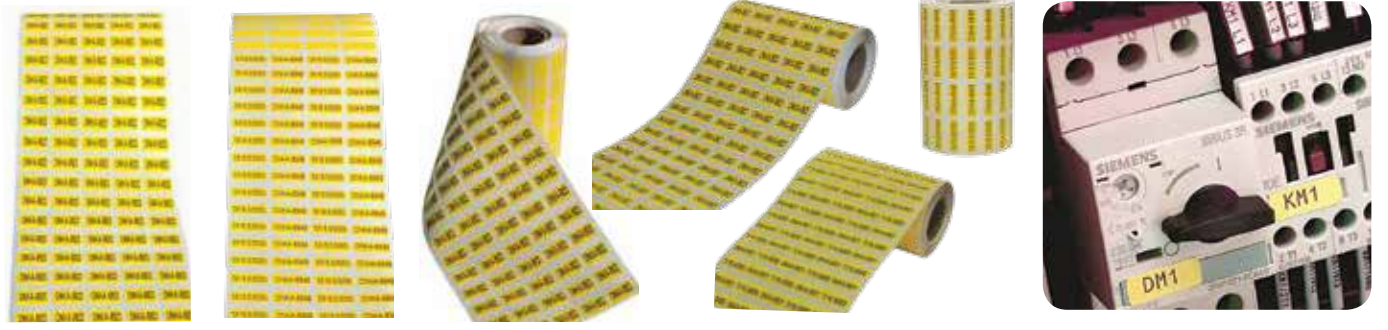

KOD	AÇIKLAMA	ADET €	K.AD.
ONKA-8920-515B	5x15 mm Beyaz Komponent Etiketi	€	5000
ONKA-8920-915SV	9x15 mm Sarı Komponent Etiketi	€	5000
ONKA-8920-9155BR	9x15 mm Sarı Komponent Etiketi	€	5000
ONKA-8920-716S	7x16 mm Sarı Komponent Etiketi	€	5000
ONKA-8920-9155E	9x15 mm Sarı Komponent Etiketi (Eko)	€	5000
ONKA-8920-516S	5x16,5 mm Sarı Komponent Etiketi	€	5000
ONKA-8920-930S	9x30 mm Sarı Komponent Etiketi	€	1500
ONKA-8920-2015S	20 mm x 15 mt Sarı Genel Amaçlı Şerit Etiket	€	15

İNCE PANO ETİKETLERİ (8921)



KOD	AÇIKLAMA	ADET €	RULO AD.
ONKA-8921-80100SW	80X100 mm Silwermat İnce Pano Etiketi (EKO)		100 ADET
ONKA-8921-5075SW	50X75 mm Silwermat İnce Pano Etiketi (EKO)		1000 ADET
ONKA-8921-2575SW	25X75 mm Silwermat İnce Pano Etiketi (EKO)		2000 ADET
ONKA-8921-1326SW	13X26 mm Silwermat İnce Pano Etiketi (EKO)		1500 ADET
ONKA-8921-40100SW	40X100 mm Silwermat İnce Pano Etiketi (EKO)		500 ADET
ONKA-8921-1545SW	15X45 mm Silwermat İnce Pano Etiketi (EKO)		1000 ADET
ONKA-8921-1527SW	15X27 mm Silwermat İnce Pano Etiketi (EKO)		1000 ADET

KALIN PANO ETİKETLERİ (8922)

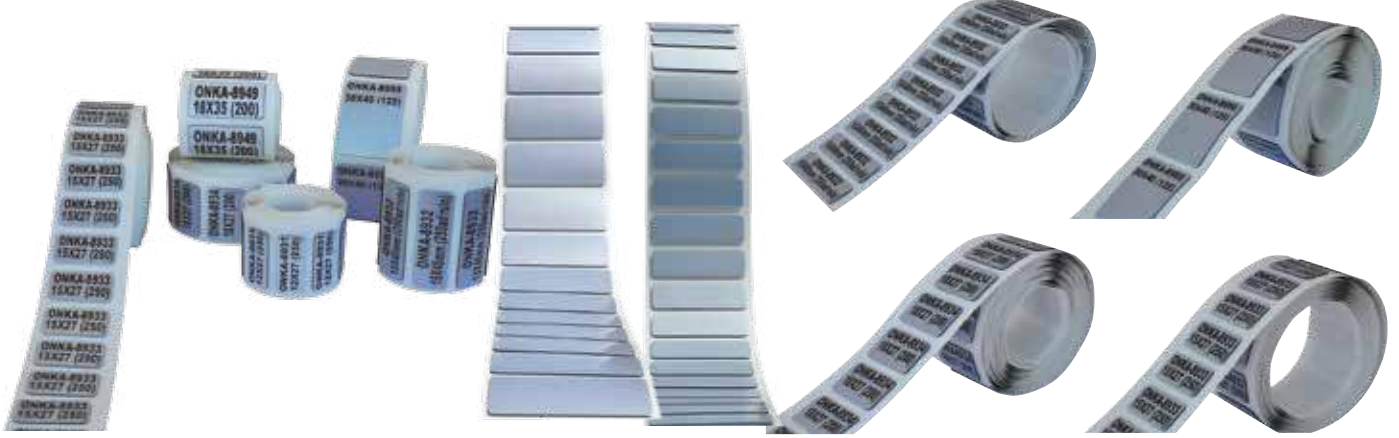

KOD	AÇIKLAMA	ADET €	K.AD.
ONKA-8922-1227P	12,5x27 mm Gri Kalın Pano Etiketi	€	200
ONKA-8922-1545P	15x45 mm Gri Kalın Pano Etiketi	€	125
ONKA-8922-1527P	15x27 mm Gri Kalın Pano Etiketi	€	150
ONKA-8922-1827P	18x27 mm Gri Kalın Pano Etiketi	€	150
ONKA-8922-1835P	18x35 mm Gri Kalın Pano Etiketi	€	125
ONKA-8922-3040P	30x40 mm Gri Kalın Pano Etiketi (Buton)	€	100
ONKA-8922-3060P	30x60 mm Gri Kalın Pano Etiketi	€	125
ONKA-8922-4590P	45x90 mm Gri Kalın Pano Etiketi	€	100



ORTA KALIN PANO ETİKETLERİ (8923)

KOD	AÇIKLAMA	ADETADET €	K.AD. (mt)
ONKA-8923-15450G	15x45 mm Kalın Pano Etiketi (Gümüş)		1000
ONKA-8923-15270G	15x27 mm Kalın Pano Etiketi (Gümüş)		1500
ONKA-8923-501000G	50x100 mm Kalın Pano Etiketi (Gümüş)		250
ONKA-8923-30650G	30x65 mm Kalın Pano Etiketi (Gümüş)		500
ONKA-8923-15450B	15x45 mm Kalın Pano Etiketi (Beyaz)		500
ONKA-8923-15450K	15x45 mm Kalın Pano Etiketi (Kırmızı)		500
ONKA-8923-15270B	15x27 mm Kalın Pano Etiketi (Beyaz)		500
ONKA-8923-15270K	15x27 mm Kalın Pano Etiketi (Kırmızı)		750
ONKA-8923-30650K	30x65 mm Kalın Pano Etiketi (Kırmızı)		250

ŞEFFAF TÜP - KABLO ETİKETLEME ÇÖZÜMLERİ (-8926)

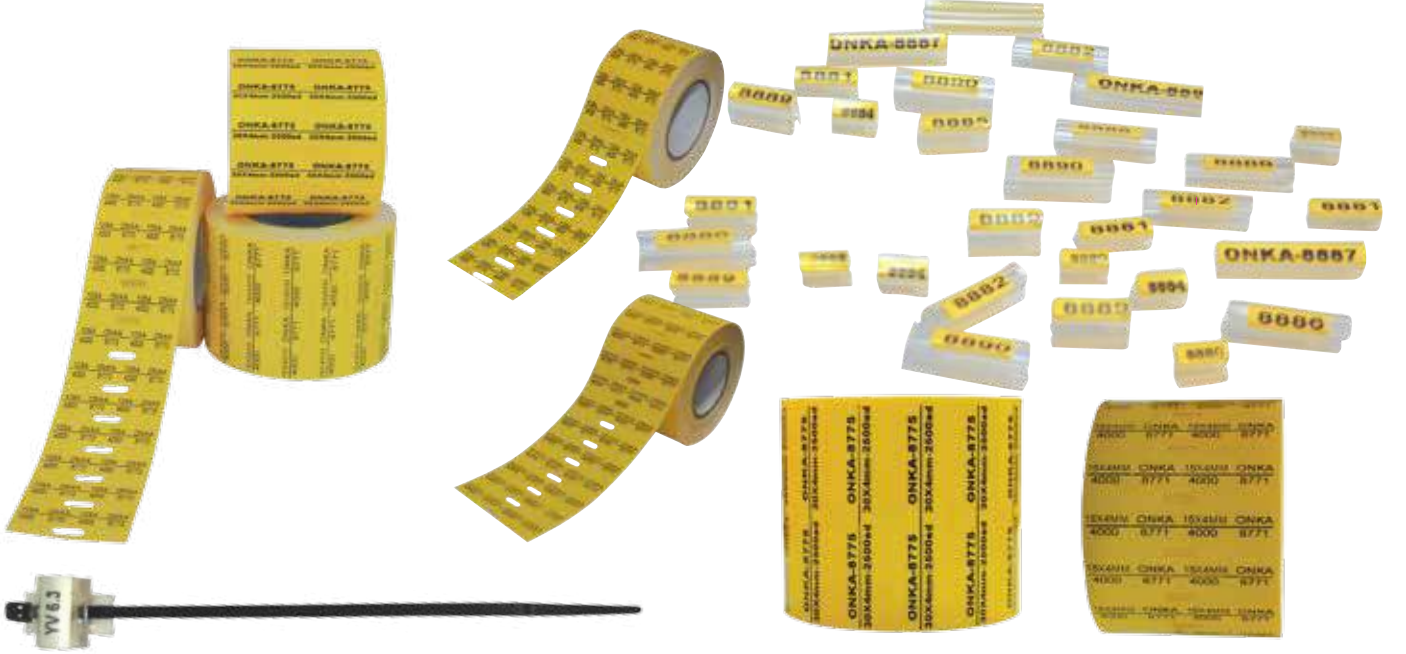

KOD	AÇIKLAMA	ADET €	K.AD.
ONKA-8925-104B	10x4 mm Şeffaf Tüp Etiketi (Beyaz)		4000
ONKA-8925-154B	15x4 mm Şeffaf Tüp Etiketi (Beyaz)		4000
ONKA-8925-204B	20x4 mm Şeffaf Tüp Etiketi (Beyaz)		3000
ONKA-8925-304B	30x4 mm Şeffaf Tüp Etiketi (Beyaz)		2500
ONKA-8925-104S	10x4 mm Şeffaf Tüp Etiketi (Sarı)		4000
ONKA-8925-154S	15x4 mm Şeffaf Tüp Etiketi (Sarı)		4000
ONKA-8925-204S	20x4 mm Şeffaf Tüp Etiketi (Sarı)		3000
ONKA-8925-304S	30x4 mm Şeffaf Tüp Etiketi (Sarı)		2500
ONKA-8926-101	10 mm Şeffaf Tüp / 0,5-1,5 mm ² Kablo İçin		1000
ONKA-8926-151	15 mm Şeffaf Tüp / 0,5-1,5 mm ² Kablo İçin		1000
ONKA-8926-201	20 mm Şeffaf Tüp - 0,5-1,5 mm ² Kablo İçin		500
ONKA-8926-301	30 mm Şeffaf Tüp - 0,5-1,5 mm ² Kablo İçin		500
ONKA-8926-102	10 mm Şeffaf Tüp / 2,5-4 mm ² Kablo İçin		1000
ONKA-8926-152	15 mm Şeffaf Tüp / 2,5-4 mm ² Kablo İçin		1000
ONKA-8926-202	20 mm Şeffaf Tüp / 2,5-4 mm ² Kablo İçin		500
ONKA-8926-302	30 mm Şeffaf Tüp / 2,5-4 mm ² Kablo İçin		500
ONKA-8926-103	10 mm Şeffaf Tüp / 4-6 mm ² Kablo İçin		1000
ONKA-8926-153	15 mm Şeffaf Tüp / 4-6 mm ² Kablo İçin		1000
ONKA-8926-203	20 mm Şeffaf Tüp / 4-6 mm ² Kablo İçin		500
ONKA-8926-303	30 mm Şeffaf Tüp / 4-6 mm ² Kablo İçin		500
ONKA-8926-420	20x4 mm Şeffaf Tüp / Kablo Bağı (Genel Amaçlı)		1000

KABLOLAMA ÇÖZÜMLERİ



KOD	AÇIKLAMA	ADET €	K.AD.
ONKA-8924-1910B	19X10 mm (1.5-2.5-4-6-10 mm ²) Sarmal Kablo Etiketi (Beyaz)		1000
ONKA-8924-1915B	19X15 mm (1.5-2.5-4-6 mm ²) Sarmal Kablo Etiketi (Beyaz)		2000
ONKA-8924-1925B	19X25 mm (10-16 mm ²) Sarmal Kablo Etiketi (Beyaz)		1500
ONKA-8924-1938B	19X38 mm (25-35-50 mm ²) Sarmal Kablo Etiketi (Beyaz)		2000
ONKA-8924-1915S	19X15 mm (1.5-2.5-4-6 mm ²) Sarmal Kablo Etiketi (Sarı)		2000
ONKA-8924-1925S	19X25 mm (10 -16 mm ²) Sarmal Kablo Etiketi (Sarı)		1500
ONKA-8924-1938S	19X38 mm (25-35-50 mm ²) Sarmal Kablo Etiketi (Sarı)		2000
ONKA-8924-38180S	38X180 mm Sarmal Kablo Etiketi (Sarı)		720

BASKILI DEKAFİX MARKALAMA SİSTEMİ (KLEMENSLER İÇİN)



KULLAN AT KALEM



DOLDURULABİLİR KALEM



POLİOLEFİN MALZEMEDEN İMAL 2/1 ORANINDA DARALAN UL ww-1 SERTİFİKALI RoHS, ISO BELGELİ 600 V ÇALIŞMA SICAKLIĞI -55 °C + 125 °C



Ölçüler		Daralmadan Önce (mm)		Daralmadan Sonra (mm)		Makara (m)	Metre Fiyatı \$
Inc (Ø)	mm	İç Çap	Cidar Kalınlığı	İç Çap	Cidar Kalınlığı		
3 / 64	0.8	1,1 ± 0,2	0,15 ± 0,05	0,40	0,28 ± 0,10	200	0,130 \$
	1	1,5 ± 0,2	0,15 ± 0,05	0,50	0,28 ± 0,10	200	0,065 \$
	1.2	2,0 ± 0,2	0,15 ± 0,05	0,70	0,30 ± 0,10	200	0,065 \$
1 / 16	1.5	2,0 ± 0,2	0,18 ± 0,05	0,85	0,32 ± 0,10	200	0,068 \$
	1.6	2,0 ± 0,3	0,15 ± 0,05	0,80	0,28 ± 0,10	200	0,068 \$
	2	2,5 ± 0,2	0,18 ± 0,05	0,60	0,28 ± 0,10	200	0,074 \$
3 / 32	2.4	3,0 ± 0,3	0,18 ± 0,05	1,20	0,35 ± 0,10	200	0,074 \$
	2.5	3,0 ± 0,2	0,18 ± 0,05	1,30	0,38 ± 0,10	200	0,096 \$
	3	3,5 ± 0,2	0,18 ± 0,05	1,50	0,40 ± 0,10	200	0,102 \$
1 / 8	3.2	3,5 ± 0,4	0,18 ± 0,05	1,60	0,40 ± 0,10	200	0,102 \$
	3.5	4,0 ± 0,2	0,22 ± 0,05	1,80	0,42 ± 0,10	200	0,110 \$
	4	4,5 ± 0,2	0,25 ± 0,05	2,00	0,45 ± 0,10	200	0,130 \$
3 / 16	4.5	5,0 ± 0,2	0,25 ± 0,05	2,30	0,50 ± 0,10	100	0,150 \$
	4.8	5,2 ± 0,4	0,25 ± 0,05	2,40	0,50 ± 0,10	100	0,150 \$
	5	5,5 ± 0,2	0,25 ± 0,05	2,50	0,55 ± 0,10	100	0,160 \$
1 / 4	6	6,5 ± 0,2	0,28 ± 0,05	3,00	0,55 ± 0,10	100	0,180 \$
	6.4	7,0 ± 0,4	0,28 ± 0,05	3,20	0,55 ± 0,10	100	0,180 \$
	7	7,5 ± 0,3	0,28 ± 0,05	3,50	0,55 ± 0,10	100	0,230 \$
3 / 8	8	8,5 ± 0,3	0,28 ± 0,05	4,00	0,60 ± 0,10	100	0,250 \$
	9	9,5 ± 0,3	0,30 ± 0,08	4,50	0,60 ± 0,10	50	0,280 \$
	9.5	10,0 ± 0,5	0,30 ± 0,08	4,80	0,60 ± 0,10	100	0,235 \$
1 / 2	10	10,5 ± 0,3	0,30 ± 0,08	5,00	0,60 ± 0,10	100	0,260 \$
	11	11,5 ± 0,3	0,30 ± 0,08	5,50	0,60 ± 0,10	100	0,280 \$
	12	12,5 ± 0,3	0,30 ± 0,08	6,00	0,60 ± 0,10	100	0,290 \$
3 / 4	12.7	13,0 ± 0,5	0,30 ± 0,08	6,40	0,60 ± 0,10	100	0,290 \$
	13	13,5 ± 0,3	0,35 ± 0,10	6,50	0,65 ± 0,10	100	0,310 \$
	14	14,5 ± 0,3	0,35 ± 0,10	7,00	0,65 ± 0,10	100	0,380 \$
4 / 5	15	15,5 ± 0,3	0,35 ± 0,10	7,00	0,65 ± 0,10	100	0,440 \$
	16	16,5 ± 0,4	0,40 ± 0,12	8,00	0,70 ± 0,10	100	0,500 \$
	17	17,5 ± 0,4	0,40 ± 0,12	8,50	0,70 ± 0,10	100	0,650 \$
1	18	19,0 ± 0,5	0,40 ± 0,15	9,00	0,80 ± 0,15	100	0,660 \$
	19.1	20,5 ± 0,6	0,40 ± 0,15	9,50	0,80 ± 0,15	100	0,660 \$
	20	21,0 ± 0,6	0,40 ± 0,15	10,00	0,80 ± 0,15	100	0,810 \$
1 - 1 / 4	22	23,0 ± 0,5	0,40 ± 0,15	11,00	0,80 ± 0,15	100	0,980 \$
	25.4	25,6 ± 0,7	0,50 ± 0,15	12,70	0,80 ± 0,15	50	1,100 \$
	30	31,5 ± 1,0	0,50 ± 0,15	15,00	0,90 ± 0,15	50	1,400 \$
1 - 1 / 2	32	33,0 ± 0,7	0,50 ± 0,15	15,90	0,95 ± 0,15	50	1,400 \$
	35	36,5 ± 1,0	0,50 ± 0,15	17,50	0,95 ± 0,15	50	1,950 \$
	38	40,0 ± 0,7	0,50 ± 0,15	19,10	1,00 ± 0,15	50	2,120 \$
2	40	41,5 ± 1,0	0,55 ± 0,15	20,00	1,00 ± 0,15	50	2,120 \$
	51	52,5 ± 0,7	0,55 ± 0,15	25,40	0,95 ± 0,15	25	2,900 \$
	60	60	0,60 ± 0,15	30,00	1,30 ± 0,20	25	4,000 \$
3	70	70	0,65 ± 0,15	35,00	1,30 ± 0,20	25	5,200 \$
	76	80,0 ± 1,0	0,65 ± 0,15	38,10	1,30 ± 0,20	25	5,900 \$
	80	80	0,65 ± 0,15	40,00	1,46 ± 0,20	25	6,000 \$
4	90	90	0,65 ± 0,15	45,00	1,46 ± 0,20	25	6,300 \$
	102	105,0 ± 1,0	0,65 ± 0,20	50,80	1,46 ± 0,20	25	7,400 \$
	150	150	0,65 ± 0,20	75,00	1,56 ± 0,20	25	16,000 \$
5	120	120	0,65 ± 0,20	63,50	1,56 ± 0,20	25	10,500 \$
	180	180	0,65 ± 0,30	90,00	1,56 ± 0,20	25	22,000 \$

ISI BÜZÜŞMELİ MAKARON VE BASKI TEKNİKLERİ



Renkler	Inc	mm	Makara (m)	Metre Fiyatı \$
Şeffaf	1/16	1,6	200	0,085 \$
		2,0	200	0,100 \$
	3/32	2,4	200	0,100 \$
		2,5	200	0,130 \$
	1/8	3,2	200	0,150 \$
		3,5	200	0,160 \$
Beyaz	3/16	4,8	100	0,180 \$
	5	100	0,200 \$	
Sarı	1/4	6,4	100	0,220 \$
	3/8	9,5	100	0,270 \$
Mavi	1/2	12,7	100	0,340 \$
		16	100	0,650 \$
Kırmızı	3/4	19,1	100	0,950 \$
	4/5	20	100	1,150 \$
Yeşil	1	25,4	50	1,400 \$
	1-1/4	32	50	1,900 \$
Gri		35	50	2,700 \$
	1-1/2	38	50	2,900 \$
	2	51	50	3,350 \$
		60	25	5,200 \$
		70	25	6,000 \$
	3	76	25	6,400 \$
	80	25	6,500 \$	
	4	102	25	8,800 \$
	5	120	25	15,000 \$

Kahverengi Metre Fiyatı \$	Sarı - Yeşil Metre Fiyatı \$
-	-
-	-
0,130 \$	0,320 \$
0,140 \$	0,320 \$
0,170 \$	0,330 \$
-	-
0,230 \$	0,340 \$
-	-
0,300 \$	0,390 \$
0,350 \$	0,540 \$
0,450 \$	0,670 \$
0,900 \$	1,100 \$
1,100 \$	1,280 \$
1,150 \$	1,350 \$
1,550 \$	2,000 \$
2,100 \$	2,650 \$
3,200 \$	3,500 \$
3,400 \$	3,600 \$
3,800 \$	5,500 \$
5,900 \$	7,300 \$
7,300 \$	-
7,900 \$	12,000 \$
8,000 \$	12,000 \$
10,800 \$	18,000 \$
16,000 \$	-

3/1 İÇİ YAPIŞKANLI DARALAN MAKARON



Ölçü (mm)	Daralmadan Önce (mm)		Yapışkan Katmanı	Daralmadan Sonra (mm)		Makara (m)	Metre Fiyatı \$
	İç Çap (mm)	Cidar Kalınlığı		İç Çap (mm)	Cidar Kalınlığı		
3.2	3	0,95 ± 0,10	0,35	1,00 ± %10	0,95 ± 0,10	200 m	0,65 \$
4.8	4.8	1,10 ± 0,10	0,40	1,60 ± %10	1,10 ± 0,10	100 m	0,80 \$
6.4	6.2	1,20 ± 0,10	0,45	2,00 ± %10	1,20 ± 0,10	100 m	0,95 \$
9.5	9.5	1,45 ± 0,10	0,50	3,15 ± %10	1,45 ± 0,25	50 m	1,30 \$
12.7	12.5	1,60 ± 0,20	0,50	4,16 ± %10	2,45 ± 0,25	1.22 Boy	2,80 \$
16	16	1,45 ± 0,20	0,35	5,30 ± %10	1,75 ± 0,25	1.22 Boy	3,00 \$
19.1	19	1,50 ± 0,20	0,40	6,30 ± %10	1,90 ± 0,25	1.22 Boy	3,90 \$
25.4	25	2,00 ± 0,20	0,45	8,50 ± %10	1,45 ± 0,25	1.22 Boy	4,00 \$
28	28	2,00 ± 0,20	0,50	9,00 ± %10	2,70 ± 0,25	1.22 Boy	4,30 \$
30	30	2,00 ± 0,20	0,50	10,0 ± %10	2,70 ± 0,25	1.22 Boy	4,75 \$
33	33	2,20 ± 0,20	0,50	11,0 ± %10	2,70 ± 0,25	1.22 Boy	5,00 \$
40	40	2,20 ± 0,20	0,50	13,30 ± %10	2,70 ± 0,25	1.22 Boy	6,00 \$
44	44	2,30 ± 0,25	0,50	16,60 ± %10	2,80 ± 0,30	1.22 Boy	6,80 \$
52	52	2,30 ± 0,25	0,50	18,00 ± %10	2,80 ± 0,30	1.22 Boy	7,60 \$
70	70	2,60 ± 0,25	0,50	24,00 ± %10	3,00 ± 0,30	1.22 Boy	10,00 \$
90	90	3,10 ± 0,30	0,60	30,00 ± %10	3,70 ± 0,35	1.22 Boy	15,00 \$
125	125	3,15 ± 0,30	0,60	42,00 ± %10	3,75 ± 0,35	1.22 Boy	20,00 \$

2 KV CAM - ELYAF MAKARONLAR (BEYAZ ÜZERİ ÇİZGİLİ - SİYAH)



KOD	Çap (mm)	Rulo (m)	Metre Fiyatı \$
FG-VG 0.70	0.70	100	0,087 \$
FG-VG 1.00	1.00	100	0,087 \$
FG-VG 1.50	1.50	100	0,111 \$
FG-VG 2.00	2.00	100	0,126 \$
FG-VG 2.50	2.50	100	0,141 \$
FG-VG 3.00	3.00	100	0,180 \$
FG-VG 3.50	3.50	100	0,192 \$
FG-VG 4.00	4.00	100	0,225 \$
FG-VG 5,00	5,00	100	0,398 \$
FG-VG 6.00	6.00	50	0,426 \$
FG-VG 7.00	7.00	50	0,518 \$
FG-VG 8.00	8.00	50	0,561 \$
FG-VG 10.00	10.00	50	0,803 \$
FG-VG 12.00	12.00	50	1,013 \$
FG-VG 14.00	14.00	50	1,283 \$
FG-VG 16.00	16.00	50	2,100 \$
FG-VG 18.00	18.00	50	2,130 \$
FG-VG 20.00	20.00	25	2,625 \$
FG-VG 25.00	25.00	25	6,750 \$



İzolasyon Sınıfı : 8 Çalışma Sıcaklığı : -25 °C / 130 °C

6 KV H KLAS CAM + SİLİKON İZOLELİ MAKARONLAR (KIRMIZI - SİYAH)



KOD	Çap (mm)	Rulo (m)	Metre Fiyatı \$
FG-SRG 0.70	0.70	100	0,315 \$
FG-SRG 1.00	1.00	100	0,315 \$
FG-SRG 1.50	1.50	100	0,345 \$
FG-SRG 2.00	2.00	100	0,375 \$
FG-SRG 2.50	2.50	100	0,450 \$
FG-SRG 3.00	3.00	100	0,660 \$
FG-SRG 3.50	3.50	100	0,750 \$
FG-SRG 4.00	4.00	100	0,825 \$
FG-SRG 5,00	5,00	100	0,938 \$
FG-SRG 6.00	6.00	100	1,125 \$
FG-SRG 7.00	7.00	100	1,500 \$
FG-SRG 8.00	8.00	100	1,725 \$
FG-SRG 10.00	10.00	100	2,235 \$
FG-SRG 12.00	12.00	50	3,000 \$
FG-SRG 14.00	14.00	50	4,125 \$
FG-SRG 16.00	16.00	50	4,875 \$
FG-SRG 18.00	18.00	50	5,813 \$
FG-SRG 20.00	20.00	25	7,463 \$
FG-SRG 25.00	25.00	25	13,088 \$



İzolasyon Sınıfı: H Class Çalışma Sıcaklığı : -60 °C / 230 °C

KABLO TOPLAMA ÇORABI



KOD	Min. Tutma Çapı	Max. Tutma Çapı	Rulo (m)	Renk	Metre Fiyatı \$	Renkli Metre Fiyatı \$
PE - HB 3 - 8	3	8	100	● ●	0,330 \$	● ● ● 0,413 \$
PE - HB 5 - 10	5	10	100	● ●	0,330 \$	● ● ● 0,413 \$
PE - HB 6 - 11	6	11	100	● ●	0,390 \$	● ● ● 0,488 \$
PE - HB 8 - 12	8	12	100	● ●	0,540 \$	● ● ● 0,675 \$
PE - HB 10 - 15	10	15	100	● ●	0,600 \$	● ● ● 0,750 \$
PE - HB 12 - 19	12	19	100	● ●	0,750 \$	● ● ● 0,938 \$
PE - HB 15 - 27	15	27	100	● ●	0,810 \$	● ● ● 1,013 \$
PE - HB 20 - 28	20	28	100	● ●	1,080 \$	● ● ● 1,350 \$
PE - HB 25 - 34	25	34	100	● ●	1,350 \$	● ● ● 1,688 \$
PE - HB 30 - 37	30	37	100	● ●	1,800 \$	● ● ● 2,250 \$
PE - HB 40 - 45	40	45	100	● ●	2,400 \$	● ● ● 3,000 \$
PH - HB 50 - 65	50	65	100	● ●	3,150 \$	● ● ● 3,938 \$

HELEZON PANO SİRALLERİ



KOD	İÇ ÇAP (mm)	DIŞ ÇAP (mm)	MT. / ʘ	MT.
EMTİ - TSPR6	4.1	6.2	0,93	10
EMTİ - TSPR8	6.0	8.0	1,20	10
EMTİ - TSPR10	7.5	10.0	1,90	10
EMTİ - TSPR12	9.0	12.0	2,70	10
EMTİ - TSPR15	12.0	15.0	3,45	10

KABLO TOPLAMA SİRALLERİ



KOD	EBAT	M. / ʘ	MT.
EMTİ - TTSPR8	8 mm Siyah	5,25	5
EMTİ - TTSPR15	15 mm Siyah	6,96	5
EMTİ - TTSPR20	20 mm Siyah	10,50	5
EMTİ - TTSPR 25	25 mm Siyah	16,50	5
EMTİ - TTSPR32	32 mm Siyah	27,00	5

BANT ÇEŞİTLERİ

İZOLE BANT ÇEŞİTLERİ



KOD	KESİT	RENK	AD. / \$
GL-001	15 mm x 10 yrd.	Karışık Renkli	
GL-002	19 mm x 10 yrd	Karışık Renkli	
GL-003	50 mm x 25 yrd	Karışık Renkli	
YT-001	19 mm x 10 yrd	Siyah	
YT-002	30 mm x 25 mt	Siyah	
YT-003	50 mm x 25 mt	Siyah	☎
YT-004	19 mm x 25 mt	Siyah	
YT-005	19 mm x 10 yrd	Sarı - Yeşil	

ERİYEN BANTLAR (SCAPA)



KOD	KESİT	AD. / €
SCAP-2501	19 mm x 0.50 mm x 10 yrd	☎

ERİYEN BANTLAR (U. D.)



KOD	KESİT	AD. / \$
BANT-19	19 mm x 0,8 mm x 8 mt 6-10 kV	☎
BANT-50	50 mm x 0,8 mm x 8 mt 6-10 kV	

TEFLON BANTLAR



KOD	KESİT	AD. / ₺
TEFL - 001	12 mm x 0.076 mm 12 mm	☎

KOLİ BANTLARI



KOD	KESİT	AD. / ₺
KLB01	45 mm x 40 mt. Şef. Kah.	☎

ÇİFT TARAFLI BANTLAR



MONOFAZE 1 x 16 A KAPAKLI PANO PRİZLERİ



KOD	CİNSİ	AD. / ʘ	K. AD.
MPP-1	1 x 16 A Pano Priz (Mavi kapak)	ʘ	10

ELEKTRONİK PANO TERMOSTATI



KOD	CİNSİ	AD. / \$	K. AD.
PTS T/1	Elektronik Pano Termostatı Tek Yön	ʘ	1
PTS C/2	Elektronik Pano Termostatı Çift Yön Soğuk-Sıcak Ayarlı		1

PANO İÇİ ISITMA VE SOĞUTMA TERMOSTATLARI



KOD	CİNSİ	AD. / €	K. AD.
PTHT	Pano İçi Isıtma Termostatı 0 - 60 C, NK, IP 20	ʘ	1
PTVT	Pano İçi Soğutma Termostatı 0 - 60 C, NA, IP 20		1
PTVHT	Pano İçi Isıtma - Soğutma Termostatı 0 - 80 / 0-60 C, NK + NA, IP 20		1
PHG02	Mekanik Higrostat %10/90 RH, 1CO, IP 20		1

PANO ISITICILARI



KOD	CİNSİ	AD. / €	K. AD.
MPHT 015	15 WPTC Pano Isıtıcısı, Kablolu	ʘ	1
MPHT 025	25 WPTC Pano Isıtıcısı, Kablolu		1
PHT 030	30 WPTC Pano Isıtıcısı, Klemensli		1
PHT 050	50 WPTC Pano Isıtıcısı, Klemensli		1
PHT 075	75 WPTC Pano Isıtıcısı, Klemensli		1
PHT 100	100 WPTC Pano Isıtıcısı, Klemensli		1
PHT 150	150 WPTC Pano Isıtıcısı, Klemensli		1
PFHT 100	100 W Fanlı Rezitans Pano Isıtıcısı, Klemensli		1
PFHT 150	150 W Fanlı Rezitans Pano Isıtıcısı, Klemensli		1
PFHT 250	250 W Fanlı Rezitans Pano Isıtıcısı, Klemensli		1
PFHT 500	500 W Fanlı Rezitans Pano Isıtıcısı, Klemensli		1
PFHT 750	750 W Fanlı Rezitans Pano Isıtıcısı, Klemensli		1

HAVALANDIRMA FİLTRELERİ ve PANJURLARI



KOD	AÇIKLAMA	K. AD.	AD. / ʘ
OSKA-701.V1.4	Havalandırma Filtresi 150 x 150 RAL 7032	50	ʘ
OSKA-701.V1.5	Havalandırma Filtresi 150 x 150 RAL 7035	50	
OSKA-701.V1.6	Havalandırma Filtresi 150 x 150 RAL 9005 Siyah	50	
OSKA-701.V2.4	Havalandırma Filtresi 105 x 105 RAL 7032	50	
OSKA-701.V2.5	Havalandırma Filtresi 105 x 105 RAL 7035	50	
OSKA-701-2.4	Havalandırma Filtresi 250 x 250 RAL 7032	36	
OSKA-701-2.5	Havalandırma Filtresi 250 x 250 RAL 7035	36	
OSKA-701-2.6	Havalandırma Filtresi 250 x 250 RAL 9005 Siyah	36	
OSKA-726.4	Plastik Panjur RAL 7032	100	
OSKA-726.5	Plastik Panjur RAL 7035	100	
OSKA-726.6	Plastik Panjur RAL 9005 Siyah	100	

ENDÜSTRİYEL FANLAR



KOD	KARE FAN ÖLÇÜLERİ (En x Boy x Derinlik)	VOLT	AD. / \$
BRZ 01	120 x 120 x 25 Kablolu	220 VAC	☎
BRZ 02	120 x 120 x 38 Kablolu	220 VAC	
BRZ 03	120 x 120 x 25 Soketli	220 VAC	
BRZ 04	120 x 120 x 25 Kablolu	12 VDC	
BRZ 05	120 x 120 x 25 Kablolu	24 VDC	
BRZ 06	120 x 120 x 38 Kablolu	12 VDC	
BRZ 07	120 x 120 x 38 Kablolu	24 VDC	
BRZ 08	120 x 120 x 38 Kablolu	110 VAC	
BRZ 09	120 x 120 x 38 Kablolu	48 VDC	
BRZ 10	90 x 90 x 25 Kablolu	220 VAC	
BRZ 11	90 x 90 x 38 Kablolu	220 VAC	
BRZ 12	90 x 90 x 25 Kablolu	12 VDC	
BRZ 13	90 x 90 x 25 Kablolu	24 VDC	
BRZ 14	80 x 80 x 38 Kablolu	220 VAC	
BRZ 15	80 x 80 x 25 Kablolu	220 VAC	
BRZ 16	80 x 80 x 25 Kablolu	12 VDC	
BRZ 17	80 x 80 x 25 Kablolu	24 VDC	
BRZ 18	60 x 60 x 20 Kablolu	24 VDC	
BRZ 19	50 x 50 x 10 Kablolu	24 VDC	
BRZ 20	40 x 40 x 10 Kablolu	24 VDC	



KOD	YUVARLAK KÖŞELİ FAN ÖLÇÜLERİ (En x Boy x Derinlik)	VOLT	AD. / \$
BRZ 21	172 x 150 x 51	220 VAC - 255 m ³ /h	☎
BRZ 22	172 x 150 x 51	24 VDC	
BRZ 23	172 x 150 x 51	115 VAC	



KOD	YUVARLAK FAN ÖLÇÜLERİ (En x Boy x Derinlik)	VOLT	AD. / \$
BRZ 24	Ø220 x 60	220 VAC	☎

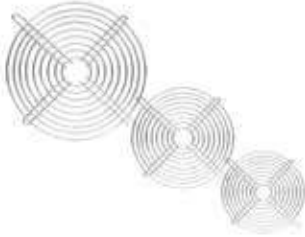

Metal Koruma Telleri

KOD	ÖLÇÜLER (En x Boy x Derinlik)	AD. / \$
TEL 01	80 x 80	☎
TEL 02	90 x 90	
TEL 03	120 x 120	
TEL 04	170 x 170	
TEL 05	225 x 225	
TEL 06	280 x 280	

PROJE CEPLERİ



KOD	çİNSİ	K. AD.	AD. / ₺
OSKA-226.4	Proje Cebi A-5-RAL 7032	150	☎
OSKA-226.5	Proje Cebi A-5-RAL 7035	150	
OSKA-227.4	Proje Cebi A-4-RAL 7032	75	
OSKA-227.5	Proje Cebi A-4-RAL 7035	75	



3 KUTUPLU KONTAKTÖR - KUMANDA 220 V AC

KOD	GÜÇ / AKIM / Y.KONTAK	AD. / \$
XCN-35 091	4 kW, 9 A, 1NO	7,20 \$
XCN-35 092	4 kW, 9 A, 1NC	7,20 \$
XCN-35 121	5.5 kW, 12 A, 1NO	7,70 \$
XCN-35 122	5.5 kW, 12 A, 1NC	7,70 \$
XCN-35 181	7.5 kW, 18 A, 1NO	9,50 \$
XCN-35 182	7.5 kW, 18 A, 1NC	9,50 \$
XCN-35 251	11 kW, 25 A, 1NO	13,00 \$
XCN-35 252	11 kW, 25 A, 1NC	13,00 \$
XCN-35 321	15 kW, 32 A, 1NO	17,50 \$
XCN-35 322	15 kW, 32 A, 1NC	17,50 \$
XCN-35 381	18,5 kW, 38 A, 1NO	25,00 \$
XCN-35 382	18,5 kW, 38 A, 1NC	25,00 \$
XCN-35 405	18.5 kW, 40 A, 1NO + 1NC	32,00 \$
XCN-35 505	22 kW, 50 A, 1NO + 1NC	34,00 \$
XCN-35 655	30 kW, 65 A, 1NO + 1NC	36,00 \$
XCN-35 805	37 kW, 80 A, 1NO + 1NC	47,00 \$
XCN-35 955	45 kW, 95 A, 1NO + 1NC	52,00 \$



MOTOR KORUMA ŞALTERİ

KOD	AKIM / GÜÇ	AD. / \$
15 - 100 kA		
XMP-10 016	1 - 1.6 A, 0.55 kW	20,00 \$
XMP-10 025	1.6 - 2.5 A, 0.75 kW	20,00 \$
XMP-10 040	2.5 - 4A, 1.5 kW	20,00 \$
XMP-10 063	4 - 6.3 A, 2.2 kW	20,00 \$
XMP-10 100	6 - 10 A, 4 kW	20,00 \$
XMP-10 140	9 - 14A, 5.5 kW	20,00 \$
XMP-10 180	13 - 18 A, 7.5 kW	20,00 \$
XMP-10 230	17 - 23 A, 9 kW	20,00 \$
XMP-10 250	20 - 25 A, 11 kW	20,00 \$
XMP-10 320	24 - 32 A, 15 kW	20,00 \$
Yardımcı Donanım		
XMP-90 211	Üst Kontak, NO + NC	4,00 \$
XMP-91 211	Yan Kontak, NO + NC	5,00 \$



YARDIMCI KONTAK BLOĞU

KOD	MONTAJ / KONTAK	AD. / \$
XCN-39 211	Üst, 1NO + 1NC	2,50 \$
XCN-39 422	Üst, 2NO + 2NC	4,00 \$



KAÇAK AKIM KORUMA RÖLESİ

KOD	AKIM	AD. / \$
2 Kutuplu		
XLC-41 225	2 x 25A, 30 mA	13,00 \$
XLC-41 240	2 x 40A, 30 mA	13,20 \$
XLC-41 263	2 x 63A, 30 mA	13,50 \$
XLC-42 225	2 x 25A, 300 mA	13,00 \$
XLC-42 240	2 x 40A, 300 mA	13,20 \$
XLC-42 263	2 x 63A, 300 mA	13,50 \$
4 Kutuplu		
XLC-41 425	4 x 25 A, 30 mA	18,00 \$
XLC-41 440	4 x 40 A, 30 mA	18,50 \$
XLC-41 463	4 x 63 A, 30 mA	19,00 \$
XLC-42 425	4 x 25 A, 300 mA	18,00 \$
XLC-42 440	4 x 40 A, 300 mA	18,50 \$
XLC-42 463	4 x 63 A, 300 mA	19,00 \$



3 KUTUPLU MİNİ KONTAKTÖR

KOD	GÜÇ / AKIM / Y.KONTAK	AD. / \$
XCN-15 091	220 V AC, 4 kW, 9 A, 1NO	9,00 \$
XCN-15 092	220 V AC, 4 kW, 9 A, 1NC	9,00 \$
XCN-17 091	24 V AC, 4 kW, 9 A, 1NO	9,00 \$
XCN-17 092	24 V AC, 4 kW, 9 A, 1NC	9,00 \$



TERMİK RÖLE

KOD	AKIM	AD. / \$
Kontaktörü: 9-32A		
XTR-31 016	1 - 1.6 A	7,50 \$
XTR-31 025	1.6 - 2.5 A	7,50 \$
XTR-31 040	2.5 - 4 A	7,50 \$
XTR-31 060	4 - 6 A	7,50 \$
XTR-31 080	5.5 - 8 A	7,50 \$
XTR-31 100	7 - 10 A	7,50 \$
XTR-31 130	9 - 13 A	7,50 \$
XTR-31 180	12 - 18 A	7,50 \$
XTR-31 250	17 - 25 A	7,50 \$



TOGGLE SWITCH

KOD	AÇIKLAMA	AD. / \$
1 Kutup (Kalıcı)		
MTX-16 101	ON-OFF / 2 Pin	2,20 \$
MTX-16 102	ON-ON / 3 Pin	2,60 \$
MTX-16 103	ON-OFF-ON / 3 Pin	2,60 \$
1 Kutup (Yaylı)		
MTX-16 112	ON-(ON) / 3 Pin	3,00 \$
MTX-16 113	ON-OFF- (ON) / 3 Pin	3,00 \$
MTX-16 123	(ON)-OFF-(ON) / 3 Pin	3,00 \$
2 Kutup (Kalıcı)		
MTX-16 201	ON-OFF / 4 Pin	3,20 \$
MTX-16 202	ON-ON / 6 Pin	3,70 \$
MTX-16 203	ON-OFF-ON / 6 Pin	3,70 \$
2 Kutup (Yaylı)		
MTX-16 212	ON-(ON) / 6 Pin	5,00 \$
MTX-16 213	ON-OFF- (ON) / 6 Pin	5,00 \$
MTX-16 223	(ON)-OFF-(ON) / 6 Pin	5,00 \$
3 Kutup (Kalıcı)		
MTX-16 302	ON-ON / 9 Pin	10,00 \$
MTX-16 303	ON-OFF-ON / 9 Pin	10,00 \$
Toogle Başlığı		
MTX-90 000	Kauçuk	1,00 \$

JOYSTICK KUMANDA

KOD	AÇIKLAMA	AD. / \$
3A/250 V AC		
MB3-JA 120	2 Yönlü , Kalıcı	13,00 \$
MB3-JA 220	2 Yönlü , Yaylı	13,00 \$
MB3-JA 140	4 Yönlü , Kalıcı	16,00 \$
MB3-JA 240	4 Yönlü , Yaylı	16,00 \$

SAYICI

KOD	AÇIKLAMA	AD. / \$
Mekanik Sayıcı-Resetli-Kilitli, Montaj: 48x24mm		
MCN-11 605	220 VAC / 6 Hane	20,00 \$
MCN-11 607	24 VDC / 6 Hane	20,00 \$
Mekanik Sayıcı-Resetli-Kilitli, Montaj: 48x24mm		
MCN-12 605	220VAC / 6 Hane	20,00 \$
MCN-12 607	24 VDC / 6 Hane	20,00 \$
Dijital Sayıcı-Resetli, Montaj: 48x24mm		
MCN-22 605	220VAC / 6 Hane	28,00 \$
MCN-22 607	24 VDC / 6 Hane	28,00 \$
İş Güç Zaman Saati, 48x48mm		
MCN-48 825	220VAC / 7 Hane	12,00 \$

SİREN VE BUZZER

KOD	AÇIKLAMA	AD. / \$
Ø30 Buzzer Tek Ton		
MSS-31 024	24VAC/DC	8,50 \$
MSS-31 220	220VAC	8,50 \$
Ø30 Buzzer Çift Ton		
MSS-32 024	12-24VAC/DC	9,00 \$
MSS-32 220	220VAC	9,00 \$
Ø70 Elektronik Siren, Plastik Gövde		
MSS-74 012	12VDC	6,50 \$
MSS-74 024	24VDC	6,50 \$
MSS-74 110	110VAC	9,50 \$
MSS-74 220	220VAC	9,50 \$
Ø75 Motorlu Siren, Metal Gövde		
MSS-76 012	12VDC	11,00 \$
MSS-76 024	24VDC	11,00 \$
MSS-76 110	110VAC	11,00 \$
MSS-76 220	220VAC	11,00 \$
Ø130 Motorlu Siren, Metal Gövde		
MSS-99 012	12VDC	25,00 \$
MSS-99 024	24VDC	25,00 \$
MSS-99 110	110VAC	25,00 \$
MSS-99 220	220VAC	25,00 \$

LİMİT SWITCH

KOD	AÇIKLAMA	AD. / \$
MLP Plastik Gövde (Kontak: NO+NC, 3A/240 V AC, Snap Action)		
MLP-25 110	Dikey Pim Kısa	4,10 \$
MLP-25 112	Dikey Pim Makara, Ø12 mm, Metal	4,10 \$
MLP-25 121	Dikey Pim Düz Kol Mak. Ø12 mm, Metal	4,10 \$
MLP-25 129	Dikey Pim, Test Kol, Mak. Ø12 mm, Metal	4,10 \$
MLP-25 131	Döner Sabit Kol, Mak. Ø18 mm, Plastik	4,10 \$
MLP-25 132	Döner Sabit Kol, Mak. Ø18 mm, Metal	4,10 \$
MLP-25 137	Döner Sabit Kol, Mak. Ø50 mm, Kauçuk	4,10 \$
MLP-25 141	Döner Ayarlı Kol, Mak. Ø18 mm, Plastik	4,10 \$
MLP-25 142	Döner Ayarlı Kol, Mak. Ø18 mm, Metal	4,10 \$
MLP-25 147	Döner Ayarlı Kol, Mak. Ø50 mm, Kauçuk	4,10 \$
MLP-25 157	Döner Ayarlı Kol, Mak. Ø50 mm, Kauçuk	4,10 \$
MLP-25 190	Çok Yönlü Spiral Tel Uç	4,10 \$
MLP-25 191	Çok Yönlü Spiral Plastik Uç	4,10 \$
MLP-25 212	Resetli Dikey Pim Mak. Ø12 mm, Metal	4,20 \$
MLP-25 247	Resetli Döner Ayaklı Kol Makara Ø50 mm, Kauçuk	5,20 \$
MLP-25 257	Resetli Döner Ayaklı Uzun Kol Makara Ø50 mm, Kauçuk	5,20 \$
MLM Metal Gövde (Kontak: NO+NC, 3A/240 V AC, Snap Action)		
MLM-25 110	Dikey Pim Kısa	12,00 \$
MLM-25 112	Dikey Pim Mak. Ø12 mm, Metal	12,00 \$
MLM-25 121	Dikey Pim Kol Mak. Ø20 mm, Metal	12,00 \$
MLM-25 132	Döner Sabit Kol Mak. Ø18 mm, Metal	12,00 \$
MLM-25 137	Döner Sabit Kol Mak. Ø50 mm, Kauçuk	12,00 \$
MLM-25 142	Döner Ayarlı Kol Mak. Ø18 mm, Metal	12,00 \$
MLM-25 147	Döner Ayarlı Kol Mak. Ø50 mm, Kauçuk	12,00 \$
MLM-25 190	Çok Yönlü Spiral Tel Uç	12,00 \$
MLM-25 191	Çok Yönlü Spiral Plastik Uç	12,00 \$
MLA Metal Gövde (Kontak: NO+NC, 3A/240 V AC, Snap Action)		
MLA-25 110	Dikey Pim Kısa	8,00 \$
MLA-25 112	Dikey Pim Düz Mak. Ø12 mm, Metal	8,00 \$
MLA-25 132	Döner Sabit Kol Mak. Ø18 mm, Plastik	8,00 \$
MLA-25 142	Döner Ayarlı Kol Mak. Ø18 mm, Plastik	8,00 \$
MLA-25 182	Döner Ayarlı Kol Çubuk, Metal	8,00 \$
MLA-25 190	Çok Yönlü Spiral Tel Uç	8,00 \$
MLA-25 191	Çok Yönlü Spiral Plastik Uç	8,00 \$
MLJ Metal Gövde (Kontak: NO+NC, 4A/240 V AC, Snap Action)		
MLJ-25 110	Dikey Pim Kısa	22,00 \$
MLJ-25 111	Dikey Pim Bilyalı	22,00 \$
MLJ-25 112	Dikey Pim Makara, Ø18 mm, Metal	22,00 \$
MLJ-25 132	Döner Sabit Kol, Mak. Ø18 mm, Metal	22,00 \$
MLJ-25 133	Çatal Kol, Çift Mak. Ø18 mm, Plastik	22,00 \$
MLJ-25 137	Döner Sabit Kol, Mak. Ø50 mm, Kauçuk	22,00 \$
MLJ-25 142	Döner Ayarlı Kol, Mak. Ø18 mm, Metal	22,00 \$
MLJ-25 147	Döner Ayarlı Kol, Mak. Ø50 mm, Kauçuk	22,00 \$
MLJ-25 182	Döner Ayarlı Kol Çubuk	22,00 \$
MLJ-25 190	Çok Yönlü Spiral Tel Uç	22,00 \$
MLJ-25 191	Çok Yönlü Spiral Plastik Uç	22,00 \$

MİKRO SWITCH

KOD	AÇIKLAMA	AD. / \$
Bakalit Gövde, Vidalı Terminal (Kontak: CO, 15A/250 V AC, Snap Action)		
MGB-51 300	Kısa İnce Pim	3,20 \$
MGB-51 305	Uzun İnce Pim	3,20 \$
MGB-51 306	Kısa Pim	3,20 \$
MGB-51 307	Düz Pim	3,70 \$
MGB-51 308	Düz Makaralı Pim	3,90 \$
MGB-51 318	Ters Makaralı Pim	3,90 \$
MGB-51 701	Klasik Palet	3,20 \$
MGB-51 715	Uzun Tel Palet	3,20 \$
MGB-51 704	Makaralı, Kısa Palet	3,20 \$
MGB-51 703	Makaralı Palet	3,20 \$
MGB-51 744	Kırmalı Makaralı, Kısa Palet	3,70 \$
Switch Kılıfı		
MGB-80 000	Plastik Kılıf Düz	0,90 \$
MGB-90 000	Kauçuk Kılıf 45° Eğik Kablo Çıkışı	0,90 \$



CONTALI MİKRO SWITCH

KOD	AÇIKLAMA	AD. / \$
Contalı, Vidalı Terminal, Terminal Kapaklı (Kontak: CO, 10A/250 V AC)		
MDX-15 100	Kısa Pim	7,00 \$
MDX-15 110	Düz Pim	7,00 \$
MDX-15 310	Somunlu, Düz Pim	7,00 \$
MDX-15 311	Düz Makaralı Pim	7,00 \$
MDX-15 312	Ters Makaralı Pim	7,00 \$
MDX-15 120	Düz Palet	7,00 \$
MDX-15 121	Makaralı Palet	7,00 \$
MDX-15 166	Çok Yönlü Plastik Uçlu Spiral	7,00 \$



MİKRO SWITCH

KOD	AÇIKLAMA	AD. / \$
Terminal : 6.3 x 0.8 mm (Kontak: CO, 16A/250 V AC)		
KW3-02 000	Pimli	2,20 \$
KW3-02 001	Metal Makaralı Palet	2,30 \$
KW3-02 002	Çengel Uçlu Palet	2,30 \$
KW3-02 003	Düz Palet	2,30 \$
KW3-02 006	Metal Makaralı, Kısa Palet	2,30 \$
KW3-02 007	Uzun Palet	2,30 \$

VİNÇ KUMANDA BUTONU

KOD	AÇIKLAMA	AD. / \$
Tek Hızlı		
MVC-61 020	2 Yön	2,80 \$
MVC-61 040	4 Yön	4,20 \$
MVC-61 060	6 Yön	5,60 \$
MVC-61 080	8 Yön	7,00 \$
Tek Hızlı, Acil Stoplu		
MVC-61 520	2 Yön	10,80 \$
MVC-61 540	4 Yön	13,60 \$
MVC-61 560	6 Yön	16,40 \$
MVC-61 580	8 Yön	19,20 \$
Tek Hızlı, Acil Stoplu		
MVC-71 520	2 Yön	12,50 \$
MVC-71 540	4 Yön	17,50 \$
MVC-71 560	6 Yön	22,50 \$
MVC-71 580	8 Yön	27,50 \$
Çift Hızlı, Acil Stoplu		
MVC-82 520	2 Yön	25,00 \$
MVC-82 540	4 Yön	35,00 \$
MVC-82 560	6 Yön	45,00 \$
MVC-82 580	8 Yön	55,00 \$



AYAK PEDALI

KOD	GÖVDE / BOYUT	AD. / \$
Tek Kademeli Pedal, 2m Kablolu (Kontak: CO, 10A/250 V AC)		
MPD-15 050	Plastik / 100x62x32 mm	3,50 \$
MPD-15 090	Plastik / 100x62x32 mm	6,00 \$
MPD-15 100	Sac / 100x70x33 mm	5,00 \$
MPD-15 200	Döküm / 135x65x45 mm	5,50 \$
MPD-15 300	Döküm / 165x80x55 mm	6,00 \$
İleri - Geri Enversör Pedal 2CO+2CO		
MPD-15 325	Döküm / 165x80x55	32,00 \$
Korumalı Pedal, Tek Kademe (Kontak: CO)		
MPD-15 400	Döküm / 200x100x130 mm	22,00 \$
MPD-15 600	Döküm / 210x150x125 mm	26,00 \$



050



KOD	AÇIKLAMA / KONTAK	AD. / \$
Kumanda Kutuları, 3A/250VAC, IP65 Contalı		
MB3-BX 150	Acil Stop Butonlu	3,00 \$
MB3-BX 151	Acil Stop Butonlu Korumalı	3,20 \$
MB3-BX 110	Start Butonlu	2,50 \$
Boş Buton Kutusu (Contalı - Yüksek Tip)		
MB3-BH 100	1'li	1,10 \$
MB3-BH 200	2'li	1,50 \$
MB3-BH 300	3'lü	2,00 \$
MB3-BH 400	4'lü	2,70 \$
MB3-BH 500	5'li	4,10 \$
Buton Aksesuarları		
AP2	Yaylı Buton için Silikon Kılıf	1,00 \$
BR1	Buton için Etiket	0,30 \$
R60	Ø60 mm Emergency Stop Etiket	0,80 \$
BK11	Ø22 mm Buton Korumucu 4 Parmak	0,54 \$
BK12	Ø22 mm Buton Korumucu 2 Parmak	0,54 \$

MB3 Ø22 PLASTİK BUTON

KOD	AÇIKLAMA / KONTAK	AD. / \$
Yaylı Buton, 3A/250VAC		
MB3-EA 210	Siyah / NO	1,00 \$
MB3-EA 310	Yeşil / NO	1,00 \$
MB3-EA 420	Kırmızı / NC	1,00 \$
MB3-EA 510	Sarı / NO	1,00 \$
MB3-EA 610	Mavi / NO	1,00 \$
İşaretili Yaylı Buton, 3A/250VAC		
MB3-EA 112	Beyaz (→) / NO	1,10 \$
MB3-EA 212	Siyah (←) / NO	1,10 \$
MB3-EA 514	Sarı Alarm / NO	1,10 \$
MB3-EA 613	Mavi (↔) / NO	1,10 \$
Acil Stop Kalıcı Mantar Buton, 3A/250VAC		
MB3-ES 442	Bas-Çevir Ø30 / NC	2,00 \$
MB3-ES 542	Bas-Çevir Ø40 / NC	1,60 \$
MB3-ES 642	Bas-Çevir Ø60 / NC	3,10 \$
MB3-ES 142	Anahtarlı Ø40 / NC	3,10 \$
Yaylı Mantar Buton, 3A/250VAC		
MB3-EC 210	Siyah / NO	1,50 \$
MB3-EC 310	Yeşil / NO	1,50 \$
MB3-EC 420	Kırmızı / NC	1,50 \$
İkiz Buton, 3A/250VAC		
MB3-EA 845	Işıksız / NO+NC	2,60 \$
MB3-EW 845	Işıklı / NO+NC	3,30 \$
Kısa Mandal Buton, 3A/250VAC, (): Yaylı Poz.		
MB3-ED 210	0-1 / NO	1,20 \$
MB3-ED 410	0-(1) / NO	1,40 \$
MB3-ED 330	1-0-2 / 2NO	1,70 \$
MB3-ED 530	(1)-0-(2) / 2NO	1,90 \$
Işıklı Yaylı Buton, Ba9S Neon 220VAC 3A/250VAC		
MB3-EW 611	Beyaz / NO	2,50 \$
MB3-EW 631	Yeşil / NO	2,50 \$
MB3-EW 642	Kırmızı / NC	2,50 \$
MB3-EW 651	Sarı / NO	2,50 \$
MB3-EW 661	Mavi / NO	2,50 \$
Işıklı Yaylı Buton, LED 220VAC 3A/250VAC		
MB3-EW 771	Beyaz / NO	4,20 \$
MB3-EW 731	Yeşil / NO	4,20 \$
MB3-EW 742	Kırmızı / NC	4,20 \$
MB3-EW 751	Sarı / NO	4,20 \$
MB3-EW 761	Mavi / NO	4,20 \$
Anahtarlı Buton, 3A/250VAC, (): Yaylı Poz. X: Anahtar Çıkmaz		
MB3-EG 210	0-1 / NO	2,60 \$
MB3-EG 410	0-1 / NO	2,80 \$
MB3-EG 610	0-(1) / NO	2,80 \$
MB3-EG 330	1-0-2 / 2NO	3,10 \$
MB3-EG 030	1-0-2 / 2NO	3,30 \$
MB3-EG 730	(1)-0-(2) / 2NO	3,30 \$

MB3 Ø22 METAL BUTON

KOD	AÇIKLAMA / KONTAK	AD. / \$
Yaylı Buton, 3A/250VAC		
MB3-BA 210	Siyah / NO	1,20 \$
MB3-BA 310	Yeşil / NO	1,20 \$
MB3-BA 420	Kırmızı / NC	1,20 \$
MB3-BA 510	Sarı / NO	1,20 \$
MB3-BA 610	Mavi / NO	1,20 \$
Acil Stop ve Mantar Buton, 3A/250VAC		
MB3-BS 542	Bas - Çevir / NC	2,00 \$
MB3-BC 420	Yaylı / NC	2,00 \$
MB3-BS 142	Anahtarlı / NC	3,70 \$
Mandal Buton, 3A/250VAC		
MB3-BD 210	0-1 NO	1,50 \$
MB3-BD 330	1-0-2 / 2 NO	2,00 \$
Işıklı Yaylı Buton, Işık : 220VAC, Ba9S Neon 3A/250VAC		
MB3-BW 611	Beyaz / NO	3,60 \$
MB3-BW 631	Yeşil / NO	3,60 \$
MB3-BW 642	Kırmızı / NC	3,60 \$
MB3-BW 651	Sarı / NO	3,60 \$
MB3-BW 661	Mavi / NO	3,60 \$
İkiz Buton, 3A/250VAC		
MB3-BA 845	Işıksız / NO+NC	3,10 \$
MB3-BW 845	Işıklı / NO+NC	3,80 \$
Anahtarlı Buton, 3A/250VAC, X: Anahtar Çıkmaz		
MB3-BG 210	0-1 / NO	3,50 \$
MB3-BG 330	0-1-2 / NO	4,00 \$
Kontakt Bloğu, 3A/250VAC		
MB1-ZB 101	NO Buton için	0,50 \$
MB1-ZB 102	NC Buton için	0,50 \$

Ø22 LED SİNYAL LAMBASI



KOD	KOD	RENK	AD. / \$
220V	24V		
MB3-EV 916	MB3-EV 917	Beyaz	0,60 \$
MB3-EV 936	MB3-EV 937	Yeşil	0,55 \$
MB3-EV 946	MB3-EV 947	Kırmızı	0,55 \$
MB3-EV 956	MB3-EV 957	Sarı	0,55 \$
MB3-EV 966	MB3-EV 967	Mavi	0,60 \$

Ø22 BUZZER



KOD	AÇIKLAMA	AD. / \$
MB3-EB 164	220V Ledli	3,20 \$
MB3-EB 174	24V Ledli	3,20 \$

METAL BUTON



KOD	AÇIKLAMA / KONTAK	AD. / \$
Işıksız Metal Buton; 2A/250VAC Kontak: NO		
MBJ-16 200	Ø16 mm	4,50 \$
MBJ-19 200	Ø19 mm	5,50 \$
Ø19 Işıklı Yaylı Buton; Kontak: 2CO, 1A/250VAC IP67-Su Geçirmez, 8 Pin - 24V Led		
MBJ-19 573	Yeşil	12,00 \$
MBJ-19 574	Kırmızı	12,00 \$
MBJ-19 575	Sarı	12,00 \$
MBJ-19 576	Mavi	12,00 \$
Ø19 Işıklı Kalıcı Buton; Kontak: 2CO, 1A/250VAC IP67-Su Geçirmez, 8 Pin - 24V Led		
MBJ-19 673	Yeşil	13,00 \$
MBJ-19 674	Kırmızı	13,00 \$
MBJ-19 675	Sarı	13,00 \$
MBJ-19 676	Mavi	13,00 \$

ROCKER ANAHTAR



KOD	AÇIK.	IŞIK	RENK	AD. / \$
Dar Rocker Anahtar, Kontak:NO, 15A/250VAC Pin: 6.3x0.8mm				
MRC-50 101-4S	On-Off	2Pin-Işıksız	Kırmızı	0,36 \$
MRC-50 101-3	On-Off	3Pin-Işıklı	Yeşil	0,42 \$
MRC-50 101-4	On-Off	3Pin-Işıklı	Kırmızı	0,40 \$
MRC-50 101-5	On-Off	3Pin-Işıklı	Sarı	0,40 \$
Geniş Rocker Anahtar, Kontak:2NO, 15A/250VAC Pin: 6.3x0.8mm				
MRC-50 201-4S	On-Off	4Pin-Işıksız	Kırmızı	0,50 \$
MRC-50 201-3	On-Off	4Pin-Işıklı	Yeşil	0,58 \$
MRC-50 201-4	On-Off	4Pin-Işıklı	Kırmızı	0,52 \$
MRC-50 201-5	On-Off	4Pin-Işıklı	Sarı	0,52 \$
MRC-50 203-4	On-Off-On	6Pin-Işıklı	Kırmızı	0,68 \$
İkili Rocker Anahtar, Kontak:NO+NO, 15A/250VAC Pin: 6.3x0.8mm				
MRC-52 201-4S	On-Off	4Pin-Işıksız	Kırmızı	0,66 \$
MRC-52 201-3	On-Off	6Pin-Işıklı	Yeşil	0,76 \$
MRC-52 201-4	On-Off	6Pin-Işıklı	Kırmızı	0,68 \$
MRC-52 201-5	On-Off	6Pin-Işıklı	Sarı	0,68 \$
Yuvarlak Rocker Anahtar, Kontak:NO, 15A/250VAC Pin: 4.8x0.8mm, Ø20mm				
MRC-60 101-4S	On-Off	2Pin-Işıksız	Kırmızı	0,36 \$
MRC-60 101-3	On-Off	3Pin-Işıklı	Yeşil	0,42 \$
MRC-60 101-4	On-Off	3Pin-Işıklı	Kırmızı	0,40 \$
MRC-60 101-5	On-Off	3Pin-Işıklı	Sarı	0,40 \$
MRC-60 101-2S	On-Off	3Pin-Işıklı	Siyah	0,36 \$
MRC-60 101-2L	On-Off	3Pin-Işıklı	Siyah(Y.led)	0,40 \$

KÖPRÜ DİYOT



KOD	AÇIKLAMA	AD. / \$
MRB-21 135	35A/1000V	1,30 \$

PANO TERMOSTATI



KOD	AÇIKLAMA	AD. / \$
10A/230VAC		
MFT-26 100	80°C, Isıtma için	4,50 \$
MFT-26 200	-10°C, Soğutma için	4,50 \$

RÖLE



KOD	VOLTAJ	AD. / \$
Mini Röle, 1 Kontak - 5 Pin, 10A / 250VAC		
MRL-41 005	220 VAC	5,00 \$
MRL-41 006	12VDC	2,80 \$
MRL-41 007	24VDC	2,80 \$
Mini Röle, 2 Kontak - 8 Pin, 5A / 250VAC		
MRL-42 005	220 VAC	5,00 \$
MRL-42 006	12VDC	2,80 \$
MRL-42 007	24VDC	2,80 \$
2 Kontak - 8 Pin, Kontak: 2CO, 10A/250VAC		
MRL-52 001	12VAC	4,00 \$
MRL-52 002	24VAC	4,00 \$
MRL-52 003	48VAC	4,00 \$
MRL-52 004	110VAC	4,00 \$
MRL-52 005	220VAC	4,00 \$
MRL-52 006	12VDC	4,00 \$
MRL-52 007	24VDC	4,00 \$
MRL-52 008	48VDC	4,00 \$
4 Kontak - 14 Pin, Kontak: 4CO, 5A/250VAC		
MRL-54 001	12VAC	4,00 \$
MRL-54 002	24VAC	4,00 \$
MRL-54 003	48VAC	4,00 \$
MRL-54 004	110VAC	4,00 \$
MRL-54 005	220VAC	4,00 \$
MRL-54 006	12VDC	4,00 \$
MRL-54 007	24VDC	4,00 \$
MRL-54 008	48VDC	4,00 \$
2 Kontak - 8 Pin, Kontak: 2CO, 10A/250VAC		
MRL-62 001	12VAC	5,20 \$
MRL-62 002	24VAC	5,20 \$
MRL-62 003	48VAC	5,20 \$
MRL-62 004	110VAC	5,20 \$
MRL-62 005	220VAC	5,20 \$
MRL-62 006	12VDC	5,20 \$
MRL-62 007	24VDC	5,20 \$
MRL-62 008	48VDC	5,20 \$
3 Kontak - 11 Pin, Kontak: 3CO, 10A/250VAC		
MRL-63 001	12VAC	5,20 \$
MRL-63 002	24VAC	5,20 \$
MRL-63 003	48VAC	5,20 \$
MRL-63 004	110VAC	5,20 \$
MRL-63 005	220VAC	5,20 \$
MRL-63 006	12VDC	5,20 \$
MRL-63 007	24VDC	5,20 \$
MRL-63 008	48VDC	5,20 \$

SOLID STATE RÖLE



KOD	AÇIKLAMA	AD. / \$
DC-AC 1 Kutup, Giriş: 3-32VDC Çıkış: 24-480VAC		
MSR-21 015	1x15A	12,20 \$
MSR-21 025	1x25A	13,20 \$
MSR-21 040	1x40A	16,40 \$
MSR-21 050	1x50A	19,60 \$
MSR-21 060	1x60A	21,80 \$
MSR-21 080	1x80A	26,40 \$
MSR-21 090	1x90A	31,40 \$
DC-AC 3 Kutup, Giriş: 3-32VDC Çıkış: 24-530VAC		
MSR-23 015	3x15A	47,20 \$
MSR-23 025	3x25A	49,60 \$
MSR-23 040	3x40A	62,80 \$
MSR-23 050	3x50A	68,20 \$
MSR-23 060	3x60A	70,40 \$
MSR-23 080	3x80A	78,40 \$
MSR-23 090	3x90A	94,60 \$
AC-AC 1 Kutup, Giriş: 80-250VDC Çıkış: 24-480VAC		
MSR-51 015	1x15A	14,00 \$
MSR-51 025	1x25A	15,00 \$
MSR-51 040	1x40A	18,20 \$
MSR-51 050	1x50A	21,40 \$
MSR-51 060	1x60A	23,60 \$
MSR-51 080	1x80A	28,20 \$
MSR-51 090	1x90A	33,20 \$
AC-AC 3 Kutup, Giriş: 80-250VDC Çıkış: 24-530VAC		
MSR-53 015	3x15A	57,60 \$
MSR-53 025	3x25A	60,00 \$
MSR-53 040	3x40A	73,20 \$
MSR-53 050	3x50A	78,60 \$
MSR-53 060	3x60A	80,80 \$
MSR-53 080	3x80A	88,80 \$
MSR-53 090	3x90A	105,00 \$
DC-DC 1 Kutup, Giriş: 3-32VDC Çıkış: 5-110VDC		
MSR-31 015	1x15A	20,00 \$
MSR-31 025	1x25A	21,00 \$
MSR-31 040	1x40A	24,20 \$
MSR-31 050	1x50A	27,40 \$
MSR-31 060	1x60A	29,60 \$
Ohm-AC 1 Kutup, Giriş: 470-560kOhm Çıkış: 0-280VAC, Triac(Analog)		
MSR-91 015	1x15A	16,80 \$
MSR-91 025	1x25A	17,80 \$
MSR-91 040	1x40A	21,00 \$
MSR-91 050	1x50A	24,20 \$
MSR-91 060	1x60A	26,40 \$
Soğutucu		
MSR-99 100	1 Kutup İçin Yüzey Montaj Küçük Boy	5,80 \$
MSR-99 111	1 Kutup İçin Ray Montaj Büyük Boy	15,20 \$
MSR-99 300	3 Kutup İçin Yüzey Montaj Küçük Boy	20,00 \$
MSR-99 310	3 Kutup İçin Ray Montaj Küçük Boy	24,00 \$
MSR-99 001	Ray Montaj Aparatı	4,40 \$

M5 - 06.5 ENDÜKTİF SENSÖR

KOD	ÇIKIŞ	FONKSİYON	VOLTAJ	AD. / \$
M5, Algılama: 1mm, Düz Kafa				
LM5-3001NA	NPN	NO	10-30VDC	21,00 \$
LM5-3001PA	PNP	NO	10-30VDC	21,00 \$
M6, Algılama: 1mm, Düz Kafa				
LM6-3001NA	NPN	NO	10-30VDC	15,00 \$
LM6-3001NB	NPN	NC	10-30VDC	17,00 \$
LM6-3001PA	PNP	NO	10-30VDC	15,00 \$
LM6-3001PB	PNP	NC	10-30VDC	17,00 \$
M6, Algılama: 2mm, Çıkık Kafa				
LM6-3002NA	NPN	NO	10-30VDC	15,00 \$
LM6-3002NB	NPN	NC	10-30VDC	17,00 \$
LM6-3002PA	PNP	NO	10-30VDC	15,00 \$
LM6-3002PB	PNP	NC	10-30VDC	17,00 \$

M8 ENDÜKTİF SENSÖR

KOD	ÇIKIŞ	FONK.	VOLTAJ	AD. / \$
M8 Endüktif Sensör - Kablolu, Algılama: 1mm, Düz Kafa				
LM8-3001NA	NPN	NO	10-30VDC	14,00 \$
LM8-3001NB	NPN	NC	10-30VDC	17,00 \$
LM8-3001PA	PNP	NO	10-30VDC	14,00 \$
LM8-3001PB	PNP	NC	10-30VDC	17,00 \$
LM8-3001LA	DC 2Tel	NO	10-30VDC	24,00 \$
LM8-2001A	AC 2Tel	NO	90-250VAC	24,00 \$
Algılama: 2 mm, Çıkık Kafa				
LM8-3002NA	NPN	NO	10-30VDC	14,00 \$
LM8-3002NB	NPN	NC	10-30VDC	17,00 \$
LM8-3002PA	PNP	NO	10-30VDC	14,00 \$
LM8-3002PB	PNP	NC	10-30VDC	17,00 \$
LM8-3002LA	DC 2Tel	NO	10-30VDC	24,00 \$
LM8-2002A	AC 2Tel	NO	90-250VAC	24,00 \$
M8 Endüktif Sensör - Konnektörlü				
M8 Konnektörlü, Algılama: 1mm, Düz Kafa				
LM8-3001NAT	NPN	NO	10-30VDC	19,00 \$
LM8-3001NBT	NPN	NC	10-30VDC	22,00 \$
LM8-3001PAT	PNP	NO	10-30VDC	19,00 \$
LM8-3001PBT	PNP	NC	10-30VDC	22,00 \$
M8 Konnektörlü, Algılama: 2 mm, Çıkık Kafa				
LM8-3002NAT	NPN	NO	10-30VDC	19,00 \$
LM8-3002NBT	NPN	NC	10-30VDC	22,00 \$
LM8-3002PAT	PNP	NO	10-30VDC	19,00 \$
LM8-3002PBT	PNP	NC	10-30VDC	22,00 \$
M12 Konnektörlü, Algılama: 1 mm, Düz Kafa				
LM8-3001NAT-M12	NPN	NO	10-30VDC	21,00 \$
LM8-3001NBT-M12	NPN	NC	10-30VDC	24,00 \$
LM8-3001PAT-M12	PNP	NO	10-30VDC	21,00 \$
LM8-3001PBT-M12	PNP	NC	10-30VDC	24,00 \$
M12 Konnektörlü, Algılama: 2 mm, Çıkık Kafa				
LM8-3002NAT-M12	NPN	NO	10-30VDC	21,00 \$
LM8-3002NBT-M12	NPN	NC	10-30VDC	24,00 \$
LM8-3002PAT-M12	PNP	NO	10-30VDC	21,00 \$
LM8-3002PBT-M12	PNP	NC	10-30VDC	24,00 \$

M8 ENDÜKTİF SENSÖR

KOD	ÇIKIŞ	FONK.	VOLTAJ	AD. / \$
M8 Endüktif Sensör - Uzun Algılama - Kablolu				
Algılama: 2 mm Düz Kafa				
LM8-3002FNA	NPN	NO	10-30VDC	26,00 \$
LM8-3002FPA	PNP	NO	10-30VDC	26,00 \$
M8 Endüktif Sensör - Uzun Algılama - Kablolu				
Algılama: 3 mm Çıkık Kafa				
LM8-3003LNA	NPN	NO	10-30VDC	26,00 \$
LM8-3003LPA	PNP	NO	10-30VDC	26,00 \$
M8x30 mm Endüktif Sensör - Kısa Gövde - Kablolu				
Algılama: 1 mm Düz Kafa				
LM8-3001SNA	NPN	NO	10-30VDC	26,00 \$
LM8-3001SPA	PNP	NO	10-30VDC	26,00 \$
M8x30 mm Endüktif Sensör - Kısa Gövde - Kablolu				
Algılama: 2 mm Çıkık Kafa				
LM8-3002SNA	NPN	NO	10-30VDC	26,00 \$
LM8-3002SPA	PNP	NO	10-30VDC	26,00 \$

M12 ENDÜKTİF SENSÖR

KOD	ÇIKIŞ	FONK.	VOLTAJ	AD. / \$
M12 Endüktif Sensör - Kablolu,				
Algılama: 2mm, Düz Kafa				
LM12-3002NA	NPN	NO	10-30VDC	9,50 \$
LM12-3002NC	NPN	NO+NC	10-30VDC	13,50 \$
LM12-3002PA	PNP	NO	10-30VDC	9,50 \$
LM12-3002PC	PNP	NO+NC	10-30VDC	13,50 \$
LM12-3002LA	DC 2Tel	NO	10-30VDC	17,50 \$
LM12-3002LB	DC 2Tel	NC	10-30VDC	17,50 \$
LM12-2002A	AC 2Tel	NO	90-250VAC	17,50 \$
M12 Endüktif Sensör - Kablolu,				
Algılama: 4 mm, Çıkık Kafa				
LM12-3004NA	NPN	NO	10-30VDC	9,50 \$
LM12-3004NC	NPN	NO+NC	10-30VDC	13,50 \$
LM12-3004PA	PNP	NO	10-30VDC	9,50 \$
LM12-3004PC	PNP	NO+NC	10-30VDC	13,50 \$
LM12-3004LA	DC 2Tel	NO	10-30VDC	17,50 \$
LM12-3004LB	DC 2Tel	NC	10-30VDC	17,50 \$
LM12-2004A	AC 2Tel	NO	90-250VAC	17,50 \$
M12 Endüktif Sensör - M12 Konnektörlü				
Algılama: 2 mm, Düz Kafa				
LM12-3002NAT	NPN	NO	10-30VDC	11,50 \$
LM12-3002NCT	NPN	NO+NC	10-30VDC	15,50 \$
LM12-3002PAT	PNP	NO	10-30VDC	11,50 \$
LM12-3002PCT	PNP	NO+NC	10-30VDC	15,50 \$
M12 Endüktif Sensör - M12 Konnektörlü				
Algılama: 4 mm, Çıkık Kafa				
LM12-3004NAT	NPN	NO	10-30VDC	11,50 \$
LM12-3004NCT	NPN	NO+NC	10-30VDC	15,50 \$
LM12-3004PAT	PNP	NO	10-30VDC	11,50 \$
LM12-3004PCT	PNP	NO+NC	10-30VDC	15,50 \$

M12 ENDÜKTİF SENSÖR

KOD	ÇIKIŞ	FONK.	VOLTAJ	AD. / \$
M12 Endüktif Sensör - Uzun Algılama - Kablolu, Algılama: 4 mm, Düz Kafa				
LM12-3004FNC	NPN	NO+NC	10-30VDC	20,50 \$
LM12-3004FPC	PNP	NO+NC	10-30VDC	20,50 \$
M12 Endüktif Sensör - Uzun Algılama - Kablolu Algılama: 6 mm Çıkık Kafa				
LM12-3006LNC	NPN	NO+NC	10-30VDC	20,50 \$
LM12-3006LPC	PNP	NO+NC	10-30VDC	20,50 \$
M12x35 mm Endüktif Sensör - Kısa Gövde - Kablolu, Algılama: 2 mm Düz Kafa				
LM12-3002SNA	NPN	NO	10-30VDC	20,50 \$
LM12-3002SPA	PNP	NO	10-30VDC	20,50 \$
M12x35 mm Endüktif Sensör - Kısa Gövde - Kablolu, Algılama: 4 mm Çıkık Kafa				
LM12-3004SNA	NPN	NO	10-30VDC	20,50 \$
LM12-3004SPA	PNP	NO	10-30VDC	20,50 \$

M18 ENDÜKTİF SENSÖR

KOD	ÇIKIŞ	FONK.	VOLTAJ	AD. / \$
M18 Endüktif Sensör - Kablolu, Algılama: 5mm, Düz Kafa				
LM18-3005NA	NPN	NO	10-30VDC	11,50 \$
LM18-3005NC	NPN	NO+NC	10-30VDC	15,50 \$
LM18-3005PA	PNP	NO	10-30VDC	11,50 \$
LM18-3005PC	PNP	NO+NC	10-30VDC	15,50 \$
LM18-3005LA	DC 2Tel	NO	10-30VDC	21,50 \$
LM18-3005LB	DC 2Tel	NC	10-30VDC	21,50 \$
LM18-2005A	AC 2Tel	NO	90-250VAC	21,50 \$
M12 Endüktif Sensör - Kablolu, Algılama: 8 mm, Çıkık Kafa				
LM18-3008NA	NPN	NO	10-30VDC	11,50 \$
LM18-3008NC	NPN	NO+NC	10-30VDC	15,50 \$
LM18-3008PA	PNP	NO	10-30VDC	11,50 \$
LM18-3008PC	PNP	NO+NC	10-30VDC	15,50 \$
LM18-3008LA	DC 2Tel	NO	10-30VDC	21,50 \$
LM18-3008LB	DC 2Tel	NC	10-30VDC	21,50 \$
LM18-2008A	AC 2Tel	NO	90-250VAC	21,50 \$
M18 Endüktif Sensör - M12 Konnektörlü Algılama: 5 mm, Düz Kafa				
LM18-3005NAT	NPN	NO	10-30VDC	13,50 \$
LM18-3005NCT	NPN	NO+NC	10-30VDC	18,50 \$
LM18-3005PAT	PNP	NO	10-30VDC	13,50 \$
LM18-3005PCT	PNP	NO+NC	10-30VDC	18,50 \$
M18 Endüktif Sensör - M12 Konnektörlü Algılama: 8 mm, Çıkık Kafa				
LM18-3008NAT	NPN	NO	10-30VDC	13,50 \$
LM18-3008NCT	NPN	NO+NC	10-30VDC	18,50 \$
LM18-3008PAT	PNP	NO	10-30VDC	13,50 \$
LM18-3008PCT	PNP	NO+NC	10-30VDC	18,50 \$
M18 Endüktif Sensör - Uzun Algılama - Kablolu, Algılama: 7 mm, Düz Kafa				
LM18-3007FNC	NPN	NO+NC	10-30VDC	28,00 \$
LM18-3007FPC	PNP	NO+NC	10-30VDC	28,00 \$
M18 Endüktif Sensör - Uzun Algılama - Kablolu Algılama: 12 mm Çıkık Kafa				
LM18-3012LNC	NPN	NO+NC	10-30VDC	28,00 \$
LM18-3012LPC	PNP	NO+NC	10-30VDC	28,00 \$
M18x47 mm Endüktif Sensör - Kısa Gövde - Kablolu, Algılama: 5 mm Düz Kafa				
LM18-3005SNC	NPN	NO+NC	10-30VDC	28,00 \$
LM18-3005SPC	PNP	NO+NC	10-30VDC	28,00 \$
M18x47 mm Endüktif Sensör - Kısa Gövde - Kablolu, Algılama: 8 mm Çıkık Kafa				
LM18-3008SNC	NPN	NO+NC	10-30VDC	28,00 \$
LM18-3008SPC	PNP	NO+NC	10-30VDC	28,00 \$

M30 ENDÜKTİF SENSÖR

KOD	ÇIKIŞ	FONK.	VOLTAJ	AD. / \$
M30 Endüktif Sensör - Kablolu, Algılama: 10mm, Düz Kafa				
LM30-3010NA	NPN	NO	10-30VDC	17,50 \$
LM30-3010NC	NPN	NO+NC	10-30VDC	22,50 \$
LM30-3010PA	PNP	NO	10-30VDC	17,50 \$
LM30-3010PC	PNP	NO+NC	10-30VDC	22,50 \$
LM30-3010LA	DC 2Tel	NO	10-30VDC	29,00 \$
LM30-2010A	AC 2Tel	NO	90-250VAC	29,00 \$
M30 Endüktif Sensör - Kablolu, Algılama: 15 mm, Çıkık Kafa				
LM30-3015NA	NPN	NO	10-30VDC	17,50 \$
LM30-3015NC	NPN	NO+NC	10-30VDC	22,50 \$
LM30-3015PA	PNP	NO	10-30VDC	17,50 \$
LM30-3015PC	PNP	NO+NC	10-30VDC	22,50 \$
LM30-3015LA	DC 2Tel	NO	10-30VDC	29,00 \$
LM30-2015A	AC 2Tel	NO	90-250VAC	29,00 \$
M30 Endüktif Sensör - M12 Konnektörlü Algılama: 10 mm, Düz Kafa				
LM30-3010NCT	NPN	NO+NC	10-30VDC	24,50 \$
LM30-3010PCT	NPN	NO+NC	10-30VDC	24,50 \$
M30 Endüktif Sensör - M12 Konnektörlü Algılama: 15 mm, Çıkık Kafa				
LM30-3015NCT	PNP	NO+NC	10-30VDC	24,50 \$
LM30-3015PCT	PNP	NO+NC	10-30VDC	24,50 \$
M30 Endüktif Sensör - Uzun Algılama - Kablolu, Algılama: 14 mm, Düz Kafa				
LM30-3014FNC	NPN	NO+NC	10-30VDC	26,50 \$
LM30-3014FPC	PNP	NO+NC	10-30VDC	26,50 \$
M30 Endüktif Sensör - Uzun Algılama - Kablolu Algılama: 20 mm Çıkık Kafa				
LM30-3020LNC	NPN	NO+NC	10-30VDC	26,50 \$
LM30-3020LPC	PNP	NO+NC	10-30VDC	26,50 \$
M30x58 mm Endüktif Sensör - Kısa Gövde - Kablolu, Algılama: 10 mm Düz Kafa				
LM30-3010SNC	NPN	NO+NC	10-30VDC	26,50 \$
LM30-3010SPC	PNP	NO+NC	10-30VDC	26,50 \$
M30x58 mm Endüktif Sensör - Kısa Gövde - Kablolu, Algılama: 15 mm Çıkık Kafa				
LM30-3015SNC	NPN	NO+NC	10-30VDC	26,50 \$
LM30-3015SPC	PNP	NO+NC	10-30VDC	26,50 \$

KÜBİK ENDÜKTİF SENSÖR

KOD	ÇIKIŞ	FONK.	VOLTAJ	AD. / \$
17x17x35mm-Kablolu, Algılama: 8 mm				
LT4-3008NC	NPN	NO+NC	10-30VDC	9,00 \$
LT4-3008PC	PNP	NO+NC	10-30VDC	9,00 \$
LT4-2008A	AC 2Tel	NO	90-250VAC	16,50 \$



KAPASİTİF SENSÖR

KOD	ÇIKIŞ	FONK.	VOLTAJ	AD. /
M12 Kapasitif Sensör - Kablolu, Ayarlı Algılama: 2mm, Düz Kafa				
CM12-3002NA	NPN	NO	10-30VDC	38,00 \$
CM12-3002PA	PNP	NO	10-30VDC	38,00 \$
M12 Kapasitif Sensör - Kablolu, Ayarlı Algılama: 4mm, Çıkık Kafa				
CM12-3004NA	NPN	NO	10-30VDC	38,00 \$
CM12-3004PA	PNP	NO	10-30VDC	38,00 \$
M18 Kapasitif Sensör - Kablolu, Ayarlı Algılama: 5mm, Düz Kafa				
CM18-3005NC	NPN	NO+NC	10-30VDC	38,00 \$
CM18-3005PC	PNP	NO+NC	10-30VDC	38,00 \$
CM18-2005A	AC 2Tel	NO	90-250VAC	40,00 \$
CM18-2005B	AC 2Tel	NC	90-250VAC	40,00 \$
M18 Kapasitif Sensör - Kablolu, Ayarlı Algılama: 8mm, Çıkık Kafa				
CM18-3008NC	NPN	NO+NC	10-30VDC	38,00 \$
CM18-3008PC	PNP	NO+NC	10-30VDC	38,00 \$
CM18-2008A	AC 2Tel	NO	90-250VAC	40,00 \$
CM18-2008B	AC 2Tel	NC	90-250VAC	40,00 \$
M30 Kapasitif Sensör - Kablolu, Ayarlı Algılama: 15mm, Düz Kafa				
CM30-3015NC	NPN	NO+NC	10-30VDC	38,00 \$
CM30-3015PC	PNP	NO+NC	10-30VDC	38,00 \$
CM30-2015A	AC 2Tel	NO	90-250VAC	40,00 \$
CM30-2015B	AC 2Tel	NC	90-250VAC	40,00 \$
M30 Kapasitif Sensör - Kablolu, Ayarlı Algılama: 20mm, Çıkık Kafa				
CM30-3020NC	NPN	NO+NC	10-30VDC	38,00 \$
CM30-3020PC	PNP	NO+NC	10-30VDC	38,00 \$
CM30-2020A	AC 2Tel	NO	90-250VAC	40,00 \$
CM30-2020B	AC 2Tel	NC	90-250VAC	40,00 \$



M18 FOTOSEL - PLASTİK GÖVDE

KOD	ÇIKIŞ	FONK.	VOLTAJ	AD. / \$
M18 Fotosel - Cisimden Yansımali 2 m. Kablolu, Ayarlı, Algılama: 10 cm				
G18-3A10NA	NPN	NO	10-30VDC	20,00 \$
G18-3A10NC	NPN	NO+NC	10-30VDC	24,00 \$
G18-3A10PA	PNP	NO	10-30VDC	20,00 \$
G18-3A10PC	PNP	NO+NC	10-30VDC	24,00 \$
G18-3A10LA	DC 2Tel	NO	10-30VDC	34,00 \$
G18-3A10LB	DC 2Tel	NC	10-30VDC	34,00 \$
G18-2A10A	AC 2Tel	NO	90-250VAC	34,00 \$
G18-2A10B	AC 2Tel	NC	90-250VAC	34,00 \$
M18 Fotosel - Cisimden Yansımali M12 Konnektörlü, Ayarlı, Algılama: 10 cm				
G18-3A10NAT	NPN	NO	10-30VDC	26,00 \$
G18-3A10NCT	NPN	NO+NC	10-30VDC	30,00 \$
G18-3A10PAT	PNP	NO	10-30VDC	26,00 \$
G18-3A10PCT	PNP	NO+NC	10-30VDC	30,00 \$
M18 Fotosel - Cisimden Yansımali 2 m. Kablolu, Ayarlı, Algılama: 50 cm				
G18-3A50NA	NPN	NO	10-30VDC	22,00 \$
G18-3A50NC	NPN	NO+NC	10-30VDC	26,00 \$
G18-3A50PA	PNP	NO	10-30VDC	22,00 \$
G18-3A50PC	PNP	NO+NC	10-30VDC	26,00 \$
G18-3A50LA	DC 2Tel	NO	10-30VDC	36,00 \$
G18-3A50LB	DC 2Tel	NC	10-30VDC	36,00 \$
G18-2A50A	AC 2Tel	NO	90-250VAC	36,00 \$
G18-2A50B	AC 2Tel	NC	90-250VAC	36,00 \$
M18 Fotosel - Cisimden Yansımali M12 Konnektörlü, Ayarlı, Algılama: 50 cm				
G18-3A50NAT	NPN	NO	10-30VDC	28,00 \$
G18-3A50NCT	NPN	NO+NC	10-30VDC	32,00 \$
G18-3A50PAT	PNP	NO	10-30VDC	28,00 \$
G18-3A50PCT	PNP	NO+NC	10-30VDC	32,00 \$
M18 Fotosel - 4m Reflektörlü, 2 m. Kablolu, Ayarlı, Algılama: 4 m.				
G18-3B4NA	NPN	NO	10-30VDC	24,00 \$
G18-3B4NC	NPN	NO+NC	10-30VDC	28,00 \$
G18-3B4PA	PNP	NO	10-30VDC	24,00 \$
G18-3B4PC	PNP	NO+NC	10-30VDC	28,00 \$
G18-3B4LA	DC 2Tel	NO	10-30VDC	38,00 \$
G18-3B4LB	DC 2Tel	NC	10-30VDC	38,00 \$
G18-2B4A	AC 2Tel	NO	90-250VAC	38,00 \$
G18-2B4B	AC 2Tel	NC	90-250VAC	38,00 \$
M18 Fotosel - 4m Reflektörlü, M12 Konnektörlü, Ayarlı, Algılama: 4 m. (Reflektör fiyata dahil değildir.)				
G18-3B4NAT	NPN	NO	10-30VDC	30,00 \$
G18-3B4NCT	NPN	NO+NC	10-30VDC	34,00 \$
G18-3B4PAT	PNP	NO	10-30VDC	30,00 \$
G18-3B4PCT	PNP	NO+NC	10-30VDC	34,00 \$
M18 Fotosel - 12m. Karşılıklı, 2 m. Kablolu, Ayarlı, Algılama: 12 m.				
G18-3C12NA	NPN	NO	10-30VDC	36,00 \$
G18-3C12NC	NPN	NO+NC	10-30VDC	40,00 \$
G18-3C12PA	PNP	NO	10-30VDC	36,00 \$
G18-3C12PC	PNP	NO+NC	10-30VDC	40,00 \$
G18-3C12LA	DC 2Tel	NO	10-30VDC	50,00 \$
G18-3C12LB	DC 2Tel	NC	10-30VDC	50,00 \$
G18-2C12A	AC 2Tel	NO	90-250VAC	50,00 \$
G18-2C12B	AC 2Tel	NC	90-250VAC	50,00 \$
M18 Fotosel - 12m. Karşılıklı, M12 Konnektörlü Ayarlı, Algılama: 12 m.				
G18-3C12NAT	NPN	NO	10-30VDC	42,00 \$
G18-3C12NCT	NPN	NO+NC	10-30VDC	46,00 \$
G18-3C12PAT	PNP	NO	10-30VDC	42,00 \$
G18-3C12PCT	PNP	NO+NC	10-30VDC	46,00 \$



KONNEKTÖR

KOD	KABLO	LED	BAĞLANTI	AD. / \$
M8 Düz				
CN8-3020-S	2m	Yok	3 Tel	6,50 \$
CN8-3050-S	5m	Yok	3 Tel	10,00 \$
CN8-4050-S	5m	Yok	4 Tel	11,50 \$
CN8-4100-S	10m	Yok	4 Tel	19,00 \$
M8 90°C				
CN8-3020-R	2m	Yok	3 Tel	6,50 \$
CN8-3050-R	5m	Yok	3 Tel	10,00 \$
CN8-4050-R	5m	Yok	4 Tel	11,50 \$
CN8-4100-R	10m	Yok	4 Tel	19,00 \$
M12 Düz				
CN12-3020-S	2m	Yok	3 Tel	6,50 \$
CN12-3050-S	5m	Yok	3 Tel	10,00 \$
CN12-3100-S	10m	Yok	3 Tel	16,00 \$
CN12-4020-S	2m	Yok	4 Tel	7,00 \$
CN12-4050-S	5m	Yok	4 Tel	11,50 \$
CN12-4100-S	10m	Yok	4 Tel	19,00 \$
M12 90°C 3 TEL				
CN12-3020-R	2m	Yok	3 Tel	6,50 \$
CN12-3020-RN	2m	Led NPN	3 Tel	8,00 \$
CN12-3020-RP	2m	Led PNP	3 Tel	8,00 \$
CN12-3050-R	5m	Yok	3 Tel	10,00 \$
CN12-3050-RN	5m	Led NPN	3 Tel	11,50 \$
CN12-3050-RP	5m	Led PNP	3 Tel	11,50 \$
M12 90°C 4 TEL				
CN12-4020-R	2m	Yok	4 Tel	7,00 \$
CN12-4050-R	5m	Yok	4 Tel	11,50 \$
CN12-4050-RN	5m	Led NPN	4 Tel	13,00 \$
CN12-4050-RP	5m	Led PNP	4 Tel	13,00 \$
CN12-4100-R	10m	Yok	4 Tel	19,00 \$
CN12-4100-RN	10m	Led NPN	4 Tel	20,50 \$
CN12-4100-RP	10m	Led PNP	4 Tel	20,50 \$

REFLEKTÖR

KOD	BOYUT	AD. / \$
TD-04065	40 x 65mm	7,00 \$
TD-05162	51 x 62mm	9,00 \$
TD-05575	55 x 75mm	10,00 \$
TD-05781	57 x 81mm	10,00 \$
TD-18040	180 x 40mm	12,00 \$
TD-00040	Ø40mm	6,00 \$
TD-00082	Ø82mm	7,00 \$

KAPLIN

KOD	MİL	GÖVDE	AD. / \$
Plastik Kaplin			
RXC-11 166	6 x 6	Ø15 x 20	6,00 \$
RXC-11 188	8 x 8	Ø19 x 23	6,00 \$
Alüminyum Kaplin Lazer Kesim, Düz Kafa			
RXC-21 166	6 x 6	Ø18 x 25	35,00 \$
RXC-21 168	6 x 8	Ø20 x 25	35,00 \$
RXC-21 169	6 x 10	Ø20 x 25	35,00 \$
RXC-21 188	8 x 8	Ø20 x 25	35,00 \$
RXC-21 190	8 x 10	Ø20 x 25	35,00 \$
RXC-21 191	10 x 10	Ø20 x 25	35,00 \$
Alüminyum Kaplin Lazer Kesim, Pens Kafa			
RXC-22 166	6 x 6	Ø24 x 25	38,00 \$
RXC-22 188	8 x 8	Ø24 x 25	38,00 \$
RXC-22 191	10 x 10	Ø24 x 25	38,00 \$

POTANSİYOMETRE VE DİAL

KOD	AÇIKLAMA	AD. / \$
Ø22 Tek Tur Potansiyometre		
MPT-21 001	1 kOhm	10,00 \$
MPT-21 002	2.2 kOhm	10,00 \$
MPT-21 005	5 kOhm	10,00 \$
MPT-21 010	10 kOhm	10,00 \$
Tek Tur Potansiyometre, 2W		
MPT-11 001	1 kOhm	2,50 \$
MPT-11 002	2.2 kOhm	2,50 \$
MPT-11 005	5 kOhm	2,50 \$
MPT-11 010	10 kOhm	2,50 \$
Çok Tur Potansiyometre, 2W		
MPT-42 001	1 kOhm	6,30 \$
MPT-42 002	2.2 kOhm	6,30 \$
MPT-42 005	5 kOhm	6,30 \$
MPT-42 010	10 kOhm	6,30 \$
Metal Dial		
MPT-82 201	Tek Tur Küçük Ø29mm	1,60 \$
MPT-82 202	Tek Tur Büyük Ø36mm	2,00 \$
MPT-82 220	Çok Tur Küçük Ø22mm	9,50 \$
MPT-82 620	Çok Tur Büyük Ø46mm	17,00 \$

ASANSÖR ELEKTRİK DAĞITIM PANOSU



KOD	AÇIKLAMA	AD. / \$
	6 Kutuplu (6x40A Şalterli) 2 Kaçak Akım Rölesi	
MB3-CB264	Momentum	78,00 \$

ALARM BUTONU



KOD	AÇIKLAMA	AD. / \$
MB3-BX 110	Alarm Butonu	2,60 \$

KORUMALI ACİL STOP BUTONU



KOD	AÇIKLAMA	AD. / \$
MB3-BX 151	Korumalı Acil Stop Butonu	\$

ALARM + ACİL STOP



KOD	AÇIKLAMA	AD. / \$
MB3-BX 240	Alarm Butonu	5,40 \$

ALARM



KOD	AÇIKLAMA	AD. / \$
MB3-BX 121	Pilli	10,50 \$

ALARM+ACİL STOP



KOD	AÇIKLAMA	AD. / \$
MB3-BX 241	Pilli	12,50 \$

KUYU DİBİ REVİZYON KUTUSU



KOD	AÇIKLAMA	AD. / \$
MB3-CK 400	Butonlu	25,00 \$

REVİZYON ELLE KUMANDA 4'LÜ



KOD	AÇIKLAMA	AD. / \$
MB3-BZ 411	El Kumanda	8,00 \$

REVİZYON KARTI



KOD	AÇIKLAMA	AD. / \$
MB3-CR 100P	Trafosuz	12,00 \$
MB3-CK 100P	Trafolu	16,00 \$

FRENLEME DİRENCİ



KOD	AÇIKLAMA	AD. / \$
MAS-B1500	1500W	⌚

TRAFO



KOD	AÇIKLAMA	AD. / \$
MTR-150	150W	⌚
MTR-250	250W	

ŞERİT MİKNATIS



KOD	AÇIKLAMA	AD. / \$
MLV-M100	10cm	0,50 \$
MLV-M300	30cm	1,50 \$

REVİZYON ELLE KUMANDA 5'Lİ



KOD	AÇIKLAMA	AD. / \$
MB3-BZ 515	El Kumanda	10,00 \$

REVİZYON ELLE KUMANDA 6'Lİ



KOD	AÇIKLAMA	AD. / \$
MB3-BZ 516	El Kumanda	16,00 \$

Ø18 mm TÜP MANYETİK



KOD	AÇIKLAMA	AD. / \$
MM18-SM100	Monostabil	3,00 \$
MM18-SB100	Bistabil	3,00 \$

Ø12 mm TÜP MANYETİK



KOD	AÇIKLAMA	AD. / \$
MM12-SM100	Monostabil	4,00 \$
MM12-SB100	Bistabil	4,00 \$

FAZ KORUMA RÖLESİ



KOD	AÇIKLAMA	AD. / \$
RT8-MP 130	Faz Sıralı, PTC'li %40	14,00 \$

NEOZED BUŞON



KOD	CİNSİ	AD. / €
DF201102-16	Do 1 Size 2-4-6-10-16 A 400V	2,00 €
DF201120-63	Do 2 Size 20-25-35-50-63 400V	2,24 €

SİGORTA YUVALARI



KOD	CİNSİ	AD. / €
DF 485001	PM F, 8 x 31 1P	5,40 €
DF 485101	PM F, 10 x 38 1P	4,00 €
DF 485104	PM F, 10 x 38 2P	9,00 €
DF 485105	PM F, 10 x 38 3P	14,00 €
DF 485201	PM 1, 14 x 51 1P	8,50 €
DF 485204	PM 1, 14 x 51 2P	17,60 €
DF 485205	PM 1, 14 x 51 3P	27,00 €
DF 485207	PM1, 14 x 51 4P	38,00 €
DF 485301	PM 2, 22 x 58 1P	17,00 €
DF 485304	PM 2, 22 x 58 2P	37,00 €
DF 485305	PM 2, 22 x 58 3P	54,00 €
DF 485307	PM 2, 22 x 58 4P	72,00 €
DF 485208	14 x 51 Ledli	24,00 €
DF 485308	22 x 58 Ledli	28,00 €
DF 485150	PM F 10 x 38, 1P 1000VDC	4,60 €
DF 485250	PM X 14 x 51, 1P 1000VDC	12,00 €

HIZLI SİGORTALAR

10 x 38



KOD	CİNSİ	AD. / €
DF 492001	H. Sigorta 10 x 38, 600V, 1A	6,00 €
DF 492002	H. Sigorta 10 x 38, 600V, 2A	6,00 €
DF 492002	H. Sigorta 10 x 38, 600V, 3A	6,00 €
DF 492003	H. Sigorta 10 x 38, 600V, 4A	4,00 €
DF 492004	H. Sigorta 10 x 38, 600V, 6A	4,00 €
DF 492005	H. Sigorta 10 x 38, 600V, 8A	4,00 €
DF 492006	H. Sigorta 10 x 38, 600V, 10A	4,00 €
DF 492007	H. Sigorta 10 x 38, 600V, 12A	4,00 €
DF 492008	H. Sigorta 10 x 38, 600V, 16A	4,00 €
DF 492009	H. Sigorta 10 x 38, 600V, 20A	4,00 €
DF 492010	H. Sigorta 10 x 38, 600V, 25A	4,00 €
DF 492011	H. Sigorta 10 x 38, 600V, 32A	4,00 €

HIZLI SİGORTALAR

14 x 51



22 x 58

KOD	CİNSİ	AD. / €
DF 491200	H. Sigorta 14 x 51, 660V, 1A	8,00 €
DF 491205	H. Sigorta 14 x 51, 660V, 2A	8,00 €
DF 491210	H. Sigorta 14 x 51, 660V, 3A	8,00 €
DF 492014	H. Sigorta 14 x 51, 660V, 4A	8,00 €
DF 492015	H. Sigorta 14 x 51, 660V, 6A	6,00 €
DF 492017	H. Sigorta 14 x 51, 660V, 10A	6,00 €
DF 492018	H. Sigorta 14 x 51, 660V, 12A	6,00 €
DF 492019	H. Sigorta 14 x 51, 660V, 16A	6,00 €
DF 492020	H. Sigorta 14 x 51, 660V, 20A	6,00 €
DF 492021	H. Sigorta 14 x 51, 660V, 25A	6,00 €
DF 492022	H. Sigorta 14 x 51, 660V, 32A	6,00 €
DF 492023	H. Sigorta 14 x 51, 660V, 40A	6,00 €
DF 492024	H. Sigorta 14 x 51, 660V, 50A	6,00 €

10 x 38, 1000 V DC SOLAR SİGORTA BUŞONU



KOD	CİNSİ	AD. / €
DF 491601-635	10 x 38 1000 V DC 1-20 A	4,60 €
DF 491901-945	10 x 38 600 V DC 1-32 A	4,60 €
DF 491650	14 x 51 1000 V DC, 25 A	11,00 €
DF 491655	14 x 51 1000 V DC, 32 A	11,00 €
DF 480033	S. Yu. PM F 10 x 38 1P	4,60 €
DF 485250	S. Yu. PM X 14 x 51 1P	11,0 €

NORMAL BUŞON (500 V)



KOD	CİNSİ	AD. / €
DF 101002-25	DI, 2-4-6-10-16-20-25A, 50kE, E16	2,40 €
DF 101102-25	DII, 2-4-6-10-16-20-25A, 50kE, E27	1,60 €
DF 101135-63	DIII, 35-50-63A, 50kE, E33	2,40 €

PORSELEN SİGORTALAR

8 x 31 gG



KOD	CİNSİ	AD. / €
DF 420500	Porselen Sigorta 8 x 31 0.5A	1,00 €
DF 420501	Porselen Sigorta 8 x 31 1A	1,00 €
DF 420502	Porselen Sigorta 8 x 31 2A	1,00 €
DF 420504	Porselen Sigorta 8 x 31 4A	1,00 €
DF 420506	Porselen Sigorta 8 x 31 6A	1,00 €
DF 420508	Porselen Sigorta 8 x 31 8A	1,00 €
DF 420510	Porselen Sigorta 8 x 31 10A	1,00 €
DF 420512	Porselen Sigorta 8 x 31 12A	1,00 €
DF 420516	Porselen Sigorta 8 x 31 16A	1,00 €
DF 420720	Porselen Sigorta 8 x 31 20A	1,00 €

PORSELEN SİGORTALAR

10 x 38 gG



KOD	CİNSİ	AD. / €
DF 420000	Porselen Sigorta 10.3x38 0.5A	0,80 €
DF 420001	Porselen Sigorta 10.3x38 1A	0,80 €
DF 420002	Porselen Sigorta 10.3x38 2A	0,80 €
DF 420004	Porselen Sigorta 10.3x38 4A	0,80 €
DF 420006	Porselen Sigorta 10.3x38 6A	0,80 €
DF 420008	Porselen Sigorta 10.3x38 8A	0,80 €
DF 420010	Porselen Sigorta 10.3x38 10A	0,80 €
DF 420012	Porselen Sigorta 10.3x38 12A	0,80 €
DF 420016	Porselen Sigorta 10.3x38 16A	0,80 €
DF 420020	Porselen Sigorta 10.3x38 20A	0,80 €
DF 420025	Porselen Sigorta 10.3x38 25A	0,80 €
DF 420032	Porselen Sigorta 10.3x38 32A	0,80 €

PORSELEN SİGORTALAR

14 x 51 gG



KOD	CİNSİ	AD. / €
DF 421001	Porselen Sigorta 14.3x51 1A	2,00 €
DF 421002	Porselen Sigorta 14.3x51 2A	1,50 €
DF 421004	Porselen Sigorta 14.3x51 4A	1,50 €
DF 421006	Porselen Sigorta 14.3x51 6A	1,50 €
DF 421008	Porselen Sigorta 14.3x51 8A	1,50 €
DF 421010	Porselen Sigorta 14.3x51 10A	1,50 €
DF 421012	Porselen Sigorta 14.3x51 12A	1,50 €
DF 421016	Porselen Sigorta 14.3x51 16A	1,50 €
DF 421020	Porselen Sigorta 14.3x51 20A	1,50 €
DF 421025	Porselen Sigorta 14.3x51 25A	1,50 €
DF 421032	Porselen Sigorta 14.3x51 32A	1,50 €
DF 421040	Porselen Sigorta 14.3x51 40A	1,50 €
DF 421050	Porselen Sigorta 14.3x51 50A	1,50 €

PORSELEN SİGORTALAR

22 x 58 gG



KOD	CİNSİ	AD. / €
DF 422002	Porselen Sigorta 14.3x51 2A	2,50 €
DF 422004	Porselen Sigorta 14.3x51 4A	2,50 €
DF 422006	Porselen Sigorta 14.3x51 6A	2,50 €
DF 422008	Porselen Sigorta 14.3x51 8A	2,50 €
DF 422010	Porselen Sigorta 14.3x51 10A	2,50 €
DF 422012	Porselen Sigorta 14.3x51 12A	2,50 €
DF 422016	Porselen Sigorta 14.3x51 16A	1,50 €
DF 422020	Porselen Sigorta 14.3x51 20A	1,50 €
DF 422025	Porselen Sigorta 14.3x51 25A	1,50 €
DF 422032	Porselen Sigorta 14.3x51 32A	1,50 €
DF 422040	Porselen Sigorta 14.3x51 40A	1,50 €
DF 422050	Porselen Sigorta 14.3x51 50A	1,50 €
DF 422063	Porselen Sigorta 14.3x51 63A	1,50 €
DF 422080	Porselen Sigorta 14.3x51 80A	1,50 €
DF 422000	Porselen Sigorta 14.3x51 100A	1,50 €
DF 422015	Porselen Sigorta 14.3x51 125A	1,50 €

NH SİGORTALAR



KOD	CİNSİ	AD. / €
DF 381025	NH C00 gG 500V 16A	4,80 €
DF 381030	NHC00 gG 500V 25A	4,80 €
DF 381035	NH C00 gG 500V 32A	4,80 €
DF 381040	NH C00 gG 500V 35A	4,80 €
DF 381045	NH C00 gG 500V 40A	4,80 €
DF 381050	NH C00 gG 500V A	4,00 €
DF 381055	NH C00 gG 500VA	4,00 €
DF 381060	NH C00 gG 500V 80A	4,00 €
DF 381065	NH C00 gG 500V 100A	4,00 €
DF 381070	NH 00 gG 500V 125A	4,80 €
DF 381075	NH 00 gG 500V 160A	4,80 €
DF 381230	NH C1 gG 500V 50A	12,00 €
DF 381235	NH C1 gG 500V 63A	12,00 €
DF 381240	NH C1 gG 500V 80A	12,00 €
DF 381245	NH C1 gG 500V 100A	12,00 €
DF 381250	NH C1 gG 500V 125A	12,00 €
DF 381255	NH C1 5 gG 500V 160A	12,00 €
DF 381260	NH 1 gG 500V 200A	13,00 €
DF 381270	NH 1 gG 500V 250A	13,00 €
DF 381350	NH C2 gG 500V 200A	20,00 €
DF 381360	NH 2 gG 500V 315A	20,00 €
DF 381370	NH 2 gG 500V 400A	20,00 €

NH ALTLIK



KOD	CİNSİ	AD. / €
DF 354250	NH 1 Altılık CR 250A	16,00 €
DF 354100	NH 00 Altılık 160A Polyester	9,00 €
DF 354400	NH 2 Altılık 400A Polyester	20,00 €
DF 353102	NH 00 3'lü, 160A Poly. (Kapaksız)	20,00 €
DF 334717	NH 00 3'lü, 160A Poly. (Kapaklı)	24,00 €
DF 340001	NH 00-4 Elik	24,00 €

PANO AYDINLATMA İÇİN LEDLİ BANT ARMATÜR



AD. / \$
7,00 \$



Pcb Klemensli, Aç-Kapa Anahtarlı, Mıknatıslı

KOD	WATT	UZUNLUK	FLORESAN AMPUL EŞDEĞERİ	NORMAL AMPUL EŞDEĞERİ	IŞIK AKISI	AD. / \$
EPL-25037	3 W	20 cm	6 W	30 W	270 lm	7,00 \$
EPL-25067	6 W	30 cm	12 W	54 W	540 lm	8,00 \$
EPL-25097	9 W	40 cm	18 W	81 W	810 lm	9,00 \$
EPL-25127	12 W	45 cm	24 W	108 W	1080 lm	10,00 \$
EPL-25157	15 W	55 cm	30 W	135 W	1350 lm	11,00 \$
EPL-25187	18 W	60 cm	36 W	162 W	1620 lm	12,00 \$
EPL-25367	36 W	120 cm	72 W	324 W	3240 lm	20,00 \$

LEDLİ BANT ARMATÜR



120 cm Kablo Çıkışlı

KOD	WATT	UZUNLUK	FLORESAN AMPUL EŞDEĞERİ	NORMAL AMPUL EŞDEĞERİ	IŞIK AKISI	AD. / \$
EPL-15037	3 W	20 cm	6 W	30 W	270 lm	6,00 \$
EPL-15067	6 W	30 cm	12 W	54 W	540 lm	7,00 \$
EPL-15097	9 W	40 cm	18 W	81 W	810 lm	8,00 \$
EPL-15127	12 W	45 cm	24 W	108 W	1080 lm	9,00 \$
EPL-15157	15 W	55 cm	30 W	135 W	1350 lm	10,00 \$
EPL-15187	18 W	60 cm	36 W	162 W	1620 lm	11,00 \$
EPL-15367	36 W	120 cm	72 W	324 W	3240 lm	19,00 \$

HAZIR TESİSAT LEDLİ BANT ARMATÜR



Asansör Kuyu Aydınlatması İçin

KOD	WATT	UZUNLUK	FLORESAN AMPUL EŞDEĞERİ	NORMAL AMPUL EŞDEĞERİ	İŞİK AKISI	AD. / \$
EPL-35037	3 W	20 cm	6 W	30 W	270 lm	7,00 \$
EPL-35067	6 W	30 cm	12 W	54 W	540 lm	8,00 \$
EPL-35097	9 W	40 cm	18 W	81 W	810 lm	9,00 \$
EPL-35127	12 W	45 cm	24 W	108 W	1080 lm	10,00 \$
EPL-35157	15 W	55 cm	30 W	135 W	1350 lm	11,00 \$
EPL-35187	18 W	60 cm	36 W	162 W	1620 lm	12,00 \$
EPL-35367	36 W	120 cm	72 W	324 W	3240 lm	20,00 \$

Asansör kuyu aydınlatması için tasarlanmıştır. Armatürlerin her iki ucunda soket bulunmaktadır. İki ucu soketli ara kablo ile armatürden armatüre atlanarak montaj yapılır.

Ara Kablo

EK-03: 3 m: 2,80 \$

EK-05: 5 m: 3,60 \$

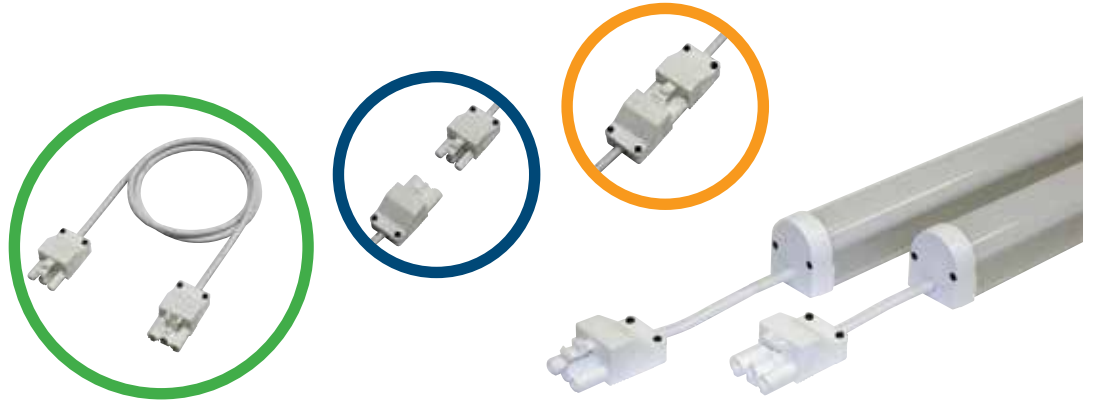

BALIK SIRTİ LEDLİ BANT ARMATÜR



Genel İç Mekan, Kabin, Makina Dairesi, Kuyu Dibi Aydınlatması İçin

KOD	WATT	UZUNLUK	İŞİK AKISI	AD. / \$
EPF-15187	18 W	60 cm	1620 lm	8,00 \$
EPF-15367	36 W	120 cm	3240 lm	9,00 \$

PANO İÇİ LED AYDINLATMA

- Alüminyum Gövde
- Plastik Geçme Ayaklarla Kolay Montaj
- Değişken Ölçülerde ve Voltajlarda Üretim İmkânı
- Aydınlatma Led Tipi ve Farklı Renk Seçenekleri
(Beyaz, Güneşli, Kırmızı, Yeşil, Mavi)

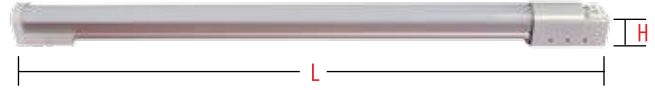
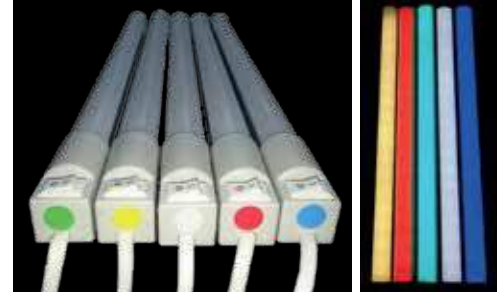

220 / 12 Volt Led Aydınlatma

KOD	ÜRÜN TANIMI	VOLT	BOY ÖLÇÜSÜ	YÜKSEKLİK ÖLÇÜSÜ	KOLİ ADEDİ	AD. / ₺
İR-22025	25 cm Led Pano Aydınlatması	220 Volt	250	23	50	58,50
İR-22035	35 cm Led Pano Aydınlatması	220 Volt	350	23	50	65,00
İR-22045	45 cm Led Pano Aydınlatması	220 Volt	450	23	50	74,00
İR-22055	55 cm Led Pano Aydınlatması	220 Volt	550	23	50	84,50
İR-22060	60 cm Led Pano Aydınlatması	220 Volt	600	23	50	97,50

Voltaj : 110/220 V AC	Güç : 5 W	IP : 20
Frekans: 50/60 Hz.	Renk : Beyaz	

12 Volt Led Aydınlatma

KOD	ÜRÜN TANIMI	VOLT	BOY ÖLÇÜSÜ	YÜKSEKLİK ÖLÇÜSÜ	KOLİ ADEDİ	AD. / ₺
İR-12025	25 cm Led Pano Aydınlatması	12 Volt	250	23	50	52,00
İR-12035	35 cm Led Pano Aydınlatması	12 Volt	350	23	50	54,60
İR-12045	45 cm Led Pano Aydınlatması	12 Volt	450	23	50	57,20
İR-12055	55 cm Led Pano Aydınlatması	12 Volt	550	23	50	67,60
İR-12065	65 cm Led Pano Aydınlatması	12 Volt	650	23	50	78,00

Voltaj : 12 V AC	Renk : Beyaz
Güç : 4 W	IP : 20

24 Volt Led Aydınlatma

KOD	ÜRÜN TANIMI	VOLT	BOY ÖLÇÜSÜ	YÜKSEKLİK ÖLÇÜSÜ	KOLİ ADEDİ	AD. / ₺
İR-24025	25 cm Led Pano Aydınlatması	24 Volt	250	23	50	57,20
İR-24035	35 cm Led Pano Aydınlatması	24 Volt	350	23	50	58,50
İR-24045	45 cm Led Pano Aydınlatması	24 Volt	450	23	50	63,70
İR-24055	55 cm Led Pano Aydınlatması	24 Volt	550	23	50	74,75
İR-24065	65 cm Led Pano Aydınlatması	24 Volt	650	23	50	84,50

Voltaj : 24 V AC	Renk : Beyaz
Güç : 4 W	IP : 20



Ø22 mm SİNYAL LAMBASI LED



KOD	AÇIKLAMA	RENK	AD. / ₺	K. AD.
220 VAC				
ASG-AD22-42220	Ø 22 mm, LED, 220 VAC	Kırmızı	5,00	10
ASG-AD22-31220	Ø 22 mm, LED, 220 VAC	Yeşil	5,00	10
ASG-AD22-51220	Ø 22 mm, LED, 220 VAC	Sarı	5,00	10
ASG-AD22-61220	Ø 22 mm, LED, 220 VAC	Mavi	5,70	10
ASG-AD22-11220	Ø 22 mm, LED, 220 VAC	Beyaz	5,70	10
24 VDC				
ASG-AD22-3124	Ø 22 mm, LED, 24 V DC	Yeşil	5,50	10
ASG-AD22-4224	Ø 22 mm, LED, 24 V DC	Kırmızı	5,50	10
ASG-AD22-5124	Ø 22 mm, LED, 24 V DC	Sarı	5,50	10

Ø 22 mm VOLTMETRELİ SİNYAL LAMBASI LED



KOD	AÇIKLAMA	ÇALIŞMA ARALIĞI	RENK	AD. / ₺	K. AD.
AD22VM-42220	Ø 22 mm, LED, 220 VAC	50-500 VAC	Kırmızı	28,00	10
AD22VM-31220	Ø 22 mm, LED, 220 VAC	50-500 VAC	Yeşil	28,00	10
AD22VM-51220	Ø 22 mm, LED, 220 VAC	50-500 VAC	Sarı	28,00	10

Ø 10 mm SİNYAL LAMBASI LED 220V



KOD	AÇIKLAMA	RENK	AD. / ₺	K. AD.
AD10-31220	Ø 10 mm, LED, 220 VAC	Kırmızı	2,80	10
AD10-42220	Ø 10 mm, LED, 220 VAC	Yeşil	2,80	10
AD10-51220	Ø 10 mm, LED, 220 VAC	Sarı	2,80	10

Ø 22 mm SİNYAL LAMBASI LED (BUTON TİPİ)



KOD	AÇIKLAMA	AD. / ₺	K. AD.
AD22-EW5112 (Sarı Renk)	Ø 22 mm, BA9S LED, 12 V DC	23,00	10

İKAZ LAMBASI v110 dB (Montaj Ayaklı)



KOD	AÇIKLAMA	AD. / ₺	K. AD.
1082J-L (Kırmızı Renk)	Sesli Led Flaşör İkazlı 24 VDC	150,00	10

BUZZERLER (Ø 22 mm LED'li Buzzer 90 dB)



KOD	RENK	CİNSİ	AD. / ₺	K. / AD.
AD22-220SM/R	●	Ø 22 mm Sesli-Led Flaşör İkazlı 220 V AC	20,00	10
AD22-24SM/R	●	Ø 22 mm Sesli-Led Flaşör İkazlı 24 V AC-DC	20,00	10

SİRENLER



KOD	RENK	CİNSİ	AD. / ₺	K. AD.
Ø 50 mm Siren (120 dB)				
PS-101,12-24 V	●	Siren 12 - 24 V AC/DC Plastik Gövde	29,00	1
PS-101, 220 V	●	Siren 220V AC Plastik Gövde	32,00	1
ES-220, 12 V	●	Siren 12V DC Plastik Gövde	32,00	1
Ø 75 mm Motorlu Siren (110 dB)				
MS-190	●	Motorlu Siren 220 V AC Metal Gövde	85,00	1

LAY5 SERİSİ (Ø22 mm Butonlar)

YAYLI BUTON 3A / 240 V AC, IP 44

PLASTİK BUTON SERİSİ



KOD	RENK	AÇIKLAMA	KONTAK	AD./ç	K. AD.
LAY5-EA31	●	Start Buton	NO	8,40	20
LAY5-EA42	●	Stop Buton	NC	8,40	20
LAY5-EA51	●	Start Buton	NO	8,40	20
LAY5-EA61	●	Start Buton	NO	8,40	20
LAY5-EA21	●	Start Buton	NO	8,40	20
LAY5-EA2351	⚠	Start Buton	NO	8,90	20
LAY5-EA7321	⚠	Start Buton	NO	8,90	20
LAY5-EA3341	⬆	Start Buton	NO	8,90	20
LAY5-EA3351	⬇	Start Buton	NO	8,90	20
LAY5-EA6361	⬆	Start Ortak Buton	NO	8,90	20
LAY5-EL8325	■ ■	Start Stop İkiz Buton	NO+NC	17,50	20
LAY5-EL3371	⬆ ⬇	Start İkiz Buton Oklu	NO+NO	18,80	20

METAL BUTON SERİSİ

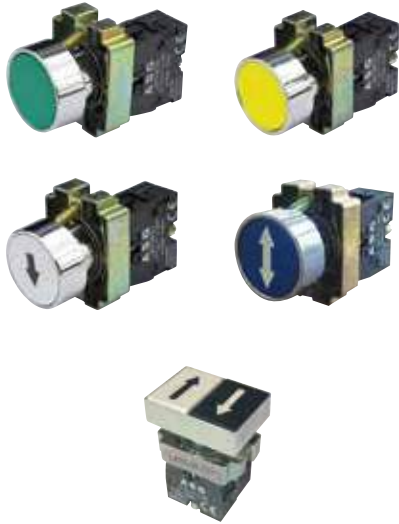

KOD	RENK	AÇIKLAMA	KONTAK	AD./ç	K. AD.
LAY5-BA31	●	Start Buton	NO	11,50	20
LAY5-BA42	●	Stop Buton	NC	11,50	20
LAY5-BA51	●	Start Buton	NO	11,50	20
LAY5-BA61	●	Start Buton	NO	11,50	20
LAY5-BA21	●	Start Buton	NO	11,50	20
LAY5-BA2351	⚠	Start Buton	NO	12,50	20
LAY5-BA7321	⚠	Start Buton	NO	12,50	20
LAY5-BA3341	⬆	Start Buton	NO	12,50	20
LAY5-BA3351	⬇	Start Buton	NO	12,50	20
LAY5-BA6361	⬆	Start Ortak Buton	NO	12,50	20
LAY5-BL8325	■ ■	Start Stop İkiz Buton	NO	24,00	20
LAY5-BL3371	⬆ ⬇	Start İkiz Buton Oklu	NO+NO	25,00	20

LAY5 SERİSİ (Ø22 mm Butonlar)

PLASTİK BUTON SERİSİ



MANTAR BUTON 3A / 240 V AC, IP 44

KOD	AÇIKLAMA	KONTAK	AD./ç	K. AD.
LAY5-ES542	Acil Stop Buton Kırmızı	NC	12,50	20



MANDAL BUTON 3A / 240 V AC, IP 44

KOD	AÇIKLAMA	KONTAK	AD./ç	K. AD.
LAY5-EJ21	Mandal Buton Uzun 0-1	NO	10,00	20
LAY5-ED21	Mandal Buton Kısa 0-1	NO	10,00	20
LAY5-ED33	Mandal Buton Kısa 1-0-2	2 NO	14,00	20

METAL BUTON SERİSİ



MANTAR BUTON 3A / 240 V AC, IP 44

KOD	AÇIKLAMA	KONTAK	AD./ç	K. AD.
LAY5-BS542	Acil Stop Buton Kırmızı	NC	16,00	20



MANDAL BUTON 3A / 240 V AC, IP 44

KOD	AÇIKLAMA	KONTAK	AD./ç	K. AD.
LAY5-BJ21	Mandal Buton Uzun 0-1	NO	13,00	20
LAY5-BD21	Mandal Buton Kısa 0-1	NO	13,00	20
LAY5-BD33	Mandal Buton Kısa 1-0-2	2 NO	17,00	20

LAY5 SERİSİ (Ø22 mm Butonlar)



YEDEK KONTAK 3A / 240 V AC, IP 44

KOD	AÇIKLAMA	AD. / ʈ	K. AD.
LAY5-BE101	Kontakt Bloğu NO	4,00	150
LAY5-BE102	Kontakt Bloğu NC	4,00	150

ANAHTARLI BUTON 3A / 240 V AC, IP 44

KOD	AÇIKLAMA	KONTAK	AD. / ʈ	K. AD.
LAY5-BG21	Anahtarlı Buton 0-1	NO	24,50	20
LAY5-BG73	Anahtarlı Buton 1-0-2 Sağa-Sola Kayıcı	2NO	30,00	20

LAY5 SERİSİ 4'LÜ KUMANDA KUTUSU (Asansörler İçin)



KOD	AÇIKLAMA	AD. / ʈ	K. AD.
LAY5-EJ140 Pastik Butonlu Miknatis Tabanlı	ES542 Stop (NC Kontakt), Stop Buton Muhafazası, EA3341 Start Buton Siyah oklu (NO Kontakt), EA3351 Start Buton Beyaz oklu (NO Kontakt), EJ25 0-1 Mandal Buton (NO+NC Kontakt), PG 13.5 kablo rekor, serigraf (İngilizce - Türkçe) yazı, Mandal Buton Muhafazası, Miknatis Tabanlı	74,00	30
LAY5-BJ141 Metal Butonlu Miknatis Tabanlı	BS542 Stop (NC Kontakt), Stop Buton Muhafazası, BA3341 Start Buton Siyah oklu (NO Kontakt), BA3351 Start Buton Beyaz oklu (NO Kontakt), BJ25 0-1 Mandal Buton (NO+NC Kontakt), PG 13.5 kablo rekor, serigraf (İngilizce - Türkçe) yazı, Mandal Buton Muhafazası, Miknatis Tabanlı	87,00	30

LAY5 SERİSİ 5'Lİ KUMANDA KUTUSU (Asansörler İçin)



KOD	AÇIKLAMA	AD. / ʈ	K. AD.
LAY5-EJ151 Pastik Butonlu Miknatis Tabanlı	ES542 Stop (NC Kontakt), Stop Buton Muhafazası, EA3341 Start Buton Siyah oklu (NO Kontakt), EA6361 Start Ortak Buton Beyaz oklu (NO Kontakt), EA3351 Start Buton Beyaz oklu (NO Kontakt), EJ25 0-1 Mandal Buton (NO+NC Kontakt), PG 13.5 kablo rekor, serigraf (İngilizce - Türkçe) yazı, Mandal Buton Muhafazası, Miknatis Tabanlı	86,00	30
LAY5-BJ151 Metal Butonlu Miknatis Tabanlı	BS542 Stop (NC Kontakt), Stop Buton Muhafazası, BA3341 Start Buton Siyah oklu (NO Kontakt), BA6361 Start Ortak Buton Beyaz oklu (NO Kontakt), BA3351 Start Buton Beyaz oklu (NO Kontakt), BJ25 0-1 Mandal Buton (NO+NC Kontakt), PG 13.5 kablo rekor, serigraf (İngilizce - Türkçe) yazı, Mandal Buton Muhafazası, Miknatis Tabanlı	104,00	30

LAY5 SERİSİ 6'Lİ KUMANDA KUTUSU (Asansörler İçin)



KOD	AÇIKLAMA	AD. / ʈ	K. AD.
LAY5-EJ1451 Pastik Butonlu Miknatis Tabanlı	ES542 Stop (NC Kontakt), Stop Buton Muhafazası, EA51 Start Alarm Buton (NO Kontakt), EL3371 İkiz Start Oklu Buton (Siyah Oklu, NO Kontakt + Beyaz Oklu, NO Kontakt), EA6361 Start Ortak Buton Beyaz oklu (NO Kontakt), EJ25 0-1 Mandal Buton (NO+NC Kontakt), PG 13.5 Kablo Rakor, Serigraf (İngilizce - Türkçe) Yazı, Mandal Buton Muhafazası, Miknatis Tabanlı	95,00	30
ES542W	ES542 Stop Butonu, ES542W Pencere Stop Butonu Olarak İstenirse	100,00	30
LAY5-BJ1451 Metal Butonlu Miknatis Tabanlı	BS542 Stop (NC Kontakt), Stop Buton Muhafazası, BA51 Start Alarm Buton (NO Kontakt), BL3371 İkiz Start Oklu Buton (Siyah Oklu, NO Kontakt + Beyaz Oklu, NO Kontakt), BA6361 Start Ortak Buton Beyaz oklu (NO Kontakt), BJ25 0-1 Mandal Buton (NO+NC Kontakt), PG 13.5 Kablo Rakor, Serigraf (İngilizce - Türkçe) Yazı, Mandal Buton Muhafazası, Miknatis Tabanlı	115,00	30

LAYS SERİSİ TEKLİ KUMANDA KUTUSU



KOD	AÇIKLAMA	KONTAK	AD. / ₺	K. AD.
LAY5-J174H29	Emergency stop etiketli	NC	23,00	100
LAY5-JHEA51	1'li boş kutuya monte alarm butonu	NO	19,00	100
LAY5-JHED21	1'li boş kutuya monte 0-1 Mandal Buton	NO	22,00	100
LAY5-JHBD21	1'li boş kutuya monte 0-1 Mandal Buton - Metal Gövde	NO	26,00	100
LAY5-JHEL3371	1'li boş kutuya monte Yukarı - Aşağı Oklu İkiz Buton	2NO	32,00	100

LAYS SERİSİ TEKLİ KUMANDA KUTUSU



KOD	AÇIKLAMA	KONTAK	AD. / ₺	K. AD.
LAY5-J174H29P	Emergency stop muhafazalı	NC	24,00	100
LAY5-JH-BX1PMB	Emergency stop muhafazalı (EN60947-5-5 Standardı)	NC	46,00	100
LAY5-JHEA21	1'li boş kutuya monte aydınlatma butonu	NO	19,50	100
LAY5-JHEG61	1'li boş kutuya monte kuyu dışından revizyon reset anahtar	NO	35,00	100
LAY5-JHBG61	1'li boş kutuya monte kuyu dışından revizyon reset anahtar Metal Gövde	NO	40,00	100
LAY5-JH24SM/R	1'li boş kutuya monte 24VDC Bypass buzzer	NO	28,00	100
LAY5-JHBA21	1'li boş kutuya monte aydınlatma butonu - Metal Gövde	NO	25,00	100

LAY5-BX SERİSİ BOŞ KUTULAR



KOD	AÇIKLAMA	AD. / ʘ	K. AD.
LAY5-JBX1	1'li Sarı Siyah Boş Kutu	10,00	100
LAY5-BX1	1'li Beyaz Siyah Boş Kutu	10,00	100
LAY5-BX2	2'li Beyaz Siyah Boş Kutu	15,00	100
LAY5-BX3	3'lü Beyaz Siyah Boş Kutu	19,00	100
LAY5-JBX1P	1'li Sarı Siyah Boş Kutu Muhafazalı	13,00	100
LAY5-JBX01	1'li Sarı Siyah Boş Kutu	11,00	100

LAY5-HBX SERİSİ BOŞ KUTULAR (YÜKSEK TİP)

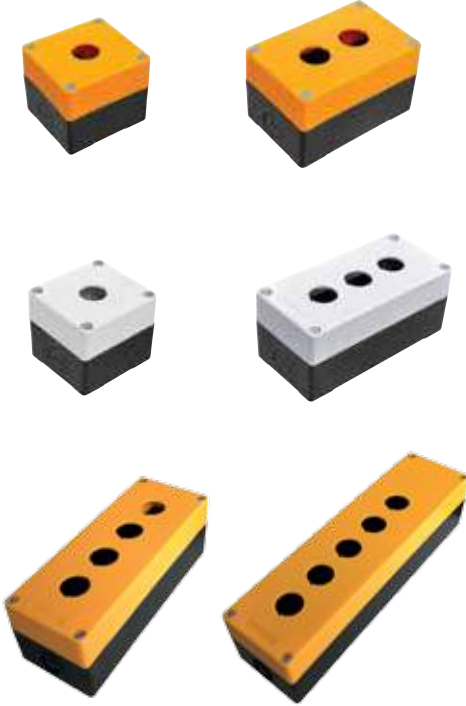

KOD	AÇIKLAMA	AD. / ʘ	K. AD.
LAY5-HBX1	1'li Beyaz Siyah Boş Kutu	9,50	100
LAY5-HBX2	2'li Beyaz Siyah Boş Kutu	13,50	100
LAY5-HBX3	3'lü Beyaz Siyah Boş Kutu	16,50	75
LAY5-HBX4	4'lü Beyaz Siyah Boş Kutu	19,50	50
LAY5-JHBX1	1'li Sarı Siyah Boş Kutu	9,50	100
LAY5-JHBX2	2'li Sarı Siyah Boş Kutu	13,50	100
LAY5-JHBX3	3'lü Sarı Siyah Boş Kutu	16,50	75
LAY5-JHBX4	4'lü Sarı Siyah Boş Kutu	19,50	50
LAY5-JHBX5	5'li Sarı Siyah Boş Kutu	26,00	50
LAY5-JHBX6	6'lı Sarı Siyah Boş Kutu	28,00	50

LAY5-JBH SERİSİ PAKO ve BUTON KUTULARI

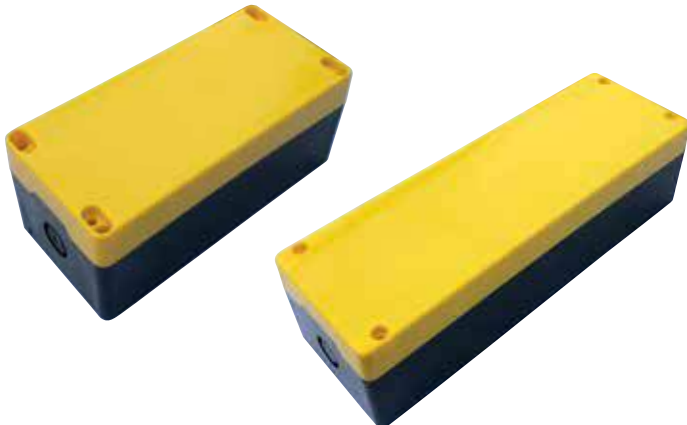

KOD	AÇIKLAMA	K. AD.	AD. / ʘ
LAY5-JBH4Y	4'lü Sarı - Siyah Pako ve Buton Kutusu G: 80 mm Y: 73 mm U: 170 mm	50	26,00
LAY5-JBH6Y	6'li Sarı - Siyah Pako ve Buton Kutusu G: 88 mm Y: 73 mm U: 262 mm	20	40,00

ACIL STOP ETİKLERİ



KOD	AÇIKLAMA	AD. / ₺	K. AD.
ES60L	Ø 60 mm Leksan Baskılı Acil Stop	5,00	100
ES60P	Plastik Emergency Stop	5,00	100

YAYLI BUTON KORUMA KILIF VE KAPAKLARI



P46



P45



P45N



P48



P47



AP2

KOD	AÇIKLAMA	AD. / ₺	K. AD.
P46	Stop buton için muhafaza	4,30	20
P45	Mandal buton için muhafaza	5,00	18
P45N	Mandal buton için muhafaza	4,50	18
P47	Start ve mandal buton için kilitli muhafaza	10,00	12
AKK	Stop buton için muhafaza	5,00	20
AP2	IP67 Buton Koruma Kılıfı	3,50	20
P48	Start, mandal ve mantar buton için kilitli muhafaza	11,00	10

BUTON KUTUSU KÖR TAPA



KOD	AÇIKLAMA	AD. / ₺	KUTU AD.
KT22	Buton kutusu için 22 mm. kör tapa	2,30	100

LİMİT SWITCH



KOD	AÇIKLAMA	AD. / ₺	K. AD.
CLS-191	Ø 50 mm Makara, Ayarlanabilir (Her Yöne) Metal Kol, Plastik Gövde	37,00	50
CLS-191R	Ø 50 mm Makara, Ayarlanabilir (Her Yöne) Metal Kol, Resetli, Plastik Gövde	45,00	50
CLS-191A	Ø 50 mm Makara, Ayarlanabilir (Her Yöne) Metal Kol (İleri Geri Ayarlanabilir), Plastik Gövde	40,00	50
CLS-103	Doğrusal Hareketli, 11 mm Metal Makaralı Pim	32,00	10
CLS-103R	Resetli Dikey Pim Makara Ø 12 Metal	35,00	10

MİNİ SWITCH

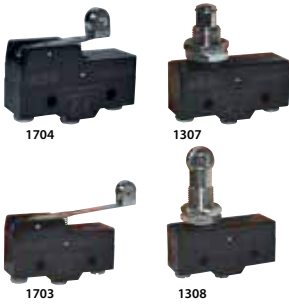

KOD	AÇIKLAMA	AD. / ₺	K. AD.
CM1704 (XZ-15GW22-B)	Kısa Palet Metal Makaralı	27,00	20
CM1703 (XZ-15GW22-B)	Uzun Palet Metal Makaralı	27,00	20
CM1307 (XZ-15GQ-B)	Kalın Uzun Pimli	29,00	20
CM1308 (XZ-15GQ-B)	Düz Makaralı Pim	30,00	20

ASANSÖRLER İÇİN MİKNATISLAR

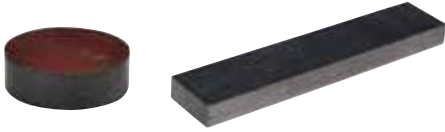

KOD	AÇIKLAMA	AD. / ₺	K. AD.
22x7	22 mm Çap, 7 mm Yükseklik, Kırmızı Boyalı Yuvarlak Mıknatıs	0,57	1500
10 cm Şerit Mıknatıs	20 mm en, 8 mm Yükseklik, Şerit Mıknatıs	2,50	360
30 cm Şerit Mıknatıs	20 mm en, 8 mm Yükseklik, Şerit Mıknatıs	7,20	120

EL KUMANDA KUTULARI İÇİN MİKNATISLAR



KOD	AÇIKLAMA	AD. / ₺	K. AD.
13,5 cm Mıknatıs	135 mm boy, 55 mm en, 2 mm yükseklik (3M Yapıştırıcı Kutu Altı Mıknatıs)	3,50	100
16,8 cm Mıknatıs	168 mm boy, 49 mm en, 2 mm yükseklik (3M Yapıştırıcı Kutu Altı Mıknatıs)	4,50	100

HOPARLÖR



KOD	AÇIKLAMA	AD. / ₺	K. AD.
SP-50 / 0.5 w	50 mm Çap, 8 ohm 0.5 W Hoparlör	8,70	100
SP-57 / 0.5 w	57 mm Çap, 8 ohm 0.5 W Hoparlör	9,70	100
SP-57 / 1 w	57 mm Çap, 8 ohm 1 W Hoparlör	10,50	100
SP-77 / 1 w	77 mm Çap, 8 ohm 1 W Hoparlör	12,50	100
SP-9050	8 ohm 5 W Hoparlör	28,00	100

KÖPRÜ DİYOT



KOD	AÇIKLAMA	AD. / ₺	K. AD.
KBPC-3510	35 A / 1000 V	10,00	50
KBPC-5010	50 A / 1000 V	17,00	50

ASANSÖR KUYU DİBİ ALARM SETLERİ



KOD	AÇIKLAMA	AD. / ₺	K. AD.
AS9V	1'li boş kutuya monte, Alarm seti, 110 dB 12V DC siren, 9 V Pil+ Soket	60,00	1
AS220V	1'li boş kutuya monte, Alarm seti, 110 dB 220V siren	60,00	1
SP2	2'li boş kutuya monte, 220 V 16 A Topraklı priz, ES542 Stop (NC)	50,00	1
SMP3	3'lü boş kutuya monte, 220 V 16 A Topraklı priz, ES542 Stop (NC), EJ21 0-1 Mandal(NO+NC)	70,00	1
SAMP4	4'lü boş kutu, 220 V 16 A Topraklı priz, ES542 Stop (NC), EJ21 0-1 Mandal(NO+NC), EA51 Buton (NO)	80,00	1
SAMP9V	5'li boş kutu, 220 V 16 A Topraklı priz, ES542 Stop (NC), EJ21 0-1 Mandal(NO+NC), EA51 Buton (NO), 110 dB 12V DC siren, 9 V Pil+ Soket	150,00	1
SAMP220V	SAMP Kutu + 110 dB 220V Siren	150,00	1

ASANSÖR KUYU DİBİ MUAYENE İSTASYONU

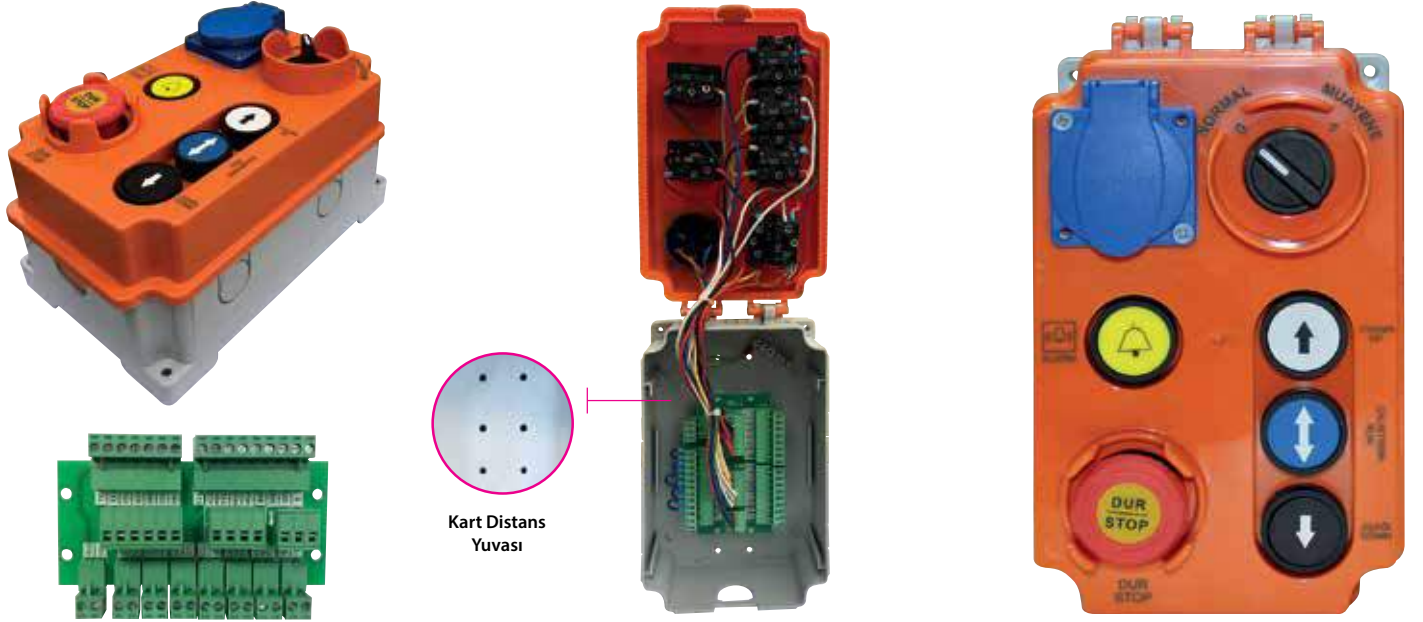

KDKK1

KOD	AÇIKLAMA	AD. / ₺	K. AD.
KD701 (TİP2 KUTU)	ES542 Stop (NC Kontakt) EA3341 Start Buton Siyah oklu (NO Kontakt), EA6361 Start Ortak Buton Beyaz oklu (NO Kontakt), EA3351 Start Buton Beyaz oklu (NO Kontakt), EA2351 Alarm Sembollü Start Buton (NO Kontakt) EJ25 0-1 Mandal Buton (NO+NC Kontakt), 1x16A Priz, serigraf Türkçe yazı	170,00	1
KDK702 (TİP2 KUTU)	ES542 Stop (NC Kontakt) EA3341 Start Buton Siyah oklu (2NO Kontakt), EA6361 Start Ortak Buton Beyaz oklu (2NO Kontakt), EA3351 Start Buton Beyaz oklu (2NO Kontakt), EA2351 Alarm Sembollü Start Buton (NO Kontakt) EJ25 0-1 Mandal Buton (1NO+2NC Kontakt), 1x16A Priz, serigraf Türkçe yazı 5'li Topraklama Klemensi ve Kuyudibi Klemens Kartı Örülmüş Olarak	320,00	1
KDKK1	Kuyudibi Muayene istasyonu klemens kartı	70,00	1



1 Kontak 5 Pin Minyatür Röle (İğne Bacaklı) 10A

KOD	AÇIKLAMA	KUTU AD.	AD. / ₺
JQX-14FC-1Z-24V	1 Kontak, 5 Pin Minyatür Röle, İğne Bacaklı 24 V DC	100	20,00
JQX-14FC-1Z-220V	1 Kontak, 5 Pin Minyatür Röle, İğne Bacaklı 220 V AC	100	42,00



5 Pin Röle Soketi

KOD	AÇIKLAMA	KUTU AD.	AD. / ₺
14F-1Z-C2	5 Pin Tek Kontak Röle Soketi Kısa, Raya Montaj	20	18,00



2 Kontak 8 Pin Minyatür Röle (İğne Bacaklı) 5A

KOD	AÇIKLAMA	KUTU AD.	AD. / ₺
JQX-14FC-1Z-12V	2 Kontak, 8 Pin Minyatür Röle, İğne Bacaklı 12 V DC	100	20,00
JQX-14FC-2Z-24V	2 Kontak, 8 Pin Minyatür Röle, İğne Bacaklı 24 V DC	100	20,00
JQX-14FC-2Z-220V	2 Kontak, 8 Pin Minyatür Röle, İğne Bacaklı 220 V AC	100	42,00

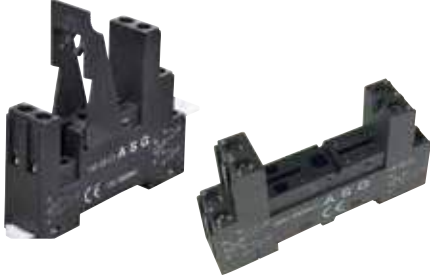

8 Pin Röle Soketi

KOD	AÇIKLAMA	KUTU AD.	AD. / ₺
14F-2Z-C2	8 Pin Çift Kontak Röle Soketi Kısa, Raya Montaj	20	18,00
14F-2Z-C3	8 Pin Çift Kontak Röle Soketi, Raya Montaj Röle Tutucu	20	19,00



2 Kontak 8 Pin (Yuvarlak Pin) Endüstriyel Tip Röle (LED'li ve T.Butonlu) 10A

KOD	AÇIKLAMA	KUTU AD.	AD. / ₺
MK2P 220V AC	2 Kontak 8 Pin Röle 220V AC	100	55,00
60.2 220V AC	2 Kontak 8 Pin Röle 220V AC	100	60,00



8 Pin Röle Soketi

KOD	AÇIKLAMA	KUTU AD.	AD. / ₺
AS760	8 Pin 2 Kontak Röle Soketi	100	21,00

2 KUTUPLU KAÇAK AKIM KORUMA RÖLESİ



KOD	KUTUP SAYISI	ANMA AKIMI (A)	ANMA KAÇAK İLETME AKIMI	KESME KAPASİTESİ	ANMA GERİLİMİ	KUTU AD.	AD./₺
RNR3-63	1P + N	25 A	30 mA	6 kA	240 V	1	103,00

4 KUTUPLU KAÇAK AKIM KORUMA RÖLESİ



KOD	KUTUP SAYISI	ANMA AKIMI (A)	ANMA KAÇAK İLETME AKIMI	ANMA GERİLİMİ	KUTU AD.	AD./₺
RNR3-63	3P + N	40 A	30 mA	415 V	1	150,00
RNR3-63	3P + N	63 A	30 mA	415 V	1	155,00

1 KUTUPLU OTOMATİK SİGORTALAR (C TİPİ)

3 kA Kesme Kapasiteli



KOD	KUTUP SAYISI	ANMA AKIMI (A)	ANMA GERİLİMİ	KUTU AD.	AD./₺
RNM1-63	1P	2 A	230/400 V	12	18,00
RNM1-63	1P	4 A	230/400 V	12	18,00
RNM1-63	1P	6 A	230/400 V	12	15,30
RNM1-63	1P	10 A	230/400 V	12	15,30
RNM1-63	1P	16 A	230/400 V	12	15,30

3 KUTUPLU OTOMATİK SİGORTALAR (C TİPİ)

3 kA Kesme Kapasiteli



KOD	KUTUP SAYISI	ANMA AKIMI (A)	ANMA GERİLİMİ	KUTU AD.	AD./₺
RNM1-63	3P	25 A	400 V	4	53,00
RNM1-63	3P	32 A	400 V	4	57,00
RNM1-63	3P	40 A	400 V	4	60,00

4 KUTUPLU OTOMATİK SİGORTALAR (C TİPİ)

3 kA Kesme Kapasiteli



KOD	KUTUP SAYISI	ANMA AKIMI (A)	ANMA GERİLİMİ	KUTU AD.	AD./₺
RNM1-63	4P	40 A	400 V	3	75,00
RNM1-63	4P	63 A	400 V	3	80,00

DARBE AKIM ŞALTERİ



KOD	KUTUP SAYISI	ANMA AKIMI (A)	KONTAKT SAYISI	ANMA GERİLİMİ	KUTU AD.	AD./₺
BIR-16	1P	16 A	1 NO	230 V	12	77,00



3 KA 2 KUTUPLU ve 4 KUTUPLU
KAÇAK AKIM RÖLELERİ

AC GÜÇ KONTAKTÖRLERİ - AC 220 V BOBİNLİ



KOD	ANMA AKIMI (A)	ANMA GÜCÜ (A) 380 V AC (kW)	TERMİK AKIM (Ith) (A)	Y. KONTAK NA - NK	KUTU AD.	AD./ç
SMC1-22	22 A	11 kW	40 A	1 1	60	110,00
SMC1-32	32 A	15 kW	50 A	2 2	40	180,00
SMC1-40	40 A	18.5 kW	60 A	2 2	40	200,00

YARDIMCI KONTAK BLOKLARI



KOD	MONTAJ	KONTAK	KUTU AD.	AD./ç
AU-11	Üst	1 NO + 1 NC	40	24,00
AU-22	Üst	2 NO + 2 NC	20	38,00
KOD	MONTAJ	KONTAK	KUTU AD.	AD./ç
LA1-DN11	Üst	1 NO + 1 NC	400	18,00
LA1-DN22	Üst	2 NO + 2 NC	250	30,00

TERMİK RÖLELER (Kontaktöre Montaj)



KOD	TERMİK AYAR SAHASI	BİRLİKTE KULLANILAN KONTAKTÖR TİPİ	KUTU AD.	AD./ç
UKH-22,7-10A	7 - 10 A	SMC1 9 - 40	120	60,00
UKH-22,9-13A	9 - 13 A	SMC1 9 - 40	120	60,00
KOD	TERMİK AYAR SAHASI	KUTU AD.	AD./ç	
JR28 5.5-8A	5.5 - 8 A	100	60,00	
JR28 7-10A	7 - 10 A	100	60,00	
JR28 9-13A	9 - 13 A	100	60,00	
JR28 12-18A	12 - 18 A	100	60,00	

TERMİK RÖLELER (Raya Montaj)



KOD	TERMİK AYAR SAHASI	KUTU AD.	AD./ç
JRS2 6.3-10A	6.3 - 10 A	50	85,00
JRS2 10-16A	10 - 16 A	50	85,00
JRS2 16-25A	16 - 25 A	50	85,00

KUMANDA KUTU ve VİNÇ KUMANDA KUTULARI

📞 FİYAT SORUNUZ

EMAS®



KUMANDA BUTONLARI VE SİNYAL LAMBALARI

PEDALLAR



SINIR ŞALTERLERİ

ASAL SWITCHLER



GÜVENLİK GRUBU ÜRÜNLERİ

MOTOR KORUMA ŞALTERLERİ



AÇMA KAPAMA ŞALTERLERİ



OPAS



**FİYAT
SORUNUZ**

KADEMELİ ŞALTERLER



KUTUP DEĞİŞTİRİCİ ŞALTERLER



AYIRICI KESİCİ ŞALTERLER

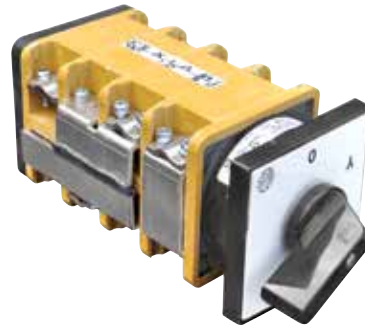

MOTOR KUMANDA ŞALTERLERİ

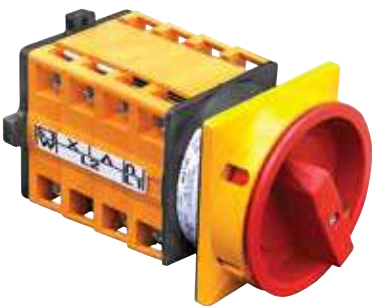

ÖLÇME KOMİTATÖRLERİ



OTOMATİK POMPA KONTROL CİHAZLARI



KOD	AÇIKLAMA	BAĞLANTI	K. AD.	AD. / \$
ELT PCA	Dikey Çıkışlı, Önden Ayarlı, Manometreli, Kablolu	1	12	32,00 \$
ELT PCAF	Dikey Çıkışlı, Önden Ayarlı, Manometreli, Kablolu Fişli	1	12	33,00 \$
ELT PCAT	Tanklı Dikey Çıkışlı, Önden Ayarlı, Manometreli, Kablolu	1	12	58,00 \$
ELT PCATF	Tanklı Dikey Çıkışlı, Önden Ayarlı, Manometreli, Kablolu, Fişli	1	12	59,00 \$
ELT PC1	Dikey Çıkışlı, Arkadan Ayarlı, Manometreli, Kablosuz	1	12	28,00 \$
ELT PC1-C	Dikey Çıkışlı, Manometreli, Kablolu, Arka Gövdeden Ayarlı	1	12	30,00 \$
ELT PC1-CS	Dikey Çıkışlı, Manometreli, Kablolu, Prizli, Arka Gövdeden Ayarlı	1	12	32,00 \$
ELT PC2	Yatay Çıkışlı, Manometreli, Kablosuz, Arka Gövdeden Ayarlı	1	12	28,00 \$
ELT PC2-C	Yatay Çıkışlı, Manometreli, Kablolu, Arka Gövdeden Ayarlı	1	12	30,00 \$
ELT PC2-CS	Yatay Çıkışlı, Manometreli, Kablolu, Prizli, Arka Gövdeden Ayarlı	1	12	32,00 \$
ELT PC-K	Otomatik Pompa Kontrolü Elektronik Kartı			10,00 \$

PRESOSTATLAR



KOD	AÇIKLAMA	BASINÇ ARALIĞI BAR	AD. / ₺
ELEM-ELT 35	0.6 BAR / 3.0 BAR	-02 / 8	95,00
ELEM-ELT 36	1.0 BAR / 3.5 BAR	5 / 16	95,00
ELEM-ELT 37	2.0 BAR / 10 BAR	5 / 28	128,00
ELEM-ELT 38	2.0 BAR / 15 BAR	5 / 50	211,00

MONOFAZE BASINÇ ŞALTERLERİ



KOD	AÇIKLAMA	DİFERANS ARALIĞI BAR	AD. / ₺
ELEM-ELT 5	1-6 Bar Tahliyesiz	9.2 / 2.5	38,00
ELEM-ELT 5C	1-6 Bar Tahliyelili	1.2 / 2.8	40,00
ELEM-ELT 5CO	1-6 Bar Tahliyelili ON - OFF	1.2 / 2.8	41,50
ELEM-ELT 5C-3Y	1-6 Bar Tahliyelili ON - OFF	1.2 / 2.8	43,00
ELEM-ELT 5CO-3Y	1-6 Bar Tahliyelili Üç Yollu ON - OFF	1.2 / 2.8	44,50
ELEM-ELT 6	2-11 Bar Tahliyesiz	1.3 / 3.5	40,00
ELEM-ELT 6C	2-11 Bar Tahliyelili	1.3 / 3.8	41,50
ELEM-ELT 6CO	2-11 Bar Tahliyelili ON-OFF	1.3 / 3.5	43,00
ELEM-ELT 6C-3Y	2-11 Bar Tahliyelili ÜÇ YOLLU	1.3 / 3.8	44,50
ELEM-ELT 6CO-3Y	2-11 Bar Tahliyelili Üç Yollu ON-OFF	1.3 / 3.8	45,50

TRİFAZE BASINÇ ŞALTERLERİ



KOD	AÇIKLAMA	DİFERANS ARALIĞI BAR	AD. / ₺
ELEM-ELT 2	2-8 Bar Tahliyesiz	0.9 / 4.7	45,50
ELEM-ELT 2C	2-8 Bar Tahliyelili	1.2 / 5.0	50,00
ELEM-ELT 2CO	2-8 Bar Tahliyelili ON - OFF	1.2 / 5.0	51,00
ELEM-ELT 2C-3Y	2-8 Bar Tahliyelili Üç Yollu	1.2 / 5.0	54,00
ELEM-ELT 2CO-3Y	2-8 Bar Tahliyelili Üç Yollu ON - OFF	1.2 / 5.0	55,00
ELEM-ELT 3	3-11 Bar Tahliyesiz	1.2 / 5.3	45,50
ELEM-ELT 3C	23-11 Bar Tahliyesiz	1.5 / 5.6	50,00
ELEM-ELT 3CO	3-11 Bar Tahliyelili ON - OFF	1.5 / 5.6	51,00
ELEM-ELT 3C-3Y	3-11 Bar Tahliyelili Üç Yollu	1.5 / 5.6	54,00
ELEM-ELT 3CO-3Y	3-11 Bar Tahliyelili Üç Yollu ON - OFF	1.5 / 5.6	55,00
ELEM-ELT 4	4-16 Bar Tahliyesiz	1.8 / 7.5	45,50
ELEM-ELT 4C	4-16 Bar Tahliyelili	2.1 / 7.8	50,00
ELEM-ELT 4CO	4-16 Bar Tahliyelili ON - OFF	2.1 / 7.8	51,00
ELEM-ELT 4C-3Y	4-16 Bar Tahliyelili Üç Yollu	2.1 / 7.8	54,00
ELEM-ELT 4CO-3Y	4-16 Bar Tahliyelili Üç Yollu ON - OFF	2.1 / 7.8	55,00

SU SEVİYE FLATÖRLERİ (TTR) KABLOLU



KOD	AÇIKLAMA	AD. / ʘ	K. / AD.
ELEM-FTE 60 K2	ELT 0.60 m. Kauçuk	25,50	80
ELEM-FTE 60 T1	ELT 0.60 m. TTR	22,50	80
ELEM-FTE 60 T2	ELT 0.60 m. TTR	23,50	80
ELEM-FTE160	ELT 1.6 m. Flatör	31,00	30
ELEM-FTE 300	ELT 3 m. Flatör	34,50	30
ELEM-FTE 500	ELT 5 m. Flatör	44,00	25
ELEM-FTE 1000	ELT 10 m. Flatör	74,50	20
ELEM-FTE 1500	ELT 15 m. Flatör	104,00	15

SU SEVİYE FLATÖRLERİ (NMJ KAUCUK) KABLOLU



KOD	AÇIKLAMA	AD. / ʘ	K. / AD.
ELEM-FTE 160K	ELT 1.6 m. Flatör	38,50	30
ELEM-FTE 300K	ELT 3 m. Flatör	43,50	30
ELEM-FTE 500K	ELT 5 m. Flatör	62,00	25
ELEM-FTE 1000K	ELT 10 m. Flatör	116,00	20
ELEM-FTE 1500K	ELT 15 m. Flatör	167,00	15

90° ATIK SIVI SEVİYE FLATÖRLERİ



(A. Atık Sıvı Seviye Flatörü 90°)

KOD	AÇIKLAMA	AD. / ʘ	K. / AD.
ELEM-FTE 300A	3 m. Flatör	87,00	25
ELEM-FTE 500A	5 m. Flatör	96,50	20
ELEM-FTE1000A	10 m. Flatör	133,00	15
ELEM-FTE 1500A	15 m. Flatör	174,00	15
ELEM-FTE 2000A	20 m. Flatör	197,00	10

40° ATIK SIVI SEVİYE FLATÖRLERİ



(B. Atık Sıvı Seviye Flatörü 40°)

KOD	AÇIKLAMA	AD. / ʘ	K. / AD.
ELEM-FTE 300B	3 m. Flatör	99,00	25
ELEM-FTE 500B	5 m. Flatör	110,00	20
ELEM-FTE 1000B	10 m. Flatör	155,00	15
ELEM-FTE 1500B	15 m. Flatör	190,00	15
ELEM-FTE 2000B	20 m. Flatör	215,00	10

SU SEVİYE ŞALTERLERİ (250 V, AC, SWITCHLİ)



KOD	CİNSİ	AD. / ʘ	K. / AD.
EMFA - 653011	1.5 mt	ʘ	25
EMFA - 653021	2 mt		25
EMFA - 653031	3 mt		25
EMFA - 653041	4 mt		20
EMFA - 653051	5 mt		20
EMFA - 653101	10 mt		1
EMFA - 653151	15 mt		1
EMFA - 653201	20 mt		1

KONTAKLI SU SEVİYE ŞALTERLERİ (250 V, AC)



KOD	CİNSİ	AD. / ʘ	K. / AD.
EMFA - 653501	Kontaktlı 6A 380 V.	ʘ	20

SIVI SEVİYE ELEKTROTU



KOD	CİNSİ	AD. / ʘ
ELEM-ELT- E	Kuyu Tipi Elektrot	ʘ

MOTOR AKSESUARLARI

Gamak Tipi Orjinal Motor Klemensi

KOD	BOY	BOY (mm)	EN (mm)	VİDA	RENK	AD. / ԥ	K. / AD.
OR - MK 01	56 - 63	40	25	M4	Siyah	☎	50
OR - MK 02	71 - 80 - 90 - 100	50	30	M4	Siyah		50
OR - MK 03	132	60	37	M5	Siyah		50
OR - MK 04	160 - 180	72	44	M6	Siyah		40
OR - MK 05	225 - 250	91	56	M8	Siyah		16
OR - MK 06	280	115	70	M10	Siyah		8



Gamak Tipi Orjinal Cam Elyaflı Motor Klemensi







KOD	BOY	BOY (mm)	EN (mm)	VİDA	RENK	AD. / ԥ	K. / AD.
OR - MKE 01	56 - 63	40	25	M4	Kahverengi	☎	50
OR - MKE 02	71 - 80 - 90 - 100	50	30	M4	Kahverengi		50
OR - MKE 03	132	60	37	M5	Kahverengi		50
OR - MKE 04	160 - 180	72	44	M6	Kahverengi		40
OR - MKE 05	225 - 250	91	56	M8	Kahverengi		16
OR - MKE 06	280	115	70	M10	Kahverengi		8



1x16A MONOFAZE KAUÇUK FİŞ PRİZ SERİSİ

ÜRÜN RESMİ	KOD	TEKNİK ÖZELLİKLER	FİYAT / ₺	K./ AD.
	CSM - M101	1 x 16 Kauçuk Düz Fiş	7,20	36
	CSM - M102	1 x 16 Kauçuk Eğik Fiş	7,75	36
	CSM - M103	1 x 16 Kauçuk Seyyar Priz	11,25	20
	CSM - M104	1 x 16 Kauçuk Duvar Prizi	13,95	16
	CSM - M105	1 x 16 Kauçuk İkili Grup Priz	23,10	8
	CSM - M106	1 x 16 Kauçuk Üçlü Grup Priz	32,55	6

1x16A MONOFAZE PLS. PANO ve DUVAR PRİZLERİ

ÜRÜN RESMİ	KOD	TEKNİK ÖZELLİKLER	FİYAT / ₺	K./ AD.
	CSM - M107	1 x 16 PLS. Pano Priz	8,97	30
	CSM - M108	1 x 16 PLS. Pano Priz	???	30
	CSM - M109	1 x 16 PLS. Duvar Priz	14,65	32
	CSM - M110	1 x 16 PLS. Makina Priz	14,10	18
	CSM - M111	1 x 16 PLS. Duvar Priz	18,40	14
	CSM - M112	1 x 16 PLS. Eğik Duvar Priz	26,10	8

3 x 25A POLYAMİD N6 ve KAUÇUK TRİFAZE FİŞ PRİZ

ÜRÜN RESMİ	KOD	TEKNİK ÖZELLİKLER	FİYAT / ₺	K./ AD.
	CSM - T201	3 x 25 Kauçuk Düz Fiş	11,80	24
	CSM - T203	3 x 25 Kauçuk Eğik Fiş	15,50	16
	CSM - T204	3 x 25 Kauçuk Seyyar Priz	17,85	16
	CSM - T205	3x25 Kauçuk Duvar Prizi	26,25	12
	CSM - T206	3x25 PLS. Makina Priz	19,65	18
	CSM - T207	3x25 PLS. Duvar Prizi	21,70	14
	CSM - T208	3x25 PLS. Eğik Duvar Priz	28,95	8
	CSM - T209	3 x 25 1 Adet 1 x 16 1 Adet Grup Priz	43,70	8
	CSM - T210	3 x 25 İkili Grup Priz	44,55	8
	CSM - T211	3 x 25 1 Adet 1 x 16 2 Adet Grup Priz	59,85	6
	CSM - T212	3 x 25 2 Adet 1 x 16 1 Adet Grup Priz	63,25	6
	CSM - T213	3 x 25 3'lü Grup Priz	65,10	6

CE NORM MONOFAZE ve TRİFAZE FİŞ, PRİZ SERİLERİ (IP44)







ÜRÜN RESMİ	KOD	TEKNİK ÖZELLİKLER	FİYAT / ₺	K./ AD.
	CSM - CM250	16/20 3 Kutuplu Pls. Düz Fiş	18,98	20
	CSM - CM251	16/20 3 Kutuplu Pls. Seyyar Priz	22,87	20
	CSM - CM252	16/20 3 Kutuplu Pls. Makina Priz	21,86	24
	CSM - CM253	16/20 3 Kutuplu Pls. Duvar Priz	27,30	18
	CSM - CM254	16/20 3 Kutuplu Pls. Eğik Duvar Priz	31,50	8
	CSM - CT300	4 x 16 Pls. Düz Fiş	19,80	20
	CSM - CT301	4 x 16 Pls. Seyyar Priz	23,10	16
	CSM - CT302	4 x 16 Pls. Makina Priz	22,90	18
	CSM - CT303	4 x 16 Pls. Duvar Priz	32,65	12
	CSM - CT304	4 x 16 Pls. Eğik Duvar Priz	37,60	8
	CSM - CT305	5 x 16 Pls. Düz Fiş	23,80	12
	CSM - CT306	5 x 16 Pls. Seyyar Priz	29,85	10
	CSM - CT307	5 x 16 Pls. Makina Priz	26,35	18
	CSM - CT308	5 x 16 Pls. Duvar Priz	32,80	12
	CSM - CT309	5 x 16 Pls. Eğik Duvar Priz	41,00	8
	CSM - CT310	4 x 32 Pls. Düz Fiş	30,80	12

ÜRÜN RESMİ	KOD	TEKNİK ÖZELLİKLER	FİYAT / ₺	K./ AD.
	CSM - CT311	4 x 32 Pls. Seyyar Priz	34,00	12
	CSM - CT315	5 x 32 Pls. Düz Priz	34,50	12
	CSM - CT316	5 x 32 Pls. Seyyar Priz	38,70	8
	CSM - CT317	5 x 32 Pls. Makina Priz	33,90	12
	CSM - CT318	5 x 32 Pls. Düz Duvar Priz	38,00	10
	CSM - CT319	5 x 32 Pls. Eğik Duvar Priz	45,50	8
	CSM - CT324	5 x 63 Pls. Düz Fiş	183,00	2
	CSM - CT325	5 x 63 Pls. Seyyar Priz	225,00	2
	CSM - CT326	5 x 63 Pls. Makina Priz	200,00	4
	CSM - CT327	5 x 63 Pls. Eğik Duvar Priz	302,00	2





16x25x40 TRİFAZE YASSI FİŞ PRİZ SERİSİ

ÜRÜN RESMİ	KOD	TEKNİK ÖZELLİKLER	FİYAT / ₺	K./ AD.
	CSM - YT400	16 x 25 Yassı Düz Fiş	15,75	16
	CSM - YT401	16 x 25 Yassı Seyyar Priz	23,20	16
	CSM - YT402	16 x 25 Yassı Duvar Priz	23,20	16
	CSM - YT403	24 x 40 Yassı Düz Fiş	35,00	10
	CSM - YT404	24 x 40 Yassı Seyyar Priz	42,50	10
	CSM - YT405	24 x 40 Yassı Duvar Priz	42,50	10







3 x 16A POLYAMİD N6 ve KAUÇUK TRİFAZE FİŞ PRİZ

ÜRÜN RESMİ	KOD	TEKNİK ÖZELLİKLER	FİYAT / ₺	K./ AD.
	CSM - T214	3 x 16 Kauçuk Düz Fiş	18,45	24
	CSM - T215	3 x 16 Kauçuk Eğik Fiş	21,75	16
	CSM - T216	3 x 16 Kauçuk Seyyar Priz	23,00	16
	CSM - T217	3 x 16 Pls. Duvar Priz	25,75	10
	CSM - T218	3 x 16 Pls. Makina Priz	22,10	18
	CSM - T219	3 x 16 Pls. Duvar Priz	26,00	14
	CSM - T220	3 x 16 Pls. Eğik Duvar Priz	38,50	8





SEYYAR KABLO TAŞIYICI PLASTİK MAKARALAR

ÜRÜN RESMİ	KOD	TEKNİK ÖZELLİKLER	FİYAT / ₺	K./ AD.
	CSM - PM420	3 x 1.5 - 25 M. Kapasiteli 4 Prizli Seyyar Taşıyıcı Boş Metal Makara	69,70	1
	CSM - PM421	3 x 1.5 - 50 M. Kapasiteli 4 Prizli Seyyar Taşıyıcı Boş Pls. Makara	79,80	1
	CSM - PM422	3 x 1.5 - 25 M. Kapasiteli Çim Bıçme Makarası Boş Pls. Makara	56,00	1
	CSM - MM432	3 x 1.5 - 50 M. Kapasiteli 4 Prizli Seyyar Taşıyıcı Boş Metal Makara	120,00	1

3 x 32A POLYAMİD N6 ve KAUÇUK TRİFAZE FİŞ PRİZ

ÜRÜN RESMİ	KOD	TEKNİK ÖZELLİKLER	FİYAT / ₺	K./ AD.
	CSM - T221	3 x 32 Kauçuk Düz Fiş	31,85	20
	CSM - T222	3 x 32 Kauçuk Eğik Fiş	33,50	16
	CSM - T223	3 x 32 Kauçuk Seyyar Priz	35,00	12
	CSM - T224	3 x 32 Kauçuk Duvar Priz	43,50	8
	CSM - T225	3 x 32 Pls. Makina Priz	24,80	18
	CSM - T226	3 x 32 Pls. Duvar Priz	29,25	14
	CSM - T227	3 x 32 Pls. Eğik Duvar Priz	49,90	8

BALADOZ ANAHTARLI SEYYAR EL LAMBASI

ÜRÜN RESMİ	KOD	TEKNİK ÖZELLİKLER	FİYAT / ₺	K./ AD.
	CSM - MS118	Anahtarlı Seyyar El Lam.	47,75	6
	CSM - MS119	Anahtarlı 7.5Mt. Kablolu Seyyar El Lambası	71,75	4
	CSM - MS120	Anahtarsız Seyyar El Lam.	42,70	6
	CSM - MS121	Anahtarsız 7.5 Mt. Kablolu Seyyar El Lambası	67,85	4

ST45 SERİSİ LAMBALI İKAZ KULELERİ Ø 45 mm

Qlight



KORNALI İKAZ LAMBALARI - S60AD-B/BF



STANDART ve ENDÜSTRİYEL TİP KORNALAR



SRN



SEHN25

KORNALI İKAZ LAMBALARI - S60ADS



MOTOR SİRENLERİ



SM30



SM40



SM200

KORNALI İKAZ LAMBALARI - S60AD-L/LF



PANEL MONTAJ TİPİ KORNA



SPK

KORNALI İKAZ LAMBALARI - S60ADH-L/F



BUTONLAR ve KORNALAR



FİYAT
SORUNUZ



FLAŞÖRLÜ TEPE LAMBALARI



İKAZ LAMBALARI



ENDÜSTRİYEL TİP İKAZ LAMBALARI



UÇAK İKAZ LAMBALARI



OTO TİPİ ÇAKMAKLI LAMBALAR



ENDÜSTRİYEL KORNALI İKAZ LAMBALARI



İŞIK KOLONLARI



SİRENLER



Çekmece Kilitleri



FIYAT
SORUNUZ

Menteşeler / Kenar Mentешeler

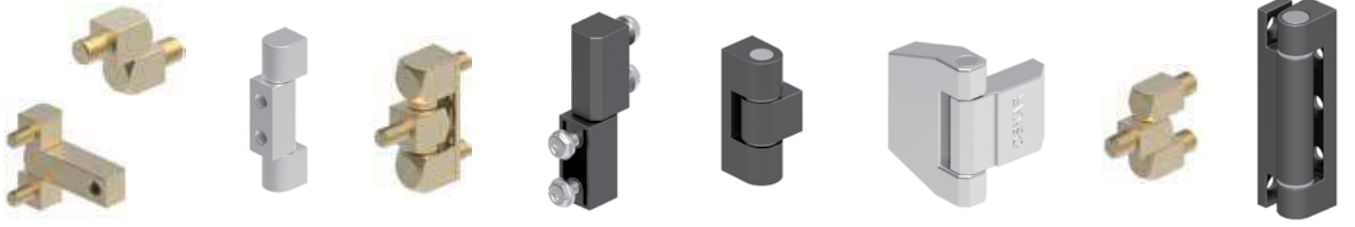

Gizli Mentешeler



Köşe Mentешeler / Yaprak Mentешeler

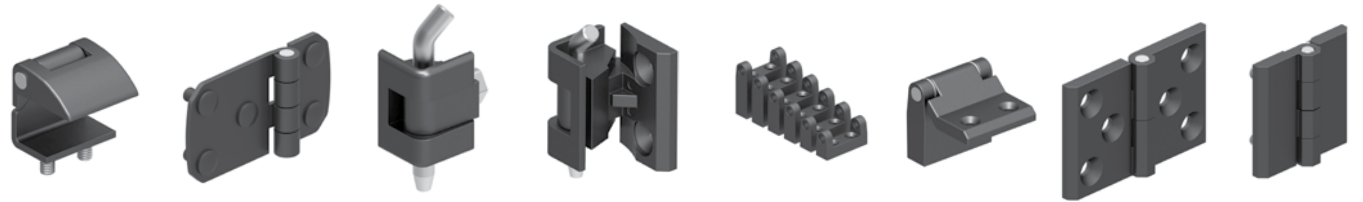

Paslanmaz Çelik Ürünler

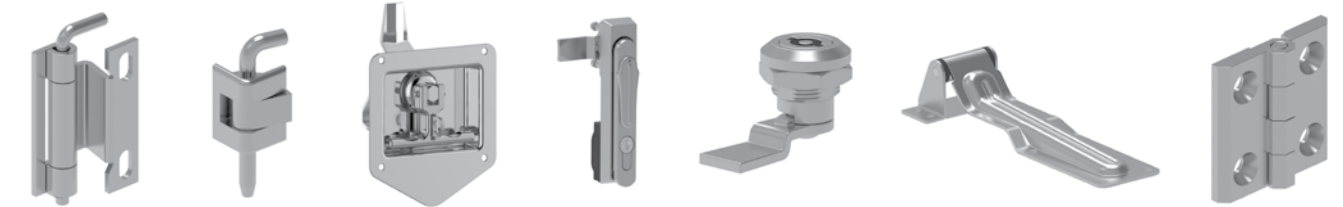

Aksesuarlar

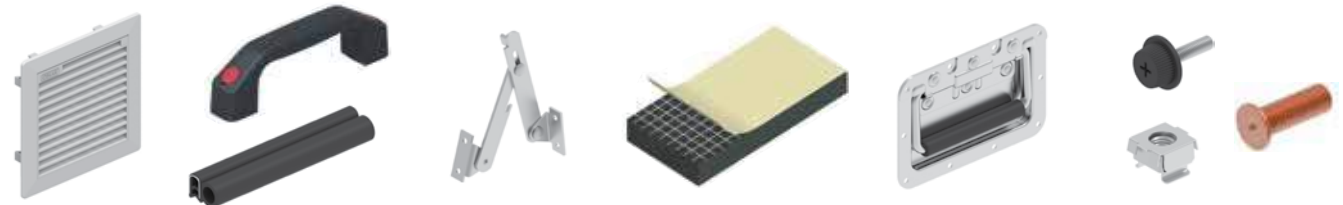

İspanyollet Kollu Pano Kilitleri

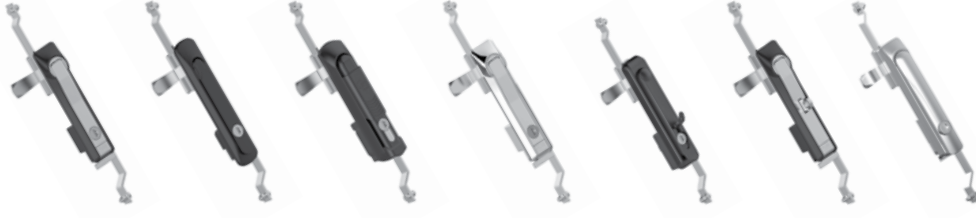

FİYAT
SORUNUZ

Kollu Pano Kilitleri



İspanyollet Çubuk ve Aksesuarları



Kabin Kilitleri



Sıkıştırılmalı Kilitler / Çeşitli Kilitler



Yaylı Pano Kilitleri



AKILLI KONTROL SİSTEMLERİ



**FİYAT
SORUNUZ**



RF UZAKTAN KONTROL ÜNİTELERİ



ELEKTRONİK BALANSLAR



DİMMER GRUPLARI



UNI-T®

Uni-Trend Dijital Elektrik Ölçü Aletleri

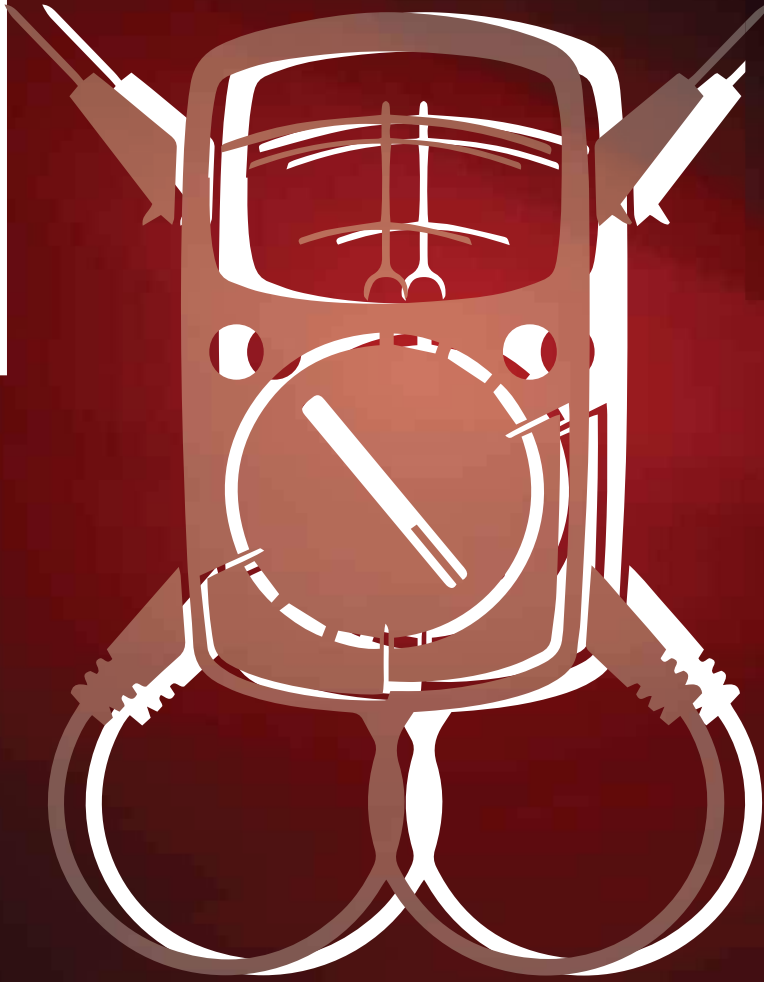



KOD	K. KESİTİ	AD. / ʘ
TAME-E1 4105 - E1 4205	4x1,5 - 4x2,5	45,55
TAME-E1 404 - E1 406	4x4 - 4x6	45,55
TAME-E1 515 - E1 525	5x1,5 - 5x2,5	50,25
TAME-E1 504 - E1 506	5x4 - 5x6	50,25
TAME-E1 715 - E1 725	7x1,5 - 7x2,5	77,70



TAME-E1 410	4 x 10	70,50
TAME-E1 416	4 x 16	72,00
TAME-E1 31610	3 x 16 + 10	71,50
TAME-E1 32516	3 x 25 + 16	75,50
TAME-E1 33516	3 x 35 + 16	79,00
TAME-E1 35025	3 x 50 + 25	82,50
TAME-E1 425	4 x 25	77,00
TAME-E1 435	4 x 35	81,00
TAME-E1 450	4 x 50	84,00
TAME-E1 510-E1 516	5 x 10 - 5 x 16	75,00



KOD	K. KESİTİ	AD. / ʘ
TAME-E1 115 - E1 104	1x1,5 - 1x4	41,50
TAME-E1 106	1x6	41,50
TAME-E1 110	1x10	48,95
TAME-E1 116 - E1 125	1x16 - 1x25	48,95
TAME-E1 135 - E1 150	1x35 - 1x50	52,80
TAME-E1 170 - E1 195	1x70 - 1x95	56,45
TAME-E1 1120 - E1 1150	1x120 - 1x150	75,35
TAME-E1 1185	1x185	94,20
TAME-E1 1240	1x240	97,35
TAME-E1 1300	1x300	126,00
TAME-E1 1400	1x400	132,25
TAME-E1 1500	1x500	142,50

BAKIR İLET. REÇİNELİ KAB. EK MUFLARI (0.6 - 1 kV)



KOD	K. KESİTİ	AD. / ₺
TAME-E1 315 - E1 304	3 x 1,5 - 3 x 4	43,95
TAME-E1 306	3 x 6	43,95
TAME-E1 310	3 x 10	67,85
TAME-E1 316	3 x 16	69,70
TAME-E1 325	3 x 25	71,55
TAME-E1 335	3 x 35	75,35
TAME-E1 350	3 x 50	77,70



TAME-E1 37035	3 x 70 + 35	131,80
TAME-E1 39550	3 x 95 + 50	138,00
TAME-E1 470	4 x 70	135,70
TAME-E1 495	4 x 95	141,15
TAME-E1 525	5 x 25	132,25
TAME-E1 535	5 x 35	134,55
TAME-E1 550	4 x 50	138,00



TAME-E1 215 - E1 204	2 x 1,5 - 2 x 4	42,00
TAME-E1 206	2 x 6	42,00
TAME-E1 210	2 x 10	67,55
TAME-E1 216 - E1 225	2 x 16 - 2 x 25	67,55
TAME-E1 235 - E1 250	2 x 35 - 2 x 50	74,20
TAME-E1 270 - E1 295	2 x 70 - 2 x 95	101,60
TAME-E1 2120 - E1 2150	2 x 120 - 2 x 150	180,50
TAME-E1 2185	2 x 185	188,25
TAME-E1 2240	2 x 240	204,60



TAME-E1 31207	3 x 120 + 70	219,65
TAME-E1 31507	3 x 150 + 70	229,45
TAME-E1 4120	4 x 120	228,90
TAME-E1 4150	4 x 150	238,65
TAME-E1 570	4 x 70	221,00
TAME-E1 595	5 x 95	230,00



KOD	K. KESİTİ	AD. / ₺
TAME-E1 3120	3 x 120	217,35
TAME-E1 3150	3 x 150	226,55

PROTOLİNLER / REÇİNELER



TAME-E1 31859	3 x 185 + 95	338,70
TAME-E1 32401	3 x 240 + 120	369,15
TAME-E1 4185	4 x 185	348,35
TAME-E1 4240	4 x 240	364,00
TAME-E1 5120	5 x 120	340,00
TAME-E1 5150	5 x 150	350,00



KOD	AĞIRLIK (gr)	AD. / ₺
TAME-PRO 210	210	15,00
TAME-PRO 300	300	17,25
TAME-PRO 500	500	24,75
TAME-PRO 600	600	30,50
TAME-PRO 1000	1 000	44,25
TAME-PRO 1500	1 500	66,60
TAME-PRO 2000	2 000	86,25
TAME-PRO 3000	3 000	131,50
TAME-PRO 4000	4 000	154,70
TAME-PRO 20000	20 000	750,00



TAME-E1 3185	3 x 185	336,50
TAME-E1 3240	3 x 240	362,00

YENİLENEBİLİR ESNEK DOLGULU REÇİNELER



TAME-E1 370	3 x 70	130,35
TAME-E1 395	3 x 95	136,40



KOD	AĞIRLIK (gr)	AD. / ₺
TAME-PSİL 1000	1 000	53,00
TAME-PSİL 4000	4 000	173,00
TAME-PSİL 20000	20 000	850,00

AG BUŞING KAPAMALAR



KOD	UYGUN TRAFÖ	AKIM AMPER (A)	AD./ç	K. AD.
TBK - 01	1kV,1000 - 1600kVA (AG)	2000-3150A	100,00	1
TBK - 02	13kV,100 - 1600kVA (OG)	250-3150A	120,00	1
TBK - 04	1kV,200 - 600kVA (AG)	630A	80,00	1
TBK - 05	1kV,500 - 800kVA (AG)	1000-1250A	90,00	1
TBK - 06	1kV,50 - 160kVA (AG)	250A	75,00	1

OG VHD İZOLATÖR KAPAMA



KOD	UYGUN İZOLATÖR	AD./ç	K. AD.
TBK - 03 (Borulu)	36kV, VHD-35 SII	170,00	1
TBKX- 03 (Borusuz)	36kV, VHD-35 SII	130,00	1

OG PARAFUDR KAPAMA

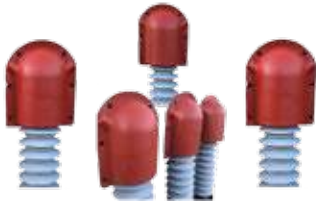

KOD	UYGUN TRAFÖ	AKIM AMPER (A)	(a) DARALMA ÖNCESİ	(a) DARALMA SONRASI	(L) UZUNLUK	AD./ç	K. AD.
TPK-01	36kV, 10-1600kVA	250-3150A	-	-	1,15 veya (25m/rulo)	50,00	1
TAIB 21/7	Q8 İzolasyon Borusu	-	21	7		65,10	Rulo

OG HAVAİ HAT KAPAMA



KOD	İLETKEN TİPİ	MAKSİMUM İLETKEN ÇAPI	AD./ç	METRE
THK - 01	Swallow (3)	16,5 mm	55,00	1
	Raven (1/0)			
	Piegon (3/0)			
	Sparrow (2)			
THK - 02	Hawk 477	37 mm	80,00	1
THK-03	Swallow (3), Raven(1/0), Sparrow (2)		120,00	1
THK-04	Swallow (3), Raven(1/0), Sparrow (2)		40,00	1
THK-05	Piegon (3/0)		45,00	1

BAKIR İLETKENLER İÇİN ISI BÜZÜŞMELİ KABLO EK MUFLARI (0.6 - 1 kV)

BAKIR



KOD	K. KESİTİ	AD. / ₺
TAME-S1 4105	4 x 1,5	21,30
TAME-S1 4205	4 x 2,5	21,30
TAME-S1 404	4 x 4	21,30
TAME-S1 406	4 x 6	21,30
TAME-S1 410	4 x 10	26,55
TAME-S1 416	4 x 16	28,10
TAME-S1 425	4 x 25	43,40
TAME-S1 435	4 x 35	46,70
TAME-S1 450	4 x 50	50,50
TAME-S1 470	4 x 70	70,25
TAME-S1 495	4 x 95	82,25
TAME-S1 4120	4 x 120	107,50
TAME-S1 4150	4 x 150	133,50
TAME-S1 4185	4 x 185	213,55
TAME-S1 4240	4 x 240	223,20
TAME-S1 4300	4 x 300	244,00
TAME-S1 4400	4 x 400	276,00
TAME-S1 31610	3 x 16 + 10	28,10
TAME-S1 32516	3 x 25 + 16	42,00
TAME-S1 33516	3 x 35 + 16	45,55
TAME-S1 35025	3 x 50 + 25	49,10
TAME-S1 37035	3 x 70 + 35	73,55
TAME-S1 39550	3 x 95 + 50	80,30
TAME-S1 31207	3 x 120 + 70	104,85
TAME-S1 31507	3 x 150 + 70	129,30
TAME-S1 31859	3 x 185 + 95	210,85
TAME-S1 32401	3 x 240 + 120	220,60
TAME-S1 33001	3 x 300 + 150	238,45
TAME-S1 34001	3 x 400 + 185	270,55

ALÜMİNYUM



KOD	K. KESİTİ	AD. / ₺
AS1 425	4X25	41,40
AS1 435	4X35	45,55
AS1 450	4X50	49,10
AS1 470	4X70	73,55
AS1 495	4X95	80,50
AS1 4120	4X120	105,95
AS1 4150	4X150	126,50
AS1 4185	4X185	211,95
AS1 4240	4X240	222,50
AS1 4300	4X300	241,20
AS1 4400	4X400	273,00
AS1 32516	3X25+16	40,75
AS1 33516	3X35+16	44,15
AS1 35025	3X50+25	47,90
AS1 37035	3X70+35	72,35
AS1 39550	3X95+50	79,15
AS1 31207	3X120+70	103,40
AS1 31507	3X150+70	122,60
AS1 31859	3X185+95	206,75
AS1 32401	3X240+120	217,35
AS1 33001	3X300+150	236,00
AS1 34001	3X400+185	267,70

FERMUARLI ISI BÜZ. KAB. EK MUF (0.6 - 1 kV)

KOD	K. KESİTİ	AD. / ʘ
TAME-FS1 4105	4 x 1,5	80,50
TAME-FS1 4205	4 x 2,5	80,50
TAME-FS1 404	4 x 4	80,50
TAME-FS1 406	4 x 6	80,50
TAME-FS1 410	4 x 10	86,90
TAME-FS1 416	4 x 16	92,00
TAME-FS1 425	4 x 25	97,75
TAME-FS1 435	4 x 35	99,50
TAME-FS1 450	4 x 50	102,25
TAME-FS1 470	4 x 70	131,00
TAME-FS1 495	4 x 95	135,25
TAME-FS1 4120	4 x 120	161,00
TAME-FS1 4150	4 x 150	166,75
TAME-FS1 4185	4 x 185	199,00
TAME-FS1 4240	4 x 240	218,50
TAME-FS1 4300	4 x 300	264,00
TAME-FS1 4400	4 x 400	293,50
TAME-FS1 31610	3 x 16 + 10	92,00
TAME-FS1 32516	3 x 25 + 16	96,40
TAME-FS1 33516	3 x 35 + 16	97,75
TAME-FS1 35025	3 x 50 + 25	100,65
TAME-FS1 37035	3 x 70 + 35	128,30
TAME-FS1 39550	3 x 95 + 50	132,25
TAME-FS1 31207	3 x 120 + 70	158,20
TAME-FS1 31507	3 x 150 + 70	163,90
TAME-FS1 31859	3 x 185 + 95	195,50
TAME-FS1 32401	3 x 240 + 120	215,80
TAME-FS1 33001	3 x 300 + 150	258,75
TAME-FS1 34001	3 x 400 + 185	287,50



A.G. PAPUÇSUZ REÇ. KAB. BAŞLIKLARI (0.6 - 1 kV)



KOD	K. KESİTİ	AD. / ʘ
TAME-PKB 01	2 x 1,5 - 3 x 50 + 25	18,50
TAME-PKB 02	3 x 120 + 70 - 3 x 150 + 70	26,50
TAME-PKB 03	3 x 70 + 35 - 3 x 95 + 50	46,00



KOD	K. KESİTİ	AD. / ʘ
TAME-B1 504 - B1 506	5 x 4 - 5 x 6	52,80
TAME-B1 510	5 x 10	53,60
TAME-B1 516	5 x 16	55,75
TAME-B1 4105 - B1 4205	4 x 1,5 - 4 x 2,5	44,20
TAME-B1 404 - B1 406	4 x 4 - 4 x 6	44,20
TAME-B1 410	4 x 10	52,10
TAME-B1 416	4 x 16	53,60
TAME-B1 31610	3 x 16 + 10	53,60



TAME-B1 315 - B1 304	3 x 1,5 - 3 x 4	43,65
TAME-B1 306 - B1 310	3 x 6 - 3 x 10	45,95
TAME-B1 316 - B1 325	3 x 16 - 3 x 25	52,40
TAME-B1 335 - B1 350	3 x 35 - 3 x 50	55,95
TAME-B1 370 - B1 395	3 x 70 - 3 x 95	61,60
TAME-B1 3120 - B1 3150	3 x 120 - 3 x 150	100,80
TAME-B1 3185	3 x 185	111,25
TAME-B1 3240	3 x 240	115,00



TAME-B1 32516	3 x 25 + 16	54,00
TAME-B1 33516	3 x 35 + 16	59,50
TAME-B1 35025	3 x 50 + 25	59,50
TAME-B1 37035	3 x 70 + 35	69,00
TAME-B1 39550	3 x 95 + 50	69,00

UÇ KORUYUCULARI



KOD	DARALMA ÖNCESİ (mm)	DARALMA SONRASI (mm)	UZUNLUK (m)	AD. / ʘ
UK 11/5	11	5,5	22	6,90
UK 16/7	16	7,5	75	8,65
UK 25/10	25	10,5	80	9,50
UK 32/16	32	16,5	90	10,85
UK 50/26	50	26	115	13,20
UK 70/37	70	37	120	17,10
UK 100/46	100	46	140	20,10
UK 120/57	120	57	155	23,65

O.G. TEK DAMARLI HARİCİ ISI BÜZÜŞMELİ KABLO BAŞLIKLARI (20.8 - 36 kV)



KOD	K. KESİTİ	AD. / ₺
TAME-IBH36 125	1 x 25 + 16	171,00
TAME-IBH36 135	1 x 35 + 16	171,00
TAME-IBH36 150	1 x 50 + 16	171,00
TAME-IBH36 170	1 x 70 + 16	175,00
TAME-IBH36 195	1 x 95 + 16	175,00
TAME-IBH36 1120	1 x 120 + 16	177,00
TAME-IBH36 1150	1 x 150 + 25	177,00
TAME-IBH36 1185	1 x 185 + 25	179,50
TAME-IBH36 1240	1 x 240 + 25	179,50
TAME-IBH36 1300	1 x 300 + 25	214,00
TAME-IBH36 1400	1 x 400 + 35	236,00
TAME-IBH36 1500	1 x 500 + 35	298,00
TAME-IBH36 1630	1 x 630 + 35	357,00

O.G. TEK DAMARLI DAHİLİ ISI BÜZÜŞMELİ KABLO BAŞLIKLARI (20.8 - 36 kV)



KOD	K. KESİTİ	AD. / ₺
TAME-IBD36 125	1 x 25 + 16	114,00
TAME-IBD36 135	1 x 35 + 16	114,00
TAME-IBD36 150	1 x 50 + 16	114,00
TAME-IBD36 170	1 x 70 + 16	116,00
TAME-IBD36 195	1 x 95 + 16	116,00
TAME-IBD36 1120	1 x 120 + 16	118,50
TAME-IBD36 1150	1 x 150 + 25	118,50
TAME-IBD36 1185	1 x 185 + 25	122,00
TAME-IBD36 1240	1 x 240 + 25	126,50
TAME-IBD36 1300	1 x 300 + 25	171,00
TAME-IBD36 1400	1 x 400 + 35	194,00
TAME-IBD36 1500	1 x 500 + 35	255,50
TAME-IBD36 1630	1 x 630 + 35	309,00

O.G. ÜÇ DAMARLI HARİCİ ISI BÜZÜŞMELİ KABLO BAŞLIKLARI (20.8 - 36 kV)



KOD	K. KESİTİ	AD. / ₺
TAME-IBH36 325	3 x 25 + 16	957,00
TAME-IBH36 335	3 x 35 + 16	957,00
TAME-IBH36 350	3 x 50 + 16	965,00
TAME-IBH36 370	3 x 70 + 16	965,00
TAME-IBH36 395	3 x 95 + 16	972,00
TAME-IBH36 3120	3 x 120 + 16	1.046,00
TAME-IBH36 3150	3 x 150 + 25	1.046,00
TAME-IBH36 3185	3 x 185 + 25	1.046,00
TAME-IBH36 3240	3 x 240 + 25	1.052,00
TAME-IBH36 3300	3 x 300 + 25	1.126,00
TAME-IBH36 3400	3 x 400 + 35	1.149,00
TAME-IBH36 3500	3 x 500 + 35	1.208,00

O.G. ÜÇ DAMARLI DAHİLİ ISI BÜZÜŞMELİ KABLO BAŞLIKLARI (20.8 - 36 kV)



KOD	K. KESİTİ	AD. / ₺
TAME-IBD36 325	3 x 25 + 16	652,00
TAME-IBD36 335	3 x 35 + 16	652,00
TAME-IBD36 350	3 x 50 + 16	660,00
TAME-IBD36 370	3 x 70 + 16	661,50
TAME-IBD36 395	3 x 95 + 16	667,00
TAME-IBD36 3120	3 x 120 + 16	725,50
TAME-IBD36 3150	3 x 150 + 25	725,50
TAME-IBD36 3185	3 x 185 + 25	734,00
TAME-IBD36 3240	3 x 240 + 25	734,00
TAME-IBD 36 3300	3 x 300 + 25	803,00
TAME-IBD 36 3400	3 x 400 + 35	824,50
TAME-IBD 36 3500	3 x 500 + 35	885,00



BARA İZOLASYON BORULARI

KOD	DARALMA ÖNCESİ (mm)	DARALMA SONRASI (mm)	UZUNLUK (m)	AD. / ₺
TAME-TAIB 21/7	21	7	1.2	65,10
TAME-TAIB 33/10	33	10	1.2	74,90
TAME-TAIB 38/12	38	12	1.2	79,00
TAME-TAIB 45/17	45	17	1.2	92,50
TAME-TAIB 54/18	54	18	1.2	95,90
TAME-TAIB 60/22	60	22	1.2	95,90
TAME-TAIB 65/22	65	22	1.2	95,90
TAME-TAIB 75/22	75	22	1.2	95,90
TAME-TAIB 90/30	90	30	1.2	114,50
TAME-TAIB 110/40	110	40	1.2	132,00
TAME-TAIB 125/40	125	40	1.2	132,00
TAME-TAIB 140/40	140	40	1.2	132,00
TAME-TAIB 160/50	160	50	1.2	210,00



REÇİNELİ YALITIM BORULARI

KOD	DARALMA ÖNCESİ (mm)	DARALMA SONRASI (mm)	UZUNLUK (m)	AD. / ₺
TAME-TIB 9/3	9	3	1.2	7,25
TAME-TIB 12/4	12	4	1.2	17,55
TAME-TIB 16/5	16	5	1.2	21,50
TAME-TIB 22/6	22	6	1.2	22,00
TAME-TIB 25/8	25	8	1.2	25,80
TAME-TIB 33/10	33	10	1.2	26,75
TAME-TIB 40/12	40	12	1.2	28,15
TAME-TIB 45/15	45	15	1.2	36,20
TAME-TIB 54/18	54	18	1.2	37,00
TAME-TIB 65/22	65	22	1.2	37,00
TAME-TIB75/22	75	22	1.2	42,75
TAME-TIB 80/30	80	30	1.2	53,85
TAME-TIB 90/30	90	30	1.2	54,90
TAME-TIB 105/33	105	33	1.2	62,40
TAME-TIB 125/40	125	40	1.2	72,80
TAME-TIB 140/40	140	40	1.40	84,10
TAME-TIB 150/50	150	50	1.40	164,50
TAME-TIB 170/58	170	58	1.2	180,00



YENİLENEBİLİR Y BRANŞMAN VİDALI ŞEFFAF KABLO EK MUFLARI

KOD	UYGUN KABLO ÇAPI		d1 (mm)	d2 (mm)	KALAN SARMAL ÇAP		d3 (mm)	L (mm) ANA	KABLO DIŞ ÇAP		UYGUN ÜRÜN NO	AD. / ₺
	ANA	BRANŞMAN			d1 (mm)	d2 (mm)			ANA	BRANŞMAN		
PSİLYE1 31610	3x16+10	3x16+10	22	22	88	-	44	295	22	22	1	270,00
PSİLYE1 32516	3x25+16	3x16+10	25	22	58	-	44	295	25	22	1	218,00
PSİLYE1 33516	3x35+16	3x16+10	27	22	16	84	5	400	27	22	2	308,00
PSİLYE1 35025	3x50+25	3x16+10	31	22	12	21	45	400	31	22	2	308,00
PSİLYE1 37035	3x70+35	3x25+16	35	25	81	84	5	400	35	25	2	310,00
PSİLYE1 39550	3x95+50	3x50+25	40	31	21	29	45	545	40	31	3	485,00
PSİLYE1 31207	3x120+70	3x50+25	45	31	16	29	45	545	45	31	3	488,00
PSİLYE1 31507	3x150+70	3x70+35	48	35	13	18	45	545	48	35	4	642,00
PSİLYE1 31859	3x185+95	3x70+35	53	35	81	64	5	545	53	35	4	642,00
PSİLYE1 32401	3x240+120	3x70+35	60	35	11	64	5	545	60	35	4	642,00

YENİLENEBİLİR DÜZ TİP VİDALI ŞEFFAF KABLO EK MUFLARI

KOD	UYGUN KABLO ÇAPI	d1 (mm)	KALAN SARMAL ÇAP	d2 (mm)	L (mm) ANA	KABLO DIŞ ÇAP	UYGUN ÜRÜN NO	AD. / ₺
	ANA		d1 (mm)			ANA		
PSİLDE1 31610	3x16+10	31	94	5	310	22	1	142,00
PSİLYE1 32516	3x25+16	31	64	5	310	25	1	156,00
PSİLYE1 33516	3x35+16	43	18	45	404	27	2	227,00
PSİLYE1 35025	3x50+25	43	16	45	404	31	2	227,00
PSİLYE1 37035	3x70+35	43	12	45	404	35	2	227,00
PSİLYE1 39550	3x95+50	40	14	45	540	40	3	279,00
PSİLYE1 31207	3x120+70	45	94	5	540	45	3	294,00
PSİLYE1 31507	3x150+70	48	64	5	540	48	3	349,00
PSİLYE1 31859	3x185+95	53	34	5	540	53	3	392,00
PSİLYE1 32401	3x240+120	60	0,2	45	540	60	3	416,00

VİDALI ŞEFFAF T TİPİ REÇİNELİ KABLO EF MUFLARI

KOD	UYGUN KABLO ÇAPI	AD. / ₺
PSİLTE1 4120	4x120	645,00
PSİLTE1 4150	4x150	645,00
PSİLTE1 4185	4x185	645,00
PSİLTE1 42240	4x240	645,00

KOD	UYGUN KABLO ÇAPI		d1 (mm)	d2 (mm)	KALAN SARMAL ÇAP		d3 (mm)	L (mm) ANA	KABLO DIŞ ÇAP		AD. / ₺
	ANA	BRANŞMAN			d1 (mm)	d2 (mm)			ANA	BRANŞMAN	
PSİLTE1 31207	3x120+70	3x95+50	45	40	10	15	65	540	45	40	642,00
PSİLTE1 31507	3x150+70	3x70+35	48	35	72	06	5	540	48	35	642,00
PSİLTE1 31859	3x185+95	3x70+35	53	35	22	06	5	540	53	35	642,00
PSİLTE1 32401	3x240+120	3x70+35	59	35	02	06	5	540	59	35	642,00

 <p>PERFECTS</p> <p>YAĞSIZ KONTAK SPREY 200 ml</p>	 <p>PERFECTS</p> <p>YAĞLI KONTAK SPREY 200 ml</p>	 <p>PERFECTS</p> <p>KÖPÜK TEMİZLEYİCİ SPREY 200 ml</p>
 <p>PERFECTS</p> <p>TABLET TEMİZLEYİCİ SPREY 200 ml</p> <p>LCD EKРАН TEMİZLEYİCİ SPREY 200 ml</p>	 <p>HAWCON</p> <p>YAĞSIZ KONTAK SPREY 200 ml</p>	 <p>HAWCON</p> <p>YAĞLI KONTAK SPREY 200 ml</p>
 <p>WD-40</p> <p>PAS SÖKÜCÜ SPREY 200 / 400 ml</p>	 <p>BETA</p> <p>PLASTİK KONTAK SPREY 200 ml</p>	 <p>BETA</p> <p>PAS SÖKÜCÜ KONTAK SPREY 200 ml</p>
 <p>BETA</p> <p>F50 SOĞUTUCU SPREY</p>	 <p>BETA</p> <p>DUMAN DEDEKTÖRÜ TEST SPREY 400 ml</p>	 <p>WINKEL</p> <p>ANTİSTATİK SPREY 400 ml</p>
 <p>WINKEL</p> <p>SOĞUTUCU SPREY 200 ml</p>	 <p>WINKEL</p> <p>ÇOK AMAÇLI PAS SÖKÜCÜ SPREY 400 ml</p> <p>KUVVETLİ PAS SÖKÜCÜ SPREY 400 ml</p>	 <p>WINKEL</p> <p>ŞEFFAF VERNİK SPREY 400 ml</p> <p>ŞEFFAF VERNİK KIRMIZI SPREY 400 ml</p>

WEICON



Yapıştırıcılar / Sızdırmazlık Malzemeleri



Teknik Spreyler



Teknik Spreyler



Yağlar



FİYAT SORUNUZ



PİLLER

MAX TECH YÜKSEK PERFORMANS ALKALİ SERİSİ



BASICLINE (ŞARJ EDİLEBİLİR PİL)



HIGH ENERGY GÜÇLÜ ALKALİ SERİSİ



LONGIFE ACCU (ŞARJ EDİLEBİLİR PİL)



LONGIFE EXTRA EKONOMİK ALKALİN SERİ



POWER ACCU (ŞARJ EDİLEBİLİR PİL)



ENERGY SERİSİ



EASY ENERGY MINI



SUPERLIFE ÇİNKO KARBON SERİ



EASY ENERGY POCKET



PROFESSIONAL



ELECTRONICS - LITHIUM



POWER



YAYLI PİLLER



PROFESSIONAL LITHIUM



İŞİTME CİHAZI PİLLERİ



ELECTRONICS - ALKALINE



ÖZEL FENERLER



MONOFAZE SERVO REGÜLATÖRLER



KOD	150 - 250 V AD. / 7	130 - 230 V AD. / 7	AŞIRI GERİLİM AD. / 7
SRVL 1 KVA	☎	☎	☎
SRVL 2 KVA			
SRVL 3.5 KVA			
SRVL 5 KVA			
SRVL 7.5 KVA			
SRVL 10 KVA			
SRVL 15 KVA			
SRVL 20 KVA			
SRVL 25 KVA			
SRVL 30 KVA			

TRİFAZE SERVO REGÜLATÖRLER



KOD	275 - 435 V AD. / 7	220 - 400 V AD. / 7	AŞIRI GERİLİM AD. / 7
SRVL 3 KVA	☎	☎	☎
SRVL 7.5 KVA			
SRVL 10.5 KVA			
SRVL 15 KVA			
SRVL 22.5 KVA			
SRVL 30 KVA			
SRVL 45 KVA			
SRVL 60 KVA			
SRVL 75 KVA			
SRVL 100 KVA			
SRVL 120 KVA			
SRVL 150 KVA			

MONOFAZE KESİNTİSİZ GÜÇ KAYNAKLARI



KOD	SÜRE	AD. / \$
SRVL 600 VA L.İA	5 dakika	☎
SRVL 1000 VA L.İA	5 dakika	
SRVL 2000 VA L. İA	5 dakika	
SRVL 1 KVA ONLİNE	7 / 15 dakika	
SRVL 2 KVA ONLİNE	10 / 15 dakika	
SRVL 3 KVA ONLİNE	10 / 15 dakika	
SRVL 6 KVA ONLİNE	10 / 15 dakika	
SRVL 10 KVA ONLİNE	10 / 15 dakika	

TRİFAZE GİRİŞ MONOFAZE ÇIKIŞ



KOD	SÜRE	AD. / \$
SRVL 10 KVA ONLİNE	10 / 15 dakika	☎
SRVL 15 KVA ONLİNE	10 / 15 dakika	
SRVL 20 KVA ONLİNE	10 / 15 dakika	
KOD	SÜRE	AD. / \$
SRVL KOMBİ UPS	180 dakika	☎
SRVL KOMBİ REG		

ŞAFAKSAN

ranel®

EL ALETLERİ BÖLÜMÜ



MEKANİK KABLO MAKASLARI

ŞAFKASAN ranel®

Kablo makası seçiminde makasların kesebileceği kabloların kesimini dikkate alarak değerlendiriniz.



KM-10

KOD	MAX. KESEBİLECEĞİ KABLO	AĞIRLIK	BOY	KESME ÇAPI	AD. / ₺
ŞAFA - KM - 10	1 x 25 mm ² NYAF	0,140 kg	165 mm	Ø10 mm	76,00
Bakır ve Alüminyum Kablolar İçin					



KM-22

KOD	MAX. KESEBİLECEĞİ KABLO	AĞIRLIK	BOY	KESME ÇAPI	AD. / ₺
ŞAFA - KM - 22	4 x 16 mm ² NYY, 1 x 150mm ² NYA	0,690 kg	360 mm	Ø22 mm	152,00
Bakır ve Alüminyum Kablolar İçin					



KM-35

KOD	MAX. KESEBİLECEĞİ KABLO	AĞIRLIK	BOY	KESME ÇAPI	AD. / ₺
ŞAFA - KM - 35	3 x 35 + 10 mm ² NYY, 1 x 185 mm ² 1NYA	1,750 kg	565 mm	Ø35 mm	235,00
Bakır ve Alüminyum Kablolar İçin					



KM-55

KOD	MAX. KESEBİLECEĞİ KABLO	AĞIRLIK	BOY	KESME ÇAPI	AD. / ₺
ŞAFA - KM - 55	3 x 120+70 mm ² NYY, 1 x 500 mm ² NYA	3,400 kg	700 mm	Ø55 mm	505,00
Bakır ve Alüminyum Kablolar İçin					

ACSR VE ÇELİK HALAT MAKASI



CM-10

KOD	MAX. KESEBİLECEĞİ KABLO	AĞIRLIK	BOY	KESME ÇAPI	AD. / ₺
ŞAFA - CM - 10	Pigeon 3/0 10 mm ² Çelik Halat	1,850 kg	510 mm	Ø10 mm	374,00
Çelik Halat ve ACSR Kablolar İçin					

HİDROLİK ÇİFT EL KABLO MAKASLARI



KOD	MAX. KESEBİLECEĞİ KABLO	AĞIRLIK	BOY	KESME KUV.	AD. / ₺
ŞAFA - HCM - 25	25 mm	6,80 kg	660 mm	80 kN	3.309,00
ACSR, çelik halat ve bakır ile alüminyum kablolar içindir. Branda taşıma çantası dahildir. Çalışma Sıcaklığı: -20+ 40 °C.					



KOD	MAX. KESEBİLECEĞİ KABLO	AĞIRLIK	BOY	KESME ÇAPI	AD. / ₺
ŞAFA - HKM - 65	4 x 240 mm ² NYY Bakır ve Alüminyum Kablolar İçin.	7,800 kg	690 mm	Ø65 mm	3.832,00
Kesme Kuvveti: 80 kN Çalışma Sıcaklığı: -20 /+40 °C Branda taşıma çantası dahildir.					



KOD	MAX. KESEBİLECEĞİ KABLO	AĞIRLIK	BOY	KESME ÇAPI	AD. / ₺
ŞAFA - HKM - 85	4 x 400 mm ² NYY Bakır ve Alüminyum Kablolar İçin.	9,100 kg	760 mm	Ø85 mm	4.255,00
Kesme Kuvveti: 80 kN Çalışma Sıcaklığı: -20 /+40 °C Branda taşıma çantası dahildir.					



HİDROLİK HORTUMLU KABLO MAKASLARI

ŞAFAKSAN ranel®



KOD	MAX. KESEBİLECEĞİ KABLO	AĞIRLIK	BOY	KESME ÇAPI	AD. / ₺
ŞAFA - HCM-40 E	40 mm	19,00 kg	2,960 mm	Ø40 mm	4.571,00
Maksimum 25 mm Çelik Halat Keser. Metal Taşıma Çantası Dahildir. Çalışma Sıcaklığı: -20 /+40 °C Kesme Kuvveti: 110 kN					

KOD	MAX. KESEBİLECEĞİ KABLO	AĞIRLIK	BOY	KESME ÇAPI	AD. / ₺
ŞAFA - HKM-65 E	4 x 240 mm ² NYY Metal Taşıma Çantası Dahildir.	20,00 kg	3,020 mm	Ø65 mm	5.004,00
Kesme Kuvveti: 110 kN Çalışma Sıcaklığı: -20 /+40 °C					

KOD	MAX. KESEBİLECEĞİ KABLO	AĞIRLIK	BOY	KESME ÇAPI	AD. / ₺
ŞAFA - HKM-85 E	4 x 400 mm ² NYY Metal Taşıma Çantası Dahildir.	21,20 kg	3,075 mm	Ø85 mm	5.300,00
Kesme Kuvveti: 110 kN Çalışma Sıcaklığı: -20 /+40 °C					

KOD	MAX. KESEBİLECEĞİ KABLO	AĞIRLIK	BOY	KESME ÇAPI	AD. / ₺
ŞAFA - HCB - 40	40 mm	4,075 kg	385 mm	Ø40 mm	2.047,00
Maksimum 25 mm Çelik Halat keser. Branda Taşıma Çantası Dahildir.					

KOD	MAX. KESEBİLECEĞİ KABLO	AĞIRLIK	BOY	KESME ÇAPI	AD. / ₺
ŞAFA - HMB - 65	4 x 240 mm ² NYY	5,850 kg	415 mm	Ø65 mm	2.400,00
Branda taşıma çantası dahildir.					

KOD	MAX. KESEBİLECEĞİ KABLO	AĞIRLIK	BOY	KESME ÇAPI	AD. / ₺
ŞAFA - HMB - 85	4 x 400 mm ² NYY	7,060 kg	470 mm	Ø85 mm	2.582,00
Branda taşıma çantası dahildir.					

MEKANİK PABUÇ SIKMA PENSELERİ



KOD	SIKMA KAPASİTESİ	AĞIRLIK	BOY	AD. / ₺
ŞAFA - KSP - 50	6 - 50 mm ²	1,250 kg	375 mm	256,00
Standart tip bakır kablo pabuçlarını sıkır.				

KOD	SIKMA KAPASİTESİ	AĞIRLIK	BOY	AD. / ₺
ŞAFA - CSP - 25	16 - 25 mm ²	3,680 kg	610 mm	567,00
Çelik halat yüksüklerini sıkır. (Mermer ocakları için tavsiye edilir)				

KOD	SIKMA KAPASİTESİ	AĞIRLIK	BOY	AD. / ₺
ŞAFA - KSP - 85	10 - 120 mm ²	3,530 kg	610 mm	380,00
Standart tip bakır kablo pabuçlarını sıkır.				



KOD	SIKMA KAPASİTESİ	AĞIRLIK	BOY	AD. / ʈ
ŞAFA - KSP - 150	16 - 150 mm ²	3,420 kg	650 mm	391,00
Standart tip bakır kablo pabuçlarını sıkır.				

MEKANİK PABUÇ SIKMA PENSELERİ



KOD	SIKMA KAPASİTESİ	AĞIRLIK	BOY	AD. / ʈ
ŞAFA - KSP - 240	120 - 240 mm ² Standart tip bakır kablo pabuçlarını sıkır.	4,450 kg	950 mm	978,00
Branda taşıma çantası dahildir.				



KOD	SIKMA KAPASİTESİ	AĞIRLIK	BOY	AD. / ʈ
ŞAFA - KSP 10 / 240	120 - 240 mm ² Siparişte aksi belirtilmedikçe MW CU kalıplar ile sevk edilir.	9,600 kg	800 mm	1.121,00
Branda taşıma çantası dahildir.				



KOD	SIKMA KAPASİTESİ	AĞIRLIK	BOY	AD. / ʈ
ŞAFA - KSP 10 / 300	120 - 300 mm ² Siparişte aksi belirtilmedikçe MW CU kalıplar ile sevk edilir.	9,700 kg	800 mm	1.415,00
Branda taşıma çantası dahildir.				

HİDROLİK SIKMA BAŞLIĞI (SIKMA KALIPLARI BAŞLIK FİYATLARINA DAHİL DEĞİLDİR).



KOD	SIKMA KAPASİTESİ	AĞIRLIK	BOY	AD. / ʈ
ŞAFA - HSB - 300 U	10 - 300 mm ² 700 bar pompalar ve MW CU ve AG CU tipli kalıplar ile kullanılabilir.	2,600 kg	250 mm	1.110,00
Branda taşıma çantası dahildir.				



KOD	SIKMA KAPASİTESİ	AĞIRLIK	BOY	AD. / ʈ
ŞAFA - HSB - 300 CM	10 - 300 mm ² 700 bar pompalar ve MW CU ve AG CU tipli kalıplar ile kullanılabilir.	7,900 kg	290 mm	1.455,00
Branda taşıma çantası dahildir.				



KOD	SIKMA KAPASİTESİ	AĞIRLIK	BOY	AD. / ʈ
ŞAFA - HSB - 400 U	10 - 400 mm ² 700 bar pompalar ve DIN CU, DIN AL ve BM tipli kalıplar ile kullanılabilir.	3,300 kg	270 mm	1.291,00
Branda taşıma çantası dahildir.				



KOD	SIKMA KAPASİTESİ	AĞIRLIK	BOY	AD. / ʈ
ŞAFA - HSB - 625 U	150 - 625 mm ² 700 bar pompalar ve DIN CU, DIN AL ve BM tipli kalıplar ile kullanılabilir.	16,00 kg	227 mm	4.566,00
Branda taşıma çantası dahildir.				

HİDROLİK ÇİFT EL SIKMA PENSELERİ

ŞAFKSAK RANEL®



KOD	SIKMA KAPASİTESİ	STROK BOYU	AĞIRLIK	BOY	AD. / ₺
ŞAFA - HSP - 240	10 - 240 mm ²	22 mm	4,600 kg	500 mm	2.269,00

Sıkma Kuvveti: 65 kN **Çalışma Sıcaklığı:** -20 /+40 °C / 360° döner sıkma başlığı basınç ayar sınırlayıcılar ve işlem sonu klik sesi verir. Standart tip bakır kablo pabuçlarını sikar. Branda taşıma çantası dahildir.



KOD	SIKMA KAPASİTESİ	STROK BOYU	AĞIRLIK	BOY	AD. / ₺
ŞAFA - HSP - 300	10 - 300 mm ²	22 mm	4,800 kg	540 mm	2.858,00

Sıkma Kuvveti: 75 kN **Çalışma Sıcaklığı:** -20 /+40 °C / 360° döner sıkma başlığı basınç ayar sınırlayıcılar ve işlem sonu klik sesi verir. Standart tip bakır kablo pabuçlarını sikar. Branda taşıma çantası dahildir.



KOD	SIKMA KAPASİTESİ	STROK BOYU	AĞIRLIK	BOY	AD. / ₺
ŞAFA - HSP - 400	10 - 400 mm ²	26 mm	5,800 kg	580 mm	4.521,00

Sıkma Kuvveti: 135 kN **Çalışma Sıcaklığı:** -20 /+40 °C / 360° döner sıkma başlığı basınç ayar sınırlayıcılar ve işlem sonu klik sesi verir. Branda taşıma çantası dahildir.

NOT: Siparişte aksi belirtilmedikçe MW CU kalıplar takılarak sevk edilir.

HİDROLİK HORTUMLU SIKMA PENSELERİ



KOD	SIKMA KAPASİTESİ	SIKMA KUVVETİ	AĞIRLIK	BOY	AD. / ₺
ŞAFA - HSP - 10/300	10 - 300 mm ² Çalışma Basıncı 700 Bar	75 kN	15,300 kg	2,800 mm	4.180,00

Çalışma Sıcaklığı: -20 /+40 °C / Standart tip bakır kablo pabuçlarını sikar. Sıkma kalıpları 180 cm hortum, sıkma başlığı ve metal taşıma çantası dahildir.



KOD	SIKMA KAPASİTESİ	SIKMA KUVVETİ	AĞIRLIK	BOY	AD. / ₺
ŞAFA - HSP - 10/300 A	10 - 300 mm ² Çalışma Basıncı 700 Bar	75 kN	15,600 kg	2,750 mm	4.727,00

Çalışma Sıcaklığı: -20 /+40 °C / Standart tip bakır kablo pabuçlarını sikar. Sıkma kalıpları 180 cm hortum, sıkma başlığı ve metal taşıma çantası dahildir.



KOD	SIKMA KAPASİTESİ	SIKMA KUVVETİ	AĞIRLIK	BOY	AD. / ₺
ŞAFA - HSP - 10/300 CMA	10 - 300 mm ² Çalışma Basıncı 700 Bar	75 kN	20,500 kg	2,840 mm	4.962,00

Çalışma Sıcaklığı: -20 /+40 °C / Standart tip bakır kablo pabuçlarını sikar. Sıkma kalıpları 180 cm hortum, sıkma başlığı ve metal taşıma çantası dahildir.

HİDROLİK HORTUMLU SIKMA PENSELERİ

ŞAFKASAN ranel®



KOD	SIKMA KAPASİTESİ	SIKMA KUVVETİ	AĞIRLIK	BOY	AD. / ʘ
ŞAFA - HSP - 10/400	10 - 400 mm ² Çalışma Basıncı 700 Bar	135 kN	19,00 kg	2,870 mm	5.466,00

Çalışma Sıcaklığı: -20 / +40 °C / Standart tip bakır kablo pabuçlarını sıkır. Sıkma kalıpları 180 cm hortum, sıkma başlığı ve metal taşıma çantası dahildir.



KOD	SIKMA KAPASİTESİ	SIKMA KUVVETİ	AĞIRLIK	BOY	AD. / ʘ
ŞAFA - HSP - 10/400 A	10 - 400 mm ² Çalışma Basıncı 700 Bar	135 kN	17,40 kg	2,780 mm	5.992,00

Çalışma Sıcaklığı: -20 / +40 °C / Basınç ayar sınırlayıcıdır. Metal taşıma çantası dahildir.



KOD	SIKMA KAPASİTESİ	SIKMA KUVVETİ	AĞIRLIK	BOY	AD. / ʘ
ŞAFA - HSP - 150/625	150 - 625 mm ² Çalışma Basıncı 700 Bar	325 kN	22,70 kg	2,780 mm	8.571,00

Çalışma Sıcaklığı: -20 / +40 °C / Basınç ayar sınırlayıcıdır. Metal taşıma çantası dahildir.

MW / ALTİGEN SIKMA KALIPLARI



KOD	SIKILACAK BAKIR PABUÇ ve EK MUF	AD. / ʘ
ŞAFA - MW CU 10/120	SKP Standart ve Normal 10 - 120 mm ²	90,00
ŞAFA - MW CU 16/70	SKP Standart ve Normal 16 - 70 mm ²	90,00
ŞAFA - MW CU 25/95	SKP Standart ve Normal 25 - 95 mm ²	90,00
ŞAFA - MW CU 35/50	SKP Standart ve Normal 35 - 50 mm ²	90,00
ŞAFA - MW CU 150	SKP Standart ve Normal 150 mm ²	90,00
ŞAFA - MW CU 185	SKP Standart ve Normal 185 mm ²	90,00
ŞAFA - MW CU 240	SKP Standart ve Normal 240 mm ²	90,00
ŞAFA - MW CU 300	SKP Standart ve Normal 300 mm ²	90,00

Bu tablodaki kalıplar, KSP-10/240, KSP-10/300, HSP-240, HSP-300, HSP-10/240, HSP-10/300, HSP-10/300 A, HSP-10/300 CMA sıkma penselerinde kullanılır.

Sıkma Formu: MW/Altigen Sıkma Genişliği: 5 mm Sıkma Kesiti: 16-300 mm² Sıkma Kuvveti: 65 kN



KOD	SIKILACAK BAKIR PABUÇ ve EK MUF	AD. / ʘ
ŞAFA - AG CU 10/120	SKP Standart ve Normal 10 - 120 mm ²	90,00
ŞAFA - AG CU 16/70	SKP Standart ve Normal 16 - 70 mm ²	90,00
ŞAFA - AG CU 25/95	SKP Standart ve Normal 25 - 95 mm ²	90,00
ŞAFA - AG CU 35/50	SKP Standart ve Normal 35 - 50 mm ²	90,00
ŞAFA - AG CU 150	SKP Standart ve Normal 150 mm ²	90,00
ŞAFA - AG CU 185	SKP Standart ve Normal 185 mm ²	90,00
ŞAFA - AG CU 240	SKP Standart ve Normal 240 mm ²	90,00
ŞAFA - AG CU 300	SKP Standart ve Normal 300 mm ²	90,00

Bu tablodaki kalıplar, KSP-10/240, KSP-10/300, HSP-240, HSP-300, HSP-10/240, HSP-10/300, HSP-10/300 A, HSP-10/300 CMA sıkma penselerinde kullanılır.

Sıkma Formu: Altigen Sıkma Genişliği: 5 mm Sıkma Kesiti: 10-300 mm² Sıkma Kuvveti: 65 kN

DIN 46235 SKP BAKIR PABUÇ & DIN 46237-2 EK MUF

ŞAFKASAN ranel®



KOD	SIKILACAK BAKIR PABUÇ ve EK MUF	AD. / ʈ
ŞAFA - DIN CU 10/120	DIN 46235 SKP ve DIN 46237 EK MUF 10 - 120 mm ²	101,00
ŞAFA - DIN CU 16/70	DIN 46235 SKP ve DIN 46237 EK MUF 16 - 70 mm ²	101,00
ŞAFA - DIN CU 25/95	DIN 46235 SKP ve DIN 46237 EK MUF 25 - 95 mm ²	101,00
ŞAFA - DIN CU 35/50	DIN 46235 SKP ve DIN 46237 EK MUF 35 - 50 mm ²	101,00
ŞAFA - DIN CU 150	DIN 46235 SKP ve DIN 46237 EK MUF 150 mm ²	101,00
ŞAFA - DIN CU 185	DIN 46235 SKP ve DIN 46237 EK MUF 185 mm ²	101,00
ŞAFA - DIN CU 240	DIN 46235 SKP ve DIN 46237 EK MUF 240 mm ²	101,00
ŞAFA - DIN CU 300	DIN 46237 SKP ve DIN 46237 EK MUF 300 mm ²	101,00
ŞAFA - DIN CU 400	DIN 46237 SKP ve DIN 46237 EK MUF 400 mm ²	101,00

Bu tablodaki kalıplar, HSB-400 U, HSP-400 ve HSP-10/400, HSP-10/400A sıkma penselerinde kullanılır.

Sıkma Formu: Altıgen Sıkma Genişliği: 10 mm Sıkma Kesiti: 16-400 mm² Sıkma Kuvveti: 135 kN



KOD	SIKILACAK BAKIR PABUÇ ve EK MUF	AD. / ʈ
ŞAFA - DIN AL 16/70	DIN Norm Alüminyum 16 - 70 mm ²	101,00
ŞAFA - DIN AL 25/95	DIN Norm Alüminyum 25 - 95 mm ²	101,00
ŞAFA - DIN AL 35/50	DIN Norm Alüminyum 35 - 50 mm ²	101,00
ŞAFA - DIN AL 120	DIN Norm Alüminyum 120 mm ²	101,00
ŞAFA - DIN AL 150	DIN Norm Alüminyum 150 mm ²	101,00
ŞAFA - DIN AL 185	DIN Norm Alüminyum 185 mm ²	101,00
ŞAFA - DIN AL 240	DIN Norm Alüminyum 240 mm ²	101,00
ŞAFA - DIN AL 300	DIN Norm Alüminyum 300 mm ²	290,00
ŞAFA - DIN AL 400	DIN Norm Alüminyum 400 mm ²	290,00

Bu tablodaki kalıplar, HSB-400 U, HSP-400 ve HSP-10/400, HSP-10/400A sıkma penselerinde kullanılır.

Sıkma Formu: Altıgen Sıkma Genişliği: 10 mm Sıkma Kesiti: 16-400 mm² Sıkma Kuvveti: 135 kN

DIN 46329 ALÜMİNYUM KABLO PABUÇ ve 46267-2 EK MUFLAR İÇİN



KOD	SIKILACAK BAKIR PABUÇ ve EK MUF	AD. / ʈ
ŞAFA - BM 16/25/3	Bimetal (AL-CU) 16-25-35 mm ²	101,00
ŞAFA - BM 50/70/95	Bimetal (AL-CU) 50-70-95 mm ²	101,00
ŞAFA - BM 120	Bimetal (AL-CU) 120 mm ²	101,00
ŞAFA - BM 150	Bimetal (AL-CU) 150 mm ²	101,00
ŞAFA - BM 185	Bimetal (AL-CU) 185 mm ²	101,00
ŞAFA - BM 240	Bimetal (AL-CU) 240 mm ²	101,00
ŞAFA - BM 300/400	Bimetal (AL-CU) 300/400 mm ²	290,00

Bu tablodaki kalıplar, HSB-400 U, HSP-400 ve HSP-10/400, HSP-10/400A sıkma penselerinde kullanılır.

Sıkma Formu: Altıgen Sıkma Genişliği: 10 mm Sıkma Kesiti: 16-400 mm² Sıkma Kuvveti: 135 kN



KOD	SIKMA KESİTİ	SIKILACAK BAKIR PABUÇ ve EK MUF	AD. / ʈ
ŞAFA - KSP-50 K	6 - 50 mm ²	SKP Standart tip ve Normal 6 - 50 mm ² (KSP-50 Sıkma Pensesi kalıbıdır.)	53,00
ŞAFA - KSP-85 K	10 - 120 mm ²	SKP Standart tip ve Normal 6 - 120 mm ² (KSP-85 Sıkma Pensesi kalıbıdır.)	59,00
ŞAFA - KSP-150 K	16 - 150 mm ²	SKP Standart tip ve Normal 6 - 150 mm ² (KSP-150 Sıkma Pensesi kalıbıdır.)	76,00
ŞAFA - CSP-25 K	16 - 25 mm ²	ÇAP 5 - 8 mm çelik halat yüksüğü (CSP-25 Sıkma Pensesi kalıbıdır.)	93,00

Sıkma Formu: Altıgen Sıkma Genişliği: 5 mm

DÖNER KALIP ve PİM TAKIMLARI

ŞAFAKSAN ranel®



KOD	AÇIKLAMA	AĞIRLIK	BOY	AD. / ʈ
ŞAFA - CSP-25 P	CSP-25 için	48 gr	50 mm	52,00
ŞAFA - CSP-85 P	CSP-85 için	48 gr	50 mm	52,00

KOD	AÇIKLAMA	AĞIRLIK	BOY	AD. / ʈ
ŞAFA - KSP-50 P	KSP-50 için	28 gr	35 mm	58,00
ŞAFA - KSP-150 P	KSP-150 için	62 gr	48 mm	69,00

HİDROLİK PUNCH ve KALIP SETLERİ



KOD	AÇIKLAMA	ÇALIŞMA SIC.	AĞIRLIK (kg)	BOY (mm)	AD. / ʈ
ŞAFA - HPP-700	1 adet hidrolik punch pompası 1 adet cıvata 9,5x75 mm 1 adet cıvata 19x136 mm 1 adet adaptör 1 adet bilezik seti (3 parçalı)	-20,+40 °C	3,900	460	1.883,00
KAPASİTE	Delme kapasitesi: Ø106 mm dairesel ve 68 x 68 mm dörtgen. Branda taşıma çantası dahildir.				



KOD	AÇIKLAMA	ÇEK. KUV.	ÇAL. SIC.	AĞ. (kg)	BOY (mm)	STROK BOYU	AD. / ʈ
ŞAFA - HPP-16/48	1 adet hidrolik punch pompası 1 adet hidrolik punch çekirme başlığı 1 adet cıvata 9,5x75 mm 1 adet cıvata 19x136 mm 1 adet adaptör 1 adet bilezik seti (3 parçalı) PD-16 PD-21 PD-29 PD-36 PD-42 PD-48	80 kN	-20,+40 °C	3,200	500	24	3.191,00
KAPASİTE	Delme kapasitesi: Ø106 mm dairesel ve 68 x 68 mm dörtgen						



KOD	AÇIKLAMA	ÇEK. KUV.	ÇAL. SIC.	AĞ. (kg)	BOY (mm)	STROK BOYU	AD. / ʈ
ŞAFA - HPP-9/48	1 adet hidrolik punch pompası 1 adet cıvata 9,5x75 mm 1 adet cıvata 19x136 mm 1 adet adaptör 1 adet bilezik seti (3 parçalı) PD-9 PD-11 PD-13 PD-16 PD-21 PD-29 PD-30 PD-36 PD-42 PD-48	80 kN	-20,+40 °C	3,500	500	24	4.175,00
KAPASİTE	Delme kapasitesi: Ø106 mm dairesel ve 68 x 68 mm dörtgen						

HİDROLİK PUNCH ve KALIP SETLERİ

ŞAFKASAN **ranel®**



KOD	AÇIKLAMA	ÇALIŞMA SIC.	AĞIRLIK (kg)	BOY (mm)	AD. / ʈ
ŞAFA - HPB-140	1 adet hidrolik punch çekirme başlığı 1 adet cıvata 9,5x75 mm 1 adet cıvata 19x136 mm 1 adet adaptör 1 adet bilezik seti (3 parçalı)	-20,+40 °C	3,420	140	1.150,00
KAPASİTE	Delme kapasitesi: Ø106 mm dairesel ve 138 x 138 mm dörtgen. Branda taşıma çantası dahildir.				



KOD	AÇIKLAMA	ÇALIŞMA SIC.	AĞIRLIK (kg)	BOY (mm)	AD. / ʈ
ŞAFA - HPC-E	1 adet hidrolik punch çekirme başlığı 1 adet hidrolik el pompası (600 bar) 1 adet 1/4' hidrolik pompa hortumu 1 adet otomatik rekor 1 adet cıvata 9,5x75 mm 1 adet cıvata 19x136 mm 1 adet adaptör 1 adet bilezik seti (3 parçalı)	-20,+40 °C	15,100	2,700	2.570,00
KAPASİTE	Delme kapasitesi: Ø106 mm dairesel ve 138 x 138 mm dörtgen. Metal taşıma çantası dahildir.				
Çekme Kuvveti: 140 kN					



KOD	AÇIKLAMA	ÇALIŞMA SIC.	AĞIRLIK (kg)	BOY (mm)	AD. / ʈ
ŞAFA - HPC-A	1 adet hidrolik punch çekirme başlığı 1 adet hidrolik el pompası (600 bar) 1 adet 1/4' hidrolik pompa hortumu 1 adet otomatik rekor 1 adet cıvata 9,5x75 mm 1 adet cıvata 19x136 mm 1 adet adaptör 1 adet bilezik seti (3 parçalı)	-20,+40 °C	15,400	2,545	2.772,00
KAPASİTE	Delme kapasitesi: Ø106 mm dairesel ve 92 x 92 mm dörtgen. Metal taşıma çantası dahildir.				
Çekme Kuvveti: 140 kN					

MEKANİK KABLO MAKASLARI



KOD	MAX. KESEBİLECEĞİ KABLO	KESME ÇAPI	AĞIRLIK	CETVEL BOY AYARI	EBATLAR	AD. / ʈ
KM-22 M	4x16 mm NYY 1x150 mm NYA	22 mm	1,30 kg	50 cm	11x38x56	316,00
KM-35 M	3x35+10 mm NYY 1x185 mm NYA	35 mm	2,85 kg	50 cm	16x56x60	4,17,00
KM-55 M	3x120+70 mm NYY 1x500 mm NYA	55 mm	3,60 kg	50 cm	18x56x72	618,00

PUNCH ve KALIP SETLERİ

ŞAFAKSAN ranel®



KOD	AÇIKLAMA	AD. / ʈ
ŞAFA - PDS 9/48	PD-9 / PD-11 / PD-13 / PD-16 / PD-21 / PD-29 / PD-36 / PD-42 / PD-48 / PD-30	2.760,00

Dairesel Punch Setleri hidrolik ve mekanik aletlerle kullanılır.

KOD	AÇIKLAMA	AD. / ʈ
ŞAFA - PDS 9/21	PD-9 / PD-11 / PD-13 / PD-16 / PD-21	1.018,00

Dairesel Punch Setleri hidrolik ve mekanik aletlerle kullanılır.

KOD	AÇIKLAMA	AD. / ʈ
ŞAFA - PDS 16/48	PD-16 / PD-21 / PD-29 / PD-36 / PD-42 / PD-48	2.041,00

Dairesel Punch Setleri hidrolik ve mekanik aletlerle kullanılır.

KOD	AÇIKLAMA	DELİK ÇAPI (mm)	KESME KAP. St 37	PİLOT DELİK ʈ (mm)	AD. / ʈ
ŞAFA - PK 46	Çektirme Somunu, Çektirme Pimi, Punch, Kalıp	46 X 46	2 mm	29	1.243,00
ŞAFA - PK 68	Çektirme Somunu, Çektirme Pimi, Punch, Kalıp	68 x 68	2 mm	29	1.741,00
ŞAFA - PK 92	Çektirme Somunu, Çektirme Pimi, Punch, Kalıp	92 x 92	2 mm	29	2.321,00
ŞAFA - PK 138	Çektirme Somunu, Çektirme Pimi, Punch, Kalıp	138 x 138	2 mm	29	2.836,00

Kare Punch Setleri hidrolik aletlerle kullanılır.

PUNCH ÇEKTİRME, CIVATA ve PİMLERİ



KOD	AÇIKLAMA	PG NUMARASI (Rekor No)	DELİK ÇAPI (mm)	KESME KAP. St 37	PİLOT DELİK ʈ (mm)	AD. / ʈ
ŞAFA - PD-9	Punch+ Kalıp	PG-9	15,2	2 mm	10	145,00
ŞAFA - PD-11	Punch+ Kalıp	PG-11	18,6	2 mm	10	152,00
ŞAFA - PD-13	Punch+ Kalıp	PG-13	20,4	2 mm	10	160,00
ŞAFA - PD-16	Punch+ Kalıp	PG-16	22,5	2 mm	10	167,00
ŞAFA - PD-21	Punch+ Kalıp	PG-21	28,3	2 mm	10	196,00
ŞAFA - PD-29	Punch+ Kalıp	PG-29	37,0	3 mm	20	269,00
ŞAFA - PD-36	Punch+ Kalıp	PG-36	47,0	3 mm	20	357,00
ŞAFA - PD-42	Punch+ Kalıp	PG-42	54,0	3 mm	20	379,00
ŞAFA - PD-48	Punch+ Kalıp	PG-48	60,0	3 mm	20	445,00
ŞAFA - PD-30	Punch+ Kalıp		30,5	2 mm	10	197,00

KOD	PİLOT DELİK ʈ (mm)	AD. / ʈ
ŞAFA - PCV 9,5x50	10	78,00
ŞAFA - PCV 19x75	20	90,00

KOD	AÇIKLAMA	AĞIRLIK	EBATLAR	AD. / ʈ
ŞAFA - PIM-031	Özel Alaşımli Çelik	40 gr	9,5 x 75 mm	85,00

HPB Hidrolik Punch Çektirme Başlığı için uygundur.

KOD	AÇIKLAMA	AĞIRLIK	EBATLAR	AD. / ʈ
ŞAFA - PIM-029	Özel Alaşımli Çelik	265 gr	19 x 136 mm	96,00

HPB Hidrolik Punch Çektirme Başlığı için uygundur.

KOD	AÇIKLAMA	AĞIRLIK	EBATLAR	AD. / ʈ
ŞAFA - PIM-030	Özel Alaşımli Çelik	110 gr	20 x 76 mm	102,00

HİDROLİK EL POMPALARI ve HORTUMLARI

ŞAFKAXAN **ranel®**



KOD	UYGULADIĞI BASINÇ	AĞIRLIK	BOY	AD. / ʈ
ŞAFA - HEP-700	Çalışma Basıncı: 700 Bar	5,800 kg	510 mm	1.610,00

Sıkma, delme, kesme başlıklarımız ile veya tek başına da farklı amaçlar için kullanılabilir. Basınç ayar sınırlayıcıdır. Branda taşıma çantası dahildir.



KOD	UYGULADIĞI BASINÇ	AĞIRLIK	BOY	AD. / ʈ
ŞAFA - HEP-1000	Çalışma Basıncı: 1000 Bar	8,400 kg	520 mm	2.148,00

Sıkma, delme, kesme başlıklarımız ile veya tek başına da farklı amaçlar için kullanılabilir. Basınç ayar sınırlayıcıdır. Branda taşıma çantası dahildir.



KOD	UYGULADIĞI BASINÇ	AĞIRLIK	BOY	AD. / ʈ
ŞAFA - HAP-700	Çalışma Basıncı: 700 Bar	6,100 kg	410 mm	1.898,00

Sıkma, delme, kesme başlıklarımız ile veya tek başına da farklı amaçlar için kullanılabilir. Basınç ayar sınırlayıcıdır. Branda taşıma çantası dahildir.



KOD	ET KALINLIĞI	ÇAPI	UZUNLUK	AD. / ʈ
ŞAFA - HPH-180	4 mm	15 mm	1,8 mt	322,00
ŞAFA - HPH-300	4 mm	15 mm	3 mt	455,00
ŞAFA - HPH-600	4 mm	15 mm	6 mt	822,00
ŞAFA - HPH-1000	4 mm	15 mm	10 mt	1.227,00



HPR-3/8 D



HPR-3/8 E

KOD	MALZEME CİNSİ	ÇAPI	AD. / ʈ
ŞAFA - HPR-3/8 D	Çelik	3/8	139,00
ŞAFA - HPR-3/8 E	Çelik	3/8	139,00

MEKANİK RAY ve BARA MAKASLARI



KOD	AÇIKLAMA	AĞIRLIK	EBATLAR	AD. / ʈ
ŞAFA - MRK-1	1 çeşit ray (35x7,5) keser ve raya Ø 5,5 mm delik deler.	6,87 kg	620 x 140 x 940 mm 	1.631,00



KOD	AÇIKLAMA	AĞIRLIK	EBATLAR	AD. / ʈ
ŞAFA - MRK-2	2 çeşit ray (35x7,5 - 35x15) keser ve raya Ø 5,5 mm delik deler.	7,20 kg	620 x 140 x 940 mm 	2.266,00

DIN EN 50 022 ve DIN EN 50 045 uygun rayları ve 3x30 mm bakır baraları keser. Ayrıca Ø 5,5 mm delik deler.

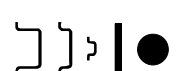

KOD	AÇIKLAMA	AĞIRLIK	EBATLAR	AD. / ʈ
ŞAFA - MRK-4	3 çeşit ray (5,5x15-7,5x35-15x35) ve 3x30 mm bakır barayı keser. Raya Ø 5,5 mm delik deler	16,17 kg	960 x 160 x 1200 mm 	2.556,00

DIN EN 50 022 ve DIN EN 50 045 uygun rayları ve 3x30 mm bakır baraları keser. Ayrıca Ø 5,5 mm delik deler.

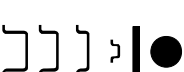

KOD	AÇIKLAMA	AĞIRLIK	EBATLAR	AD. / ʈ
ŞAFA - MRK-5	4 çeşit ray (5,5x15-7,5x35-10x35-15x35) ve 3x30 mm bakır barayı keser. Raya Ø 5,5 mm delik deler	16,15 kg	960 x 160 x 1200 mm 	2.900,00

DIN EN 50 022 ve DIN EN 50 045 uygun rayları ve 3x30 mm bakır baraları keser. Ayrıca Ø 5,5 mm delik deler.

MEKANİK PVC KANALET MAKASI

ŞAFAKSAN ranel®



KOD	MAX. KESME (EN)	CETVEL BOY AYARI	AĞIRLIK	EBATLAR	AD. / ʈ
ŞAFA - PKM 125	125 mm	50 cm	6,00 kg	22 x 59 x 63 cm	2.352,00

KABLO SIYIRICILARI



KOD	SIYIRMA ARALIĞI	SIYIRMA BIÇAĞI	AĞIRLIK	BOY	AD. / ʈ
ŞAFA - SKS-40	Ø 16,00 - 40,00 mm	Bilenebilir Çelik Alaşımli	0,200 kg	165 mm	748,00
XLP kabloların üzerindeki karbon tabakasını sıyrır.					

KOD	SIYIRMA ARALIĞI	SIYIRMA BIÇAĞI	AĞIRLIK	BOY	AD. / ʈ
ŞAFA - SKS-60	Ø 20,00 - 60,00 mm	Bilenebilir Çelik Alaşımli	1,760 kg	200 mm	988,00
XLP kabloların üzerindeki karbon tabakasını sıyrır. Polietilen tabakayı helisel şekilde soyar.					

BRANDA TAŞIMA ÇANTALARI



1 No'lu Çanta Ölçüsü (16x38 cm)		AD. / ʈ
Çanta ile taşınabilecek ürünler		55,00
KSP-50	Sıkma Pensesi	
DEK-16	Kaldıraç	
KM-35	Kablo Makası	
KM-22	Kablo Makası	
HSB-400	Sıkma Başlığı	
HSB-300	Sıkma Başlığı	
HSB-300 U	Sıkma Başlığı	
HSB-300 CM	Sıkma Başlığı	
HSB-400 U	Sıkma Başlığı	
HPB-140	Çektirme Başlığı	

2 No'lu Çanta Ölçüsü (18x58 cm)		AD. / ʈ
Çanta ile taşınabilecek ürünler		62,00
HSP-300	Sıkma Pensesi	
CM-10	Çelik Halat Makası	
HSP-240	Sıkma Pensesi	
HMB-85	Sıkma Başlığı	
HMB-65	Sıkma Başlığı	
HPP-700	Hidrolik Punch Pompası	

3 No'lu Çanta Ölçüsü (22x67 cm)		AD. / ʈ
Çanta ile taşınabilecek ürünler		69,00
KSP-150	Sıkma Pensesi	
CSP-25	Çelik Yüksük Sıkma	
KSP-85	Sıkma Pensesi	
KSP-240	Sıkma Pensesi	
KSP-10/240	Sıkma Pensesi	
KSP-10/300	Sıkma Pensesi	
HSP-400	Sıkma Pensesi	

4 No'lu Çanta Ölçüsü (21x77 cm)		AD. / ʈ
Çanta ile taşınabilecek ürünler		83,00
HKM-85	Kablo Makası	
HKM-65	Kablo Makası	
KM-55	Kablo Makası	

METAL TAŞIMA ÇANTALARI

ŞAFKSAK RANEL®



KOD	AÇIKLAMA	AĞIRLIK	EBATLAR	AD. / ₺
ŞAFA - TC-45	0,80 DKP sac	4,00 kg	670 x 195 x 70 mm	235,00
CSP-25, KSP-85, KSP-150, KP-240, KSP-10/240, KSP-10/300 el aletleri için kullanılır.				



KOD	AÇIKLAMA	AĞIRLIK	EBATLAR	AD. / ₺
ŞAFA - TC-40	0,80 DKP sac	2,50 kg	540 x 175 x 70 mm	152,00
HSP-240 hidrolik sıkma pensesi için				
ŞAFA - TC-42	0,80 DKP sac	3,30 kg	610 x 175 x 70 mm	186,00
HSP-300 hidrolik sıkma pensesi için				



KOD	AÇIKLAMA	AĞIRLIK	EBATLAR	AD. / ₺
ŞAFA - TC-50	0,80 DKP sac	4,70 kg	695 x 200 x 125 mm	345,00
HSP-10/300, HPC-E, HEP-700 hidrolik sıkma penseleri için				
ŞAFA - TC-60	0,80 DKP sac	5,00 kg	695 x 200 x 135 mm	386,00
HKM-85 E, HKM-65 E, HSP-300 CMA, HPC-A, HEP-1000, HSP-10/400, hidrolik sıkma penseleri için				



KOD	AÇIKLAMA	AĞIRLIK	EBATLAR	AD. / ₺
ŞAFA - TC-70	0,80 DKP sac	3,00 kg	80 x 500 x 280 mm	235,00
HPP-9/48, HPP-16/48 el aletleri için uygundur.				



KOD	AÇIKLAMA	KALDIRMA KAPASİTESİ TON / ÇİFT	MAKARA ÇAPI MAX. (mm)	TAŞIMA ÇANTA SANDIĞI ÖLÇÜSÜ (mm)	SET AĞIRLIĞI (kg)	AD. / ʘ	
ŞAFA - DEK-16	Ø16 mm hasır demiri kaldırır. Boy: 370 mm	-	-	-	0,55	293,00	
ŞAFA - REK-60	Ranel elcik-kaldıraç, kablo düzenleyici. Boyutları: 120 x 720 mm	-	-	-	0,50	132,00	
ŞAFA - VK-1000/SET	* 2 ad. VK-1000A Kaldıraç Vidalı * 2 ad. SB-76/130 Sabitleme	* 1 ad. MLG-1000 Aks Mili * 1 ad. TS-1000 Taşıma Çantası	1,10	700-1000	361x341x280	32,00	2.415,00
ŞAFA - HRK-1100/SET	* 2 ad. HRK-1100A Hidrolik Kaldıraç * 2 ad. SB-76/130 Sabitleme	* 1 ad. MLR-1000 Rotasyonlu Aks Mili * 2 ad. TY-52/160 Taşıyıcı Yatak	1,30	500-1100	270x900x370	32,00	2.760,00
ŞAFA - HRK-1800/SET	* 2 ad. HRK-1800A Hidrolik Kaldıraç * 2 ad. MS-76/125 Mer. ve Sab.	* 1 ad. MLR-1600 Rotasyonlu Aks Mili * 2 ad. TY-52/160 Taşıyıcı Yatak	3,50	500-1800	600x105x50	62,00	3.795,00
ŞAFA - HRK-2500/SET	* 2 ad. HRK-2500A Hidrolik Kaldıraç * 2 ad. MS-76/125 Mer. ve Sab.	* 1 ad. MLR-2000 Rotasyonlu Aks Mili * 2 ad. TY-68/160 Taşıyıcı Yatak	7,00	800-2500	580x480x700 (2 adet)	90,00	4.370,00



DEK-16



REK-60



HRK SERİSİ



VK-1000/SET



HS-700D



0.25 - 2.5 mm² Kablo Sıyırma Pensesi

HSC86A-4A (YAC-8)



0.25 - 6 mm² Yüksük Sıkma Pensesi

HS-30J (YYT-7)



0.50, 1.5, 2.5, 4-6 mm² İzoleli Kablo Ucu Sıkma Pensesi

YYT-21



0,75 - 10 mm² Yüksük Sıkma Pensesi

YYT-22

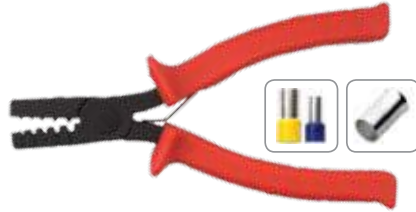

0,50 - 2,5 mm² Yüksük Sıkma Pensesi

KY-3207



0,50 - 16 mm² Yüksük Sıkma Pensesi

NWS-16



0.50 - 16mm² Yüksük Sıkma Pensesi

YAC-8



Dörtgen / 0,08 - 6 mm² Yüksük Sıkma Pensesi

YAC-9



Altıgen / 0,08 - 6 mm² Yüksük Sıkma Pensesi

YAC-5



0,50 - 6 mm² Yüksük Sıkma Pensesi

YAC-6



6 - 16 mm² Yüksük Sıkma Pensesi

YYT-B4



0,50 - 6 mm² Yüksük Sıkma Pensesi

YYT-B6



6 - 10 - 16 mm² Yüksük Sıkma Pensesi

YAC-17



25 - 35 mm² Yüksük Sıkma Pensesi

YYT-7



0,5 - 6 mm² İzoleli Papuç Sıkma Pensesi

YYT-1



0,5 - 10 mm²
İzoleli Papuç Sıkma Pensesi

HD-0560



0,5 - 6 mm²
İzoleli Papuç Sıkma Pensesi

HD-FLAG



0,5 - 2,5 mm² Bayrak Tip
İzoleli Terminal Pensesi

YAC-16



Eğri Terminal Sıkma Pensesi

YYT-11



0,50 - 6 mm²
İzolesiz Papuç Sıkma Pensesi

YYT-12



1,5-2,5/4-6/8-10 mm²
İzolesiz Papuç Sıkma Pensesi

HD-F0560



0,50 - 6 mm²
İzolesiz Papuç Sıkma Pensesi

YYT-B10



0,08 - 0,8 mm² AWG
28 - 18 Konnektör Terminal Pensesi

YAC-12/13

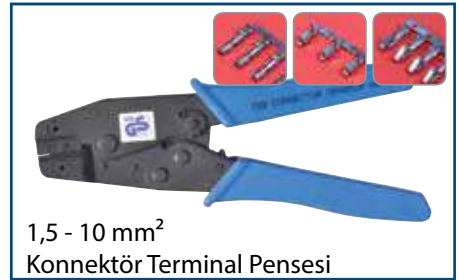

1,5 - 10 mm²
Konnektör Terminal Pensesi

YAC-4



18 - 22 / 24 - 30 AWG
Konnektör Terminal Pensesi

HD-11010



AWG 14 -24
Konnektör Terminal Pensesi

HD-11011



AWG 24 -30 / 16 - 22
Konnektör Terminal Pensesi

HD-SWLK



Çelik Tel Kilitleme
Konnektör Pensesi

YYT-15



Kablo Kapama
Sıkma Pensesi - AWG 10-12

YYT-8



1,5 - 10 mm² SKP Sıkma Pensesi

YYT-9



10 - 16 mm² SKP Sıkma Pensesi

JOKARI-10280 - 10282



0,4 - 28 mm² arası NYY-NYM
Yuvarlak Kablo Soyma

JOKARI-20050



1 - 6 mm² Kablo Soyma Pensesi

YY-78/318



0,50 - 6 mm² Kablo Soyma Pensesi

KP-6



0,03 - 10 mm² Kablo Soyma Pensesi

TP-700A

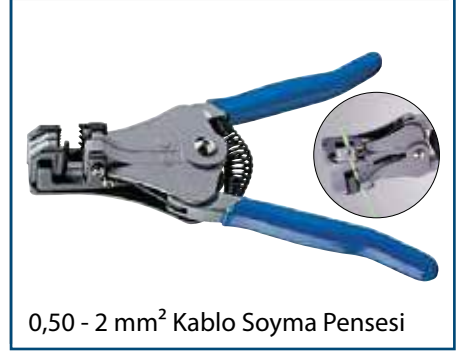

0,50 - 2 mm² Kablo Soyma Pensesi

TP-700B



1,00 - 3,20 mm² Kablo Soyma Pensesi

8PK-371D



0,20 - 6 mm² Kablo Soyma Pensesi

KY-683N



0,20 - 6 mm² Kablo Soyma Pensesi

TRE-03NB



Elektronikçi Yan Keski

6PK-223



AWG 14 -24
Konnektör Terminal Pensesi

CC-08



10 mm² Kablo Kesme Makası

CC-38 S



38 mm² Bakır ve Alüminyum
Kablo Keser

CC-60



60 mm² Bakır ve Alüminyum
Kablo Keser

YYR-504 - CC-38



1 - 38 mm² Bakır ve Alüminyum
Kablo Keser

700 020 36



20 ~ 70 mm² Kablo Kesme

TCR-325



32 ~ 150 mm² Bakır Kablo Kesme

YJR-513



60 mm² Bakır ve Alüminyum Kablo Keser

ZC-36A

ZC-52A



300 mm² Bakır ve Alüminyum Kablo Kesme Makası
500 mm² Bakır ve Alüminyum Kablo Kesme Makası

CC-80



80 mm² Bakır ve Alüminyum Kablo Keser

CC-250



250 mm² Bakır ve Alüminyum Kablo Keser

CC-500



500 mm² Bakır ve Alüminyum Kablo Keser

HY-376E



8P8C/6P6C/6P4C - Pluk Sıkma Pensesi

HT-200



Modüller (4P-4C), (6P-6C), (8P-8C) Pluk Sıkma Pensesi

YTT-02



Modüller (4P-4C), (6P-6C), (8P-8C) Pluk Sıkma Pensesi

YAC-3



1,72 - 8,2 mm² BNC Konnektör Sıkma Pensesi

YAC-10



RG-59 / RG-6 BNC Konnektör Sıkma Pensesi

TG-008



2,2 - 4,8 mm Kablo Bağı Sıkma Pensesi

TG-009



3,6 - 9,0 mm Kablo Bağı Sıkma Pensesi

TG-011



4,6 - 12 mm Çelik Kablo Bağı Sıkma Pensesi

GIT-705



4,8 - 7,6 mm Çelik Kablo Bağı Sıkma Pensesi

KG-0650



6,0 - 50 mm² SKP Sıkma Pensesi
(Döner Çene)

CC-KG-10120



10,0 - 120 mm² SKP Sıkma Pensesi
(Döner Çene)

YYR-510



8,0 - 25 mm² SKP Sıkma Pensesi

YQK-70



4 - 70 mm² Hidrolik Alüminyum ve
Bakır Kablo Papuç Sıkma Pensesi

YQK-120



10 - 120 mm² Hidrolik Alüminyum ve
Bakır Kablo Papuç Sıkma Pensesi

YQK-240



16 - 240 mm² Hidrolik Alüminyum ve
Bakır Kablo Papuç Sıkma Pensesi

YQK-300



10 - 300 mm² Hidrolik Alüminyum ve
Bakır Kablo Papuç Sıkma Pensesi

YQK-70



4 - 70 mm² Hidrolik Alüminyum ve
Bakır Kablo Papuç Sıkma Pensesi

YQK-120A



10 - 120 mm² Hidrolik Alüminyum ve
Bakır Kablo Papuç Sıkma Pensesi

YQK-240



10 - 120 mm² Hidrolik Alüminyum ve
Bakır Kablo Papuç Sıkma Pensesi



16 - 240 mm² SKP
Hidrolik Papuç Sıkma Pensesi

YQK-300



10 - 300 mm² SKP
Hidrolik Papuç Sıkma Pensesi

HZ-300



16 - 300 mm² Hidrolik Alüminyum ve
Bakır Kablo Papuç Sıkma Pensesi

HZ-400



16 - 400 mm² Hidrolik Alm. ve
Bakır Kablo Papuç Sıkma Pensesi

ONKA TORNAVİDA MUHTEVİYATI



KOD	☉	AD./ ʘ	K/AD.
ONKA 190	190 mm Kontrol Kalemi	2,65	3
ONKA 4 x 100	4 x 100 Düz Tornavida	4,30	3
ONKA 3 x 80	3 x 80 Düz Tornavida	3,90	3

ONKA TORNAVİDA MUHTEVİYATI



KOD	☉	AD./ ʘ	K/AD.
ONKA T SET	3x80 - 4x100 Düz Tornavida 190 mm Kontrol Kalemi	13,50	1

KONTROL KALEMLERİ (Düz ve Yıldız)



KOD	ÖLÇÜ (mm)	AD./ ʘ	K/AD.
MEGA-4190	Dövme Uçlu	1,75	40/800
MEGA-4191	Klemens Uçlu	1,90	40/800
MEGA-4192-Y	Yıldız Uçlu	1,99	40/800

DÜZ UÇLU TORNAVİDALAR



KOD	ÖLÇÜ (mm)	UK (mm)	AD./ ʘ	K/AD.
MEGA-1113080	3 x 80	0,5	2,60	12
MEGA-1113100	3 x 100	0,5	2,80	12
MEGA-1114100	4 x 100	0,8	2,85	12
MEGA-1114125	4 x 125	0,8	3,25	12
MEGA-1114150	4 x 150	0,8	3,30	12
MEGA-1115100	5 x 100	1,0	3,40	12
MEGA-1115125	5 x 125	1,0	3,55	12
MEGA-1115150	5 x 150	1,0	3,70	12
MEGA-1116100	6 x 100	1,2	3,85	12
MEGA-1116125	6 x 125	1,2	3,95	12
MEGA-1116150	6 x 150	1,2	4,15	12
MEGA-1117125	7 x 125	1,3	5,60	12
MEGA-1117150	7 x 150	1,3	6,10	12
MEGA-1118150	8 x 150	1,4	7,00	12
MEGA-1118175	8 x 175	1,4	7,75	12

YILDIZ UÇLU TORNAVİDALAR



KOD	ÖLÇÜ (mm)	UK (mm)	AD./ ʘ	K/AD.
MEGA-1123080	3 x 80	0,5	2,60	12
MEGA-1123100	3 x 100	0,5	2,80	12
MEGA-1124100	4 x 100	1	2,85	12
MEGA-1124125	4 x 125	1	3,25	12
MEGA-1124150	4 x 150	1	3,30	12
MEGA-1125100	5 x 100	1	3,40	12
MEGA-1125125	5 x 125	1	3,55	12
MEGA-1125150	5 x 150	1	3,70	12
MEGA-1126100	6 x 100	2	3,85	12
MEGA-1126125	6 x 125	2	3,95	12
MEGA-1126150	6 x 150	2	4,15	12
MEGA-1127125	7 x 125	3	5,60	12
MEGA-1127150	7 x 150	3	6,10	12
MEGA-1128150	8 x 150	3	7,00	12
MEGA-1128175	8 x 175	3	7,75	12

LOKMA UÇLU TORNAVİDALAR



KOD	ÖLÇÜ (mm)	AD./ ʘ	K/AD.
MEGA-150055	5,5 x 150	8,25	12
MEGA-150060	6 x 150	8,25	12
MEGA-150070	7 x 150	8,25	12
MEGA-150080	8 x 150	8,70	12
MEGA-150090	9 x 150	8,70	12
MEGA-150100	10 x 150	8,70	12
MEGA-150110	11 x 150	9,25	6
MEGA-150120	12 x 150	9,25	6
MEGA-150130	13 x 150	9,25	6
MEGA-150140	14 x 150	9,25	6
MEGA-150170	17 x 150	10,50	12

TORNAVİDA SETLERİ



KOD	ÖLÇÜ (mm)	AD./ ʘ	K/AD.
MEGA-11137S	Takım 7 Parça Düz: 3 x 100 - 5 x 125 - 6 x 125 - 7 x 150 Yıldız: 3 x 80 - 5 x 100 - 6 x 125	24,75	30
MEGA-11135D	Takım Düz 5 Parça Düz: 3 x 100 - 4 x 100 - 5 x 100 - 6 x 125 - 7 x 125	18,00	30
MEGA-11135Y	Takım Yıldız 5 Parça Yıldız: 3 x 100 - 4 x 100 - 5 x 100 - 6 x 125 - 7 x 125	18,00	30

BAKIR TOPRAKLAMA ÇUBUĞU ve LEVHALAR



KOD	CİNSİ
52867	Ø 14 x 1 Topraklama Çubuğu
52868	Ø 16 x 1 Topraklama Çubuğu
52869	Ø 16 x 1.5 Topraklama Çubuğu
52870	Ø 18 x 1 Topraklama Çubuğu
52871	Ø 18 x 1.5 Topraklama Çubuğu
52872	Ø 20 x 1 Topraklama Çubuğu
52873	Ø 20 x 1.5 Topraklama Çubuğu
58974	Topraklama Kelepçesi
52975	Çakma Uçları (Takım)
52976	Ara Bağlantı Redüktörü
Levha	70 x 70 x 1 mm.
Levha	70 x 70 x 1,5 mm.
Levha	70 x 70 x 2 mm.
Levha	70 x 70 x 3 mm.

BAKIR BARA, ÖRGÜLÜ BAKIR



KOD	CİNSİ
Bara	20 x 3 mm. 0.533 Kg./Mt.
Bara	25 x 3 mm. 0.666 Kg./Mt.
Bara	30 x 3 mm. 0.800 Kg./Mt.
Bara	40 x 3 mm. 1.066 Kg./Mt.
Bara	20 x 5 mm. 0.889 Kg./Mt.
Bara	25 x 5 mm. 1.111 Kg./Mt.
Bara	30 x 5 mm. 1.333 Kg./Mt.
Bara	40 x 5 mm. 1.778 Kg./Mt.
Bara	50 x 5 mm. 2.222 Kg./Mt.
Bara	40 x 10 mm. 3.556 Kg./Mt.
Bara	50 x 10 mm. 4.440 Kg./Mt.
Bara	60 x 10 mm. 5.330 Kg./Mt.
Bara	80 x 10 mm. 7.112 Kg./Mt.
Bara	100 x 10 mm. 8.890 Kg./Mt.
Bara	120 x 10 mm. 10.668 Kg./Mt.
Çıp. Örgülü	10 mm. 87 Kg./Mt.
Çıp. Örgülü	16 mm. 144 Kg./Mt.
Çıp. Örgülü	25 mm. 224 Kg./Mt.
Çıp. Örgülü	35 mm. 311 Kg./Mt.
Çıp. Örgülü	50 mm. 448 Kg./Mt.
Çıp. Örgülü	70 mm. 611 Kg./Mt.
Çıp. Örgülü	95 mm. 849 Kg./Mt.
Çıp. Örgülü	120 mm. 1064 Kg./Mt.
Çıp. Örgülü	150 mm. 1350 Kg./Mt.
Çıp. Örgülü	195 mm. 1740 Kg./Mt.
Çıp. Örgülü	240 mm. 2140 Kg./Mt.

TEHLİKE LEVHALARI



KOD	CİNSİ	AD. / t
ALM1	Alimünyum levha 14 x 21 cm	☎

İZOLE HALILAR



KOD	CİNSİ	t / m ²
İZL 1	1 Kw, 3 mm	☎
İZL 15	15 Kw, 3 mm	
İZL 35	35 Kw, 5 mm	



Izgara Bakır Topraklama

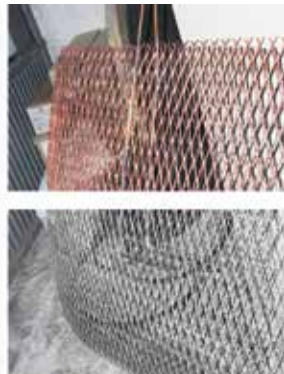

Ağ Bakır ve Çelik Topraklama

